

EXERCÍCIOS DE AULA - 02

Representação de objectos em axonometria normalizada, dadas vistas em Dupla Projecção Ortogonal (DPO)

FA.Ulisboa – Ano lectivo 2017/2018 – 1º semestre

Professor Luís Mateus (lmmateus@fa.ulisboa.pt)

Notas:

- 1) A representação dos eixos nas vistas em DPO vincula os objectos a uma orientação.
- 2) A representação dos eixos nas vistas em DPO não vincula os objectos a nenhuma posição específica relativamente à origem do referencial.
- 3) Represente sempre as arestas invisíveis com traço contínuo (distinto das linhas de construção e das arestas visíveis) ou com traço interrompido (esta opção apenas deverá ser adoptada se não prejudicar a leitura do resultado final).
- 4) Este conjunto de exercícios deverá ser resolvido nas aulas das semanas 3 e 4.
- 5) Utilize a quadrícula para definir a unidade de trabalho (ex: lado da quadrícula igual a 1cm).
- 6) Considere que cada par de vistas define apenas um objecto.
- 7) Em todos os objectos, as faces são do tipo planar e/ou cilíndrico.

U

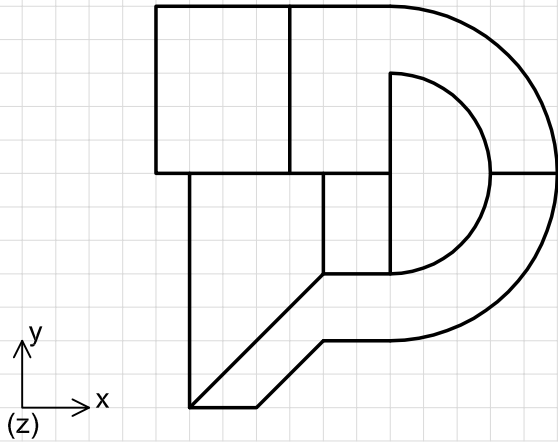
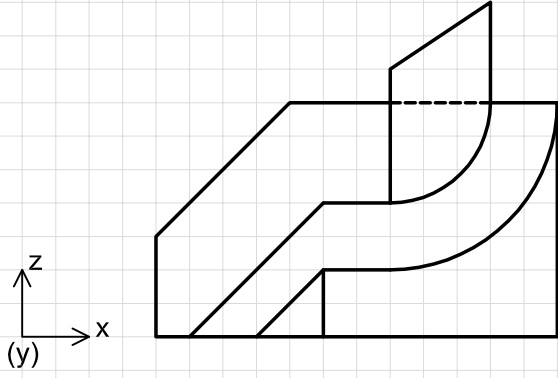

V

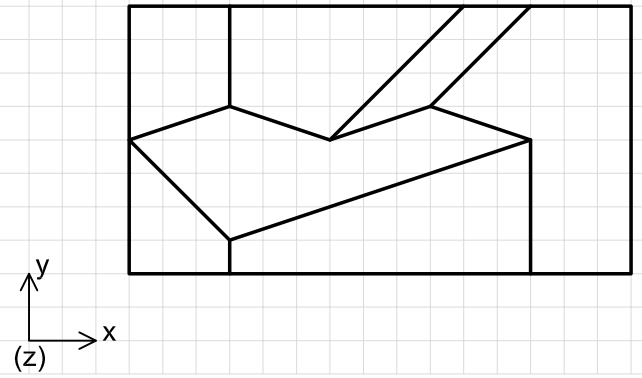
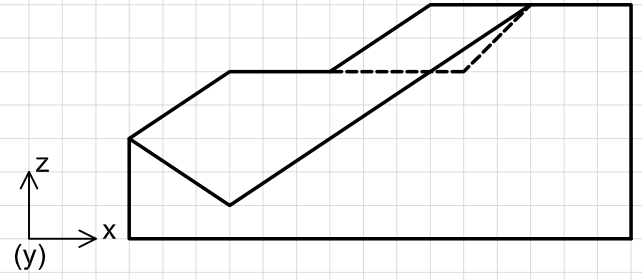

W

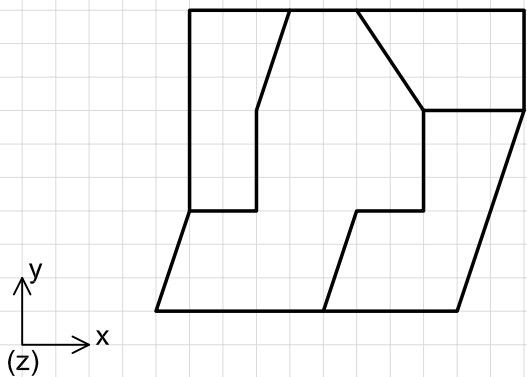
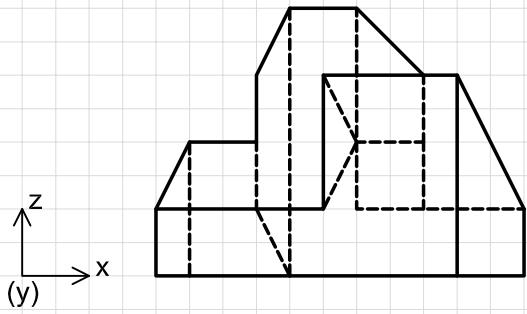

X

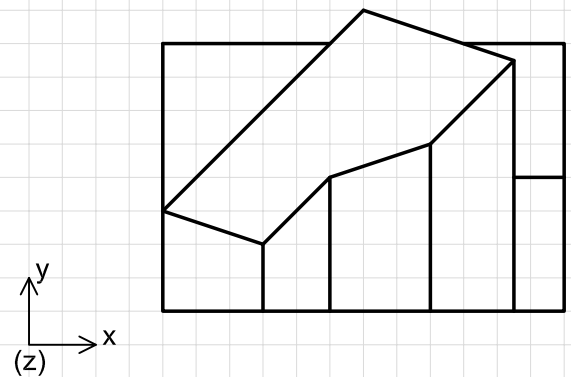
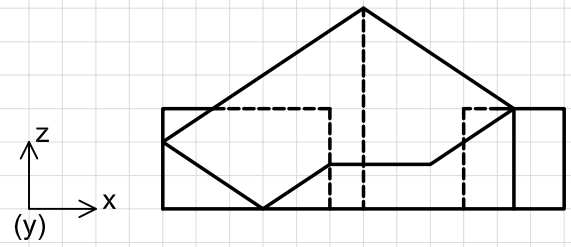

Q

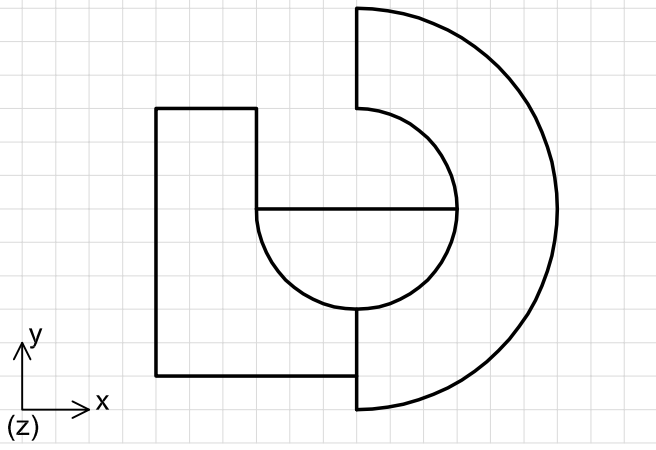
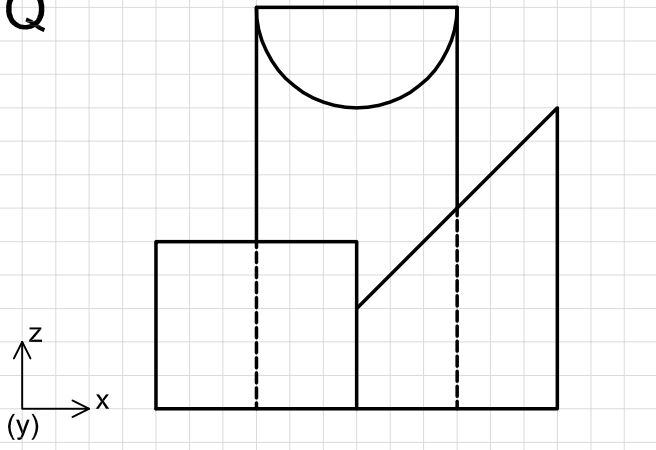

R

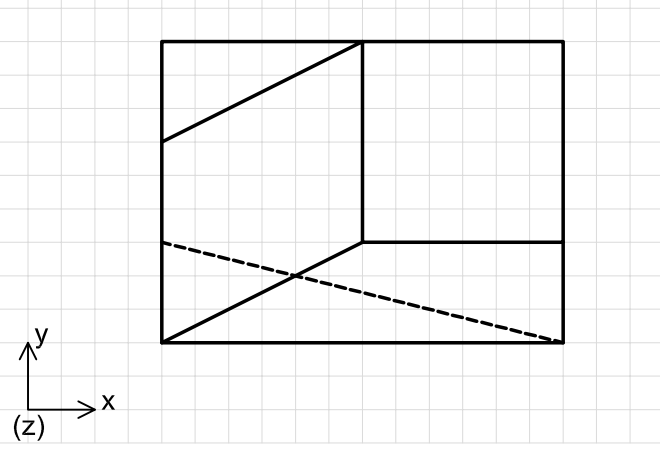
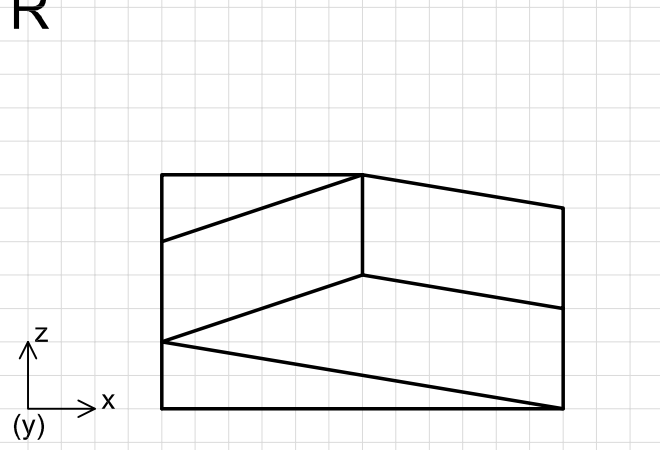

S

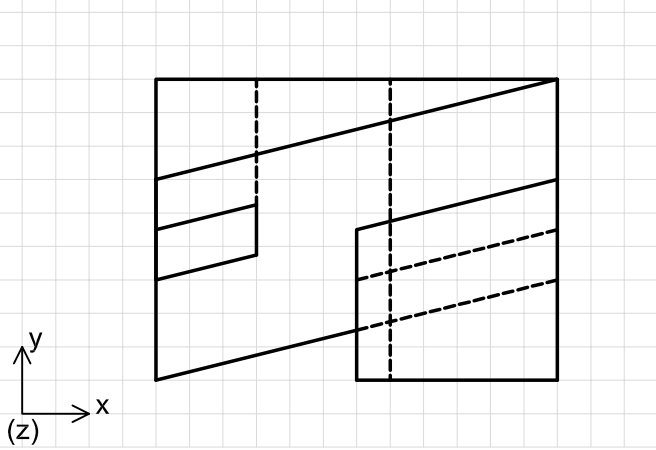
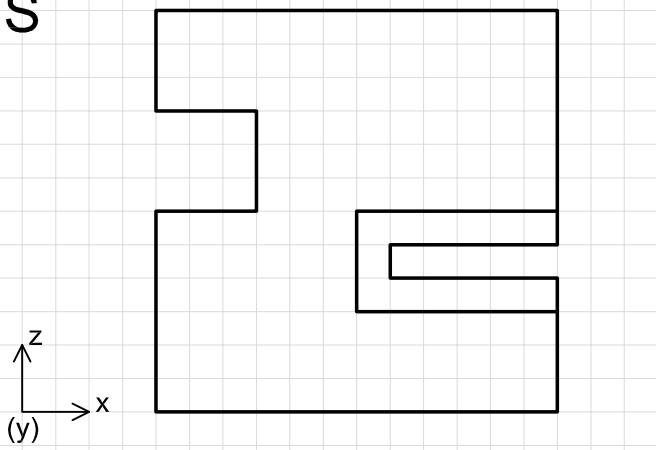

T

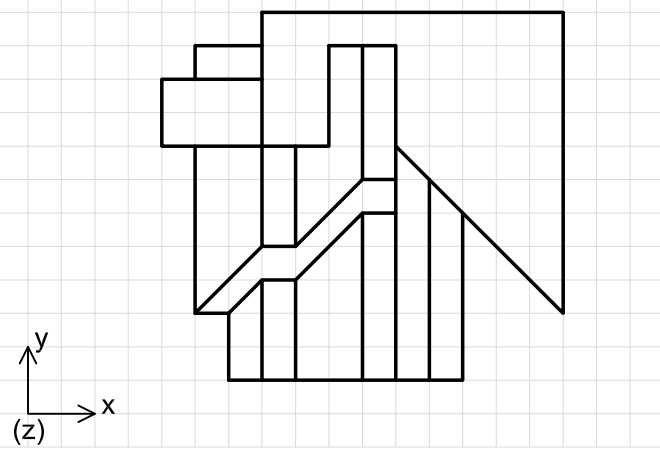
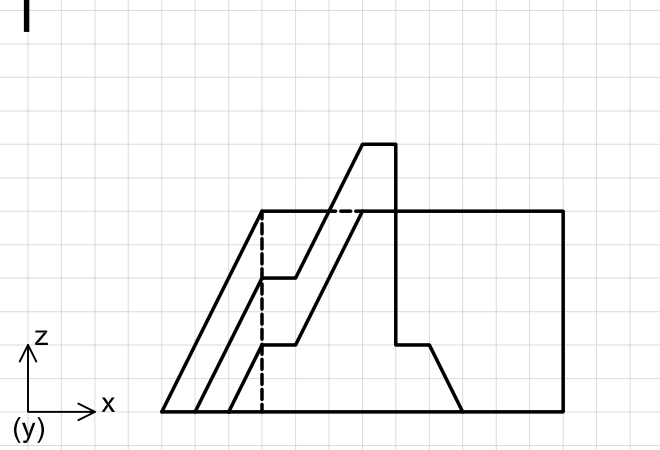

M

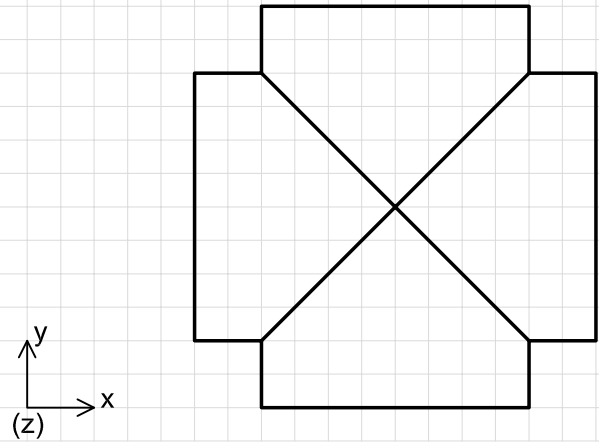
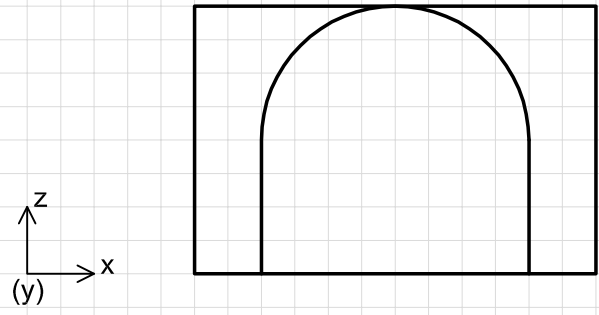

N

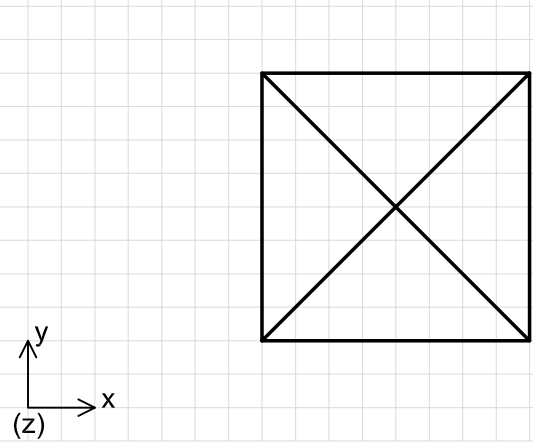
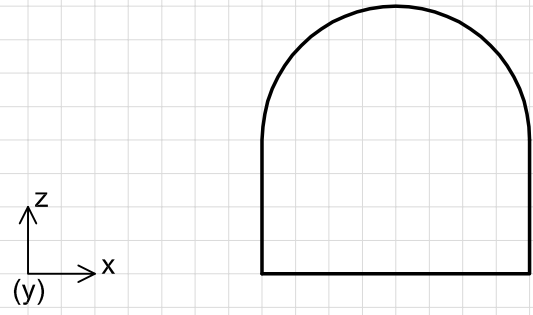

O

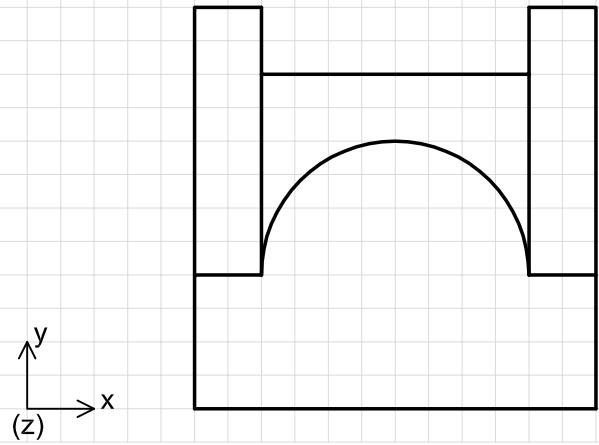
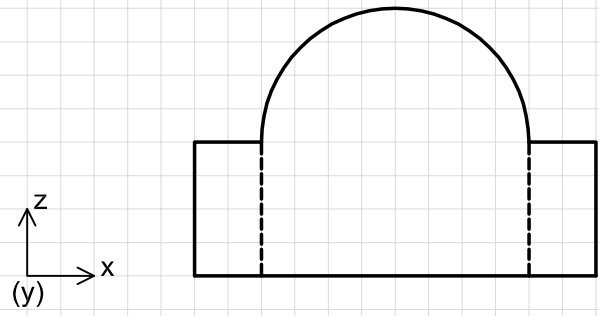

P

