

Figura 4.58 - Fases de construção de um desenho à mão livre.

4.12 EXEMPLOS APLICAÇÃO DISCUSSÃO

Na Figura 4.59 mostram-se exemplos de representação de peças.

Muitas das peças são desenhadas como se fossem desenhadas com o auxílio de uma régua e compasso, o que não é necessário, pois a dificuldade de execução de um desenho em CAD...



Figura 4.61

Muitas das peças são desenhadas como se fossem desenhadas com o auxílio de uma régua e compasso, o que não é necessário, pois a dificuldade de execução de um desenho em CAD...

Figura 4.59



Figura 4.64 - Exercícios de projecção de peças (continua).



Figura 4.64 - I

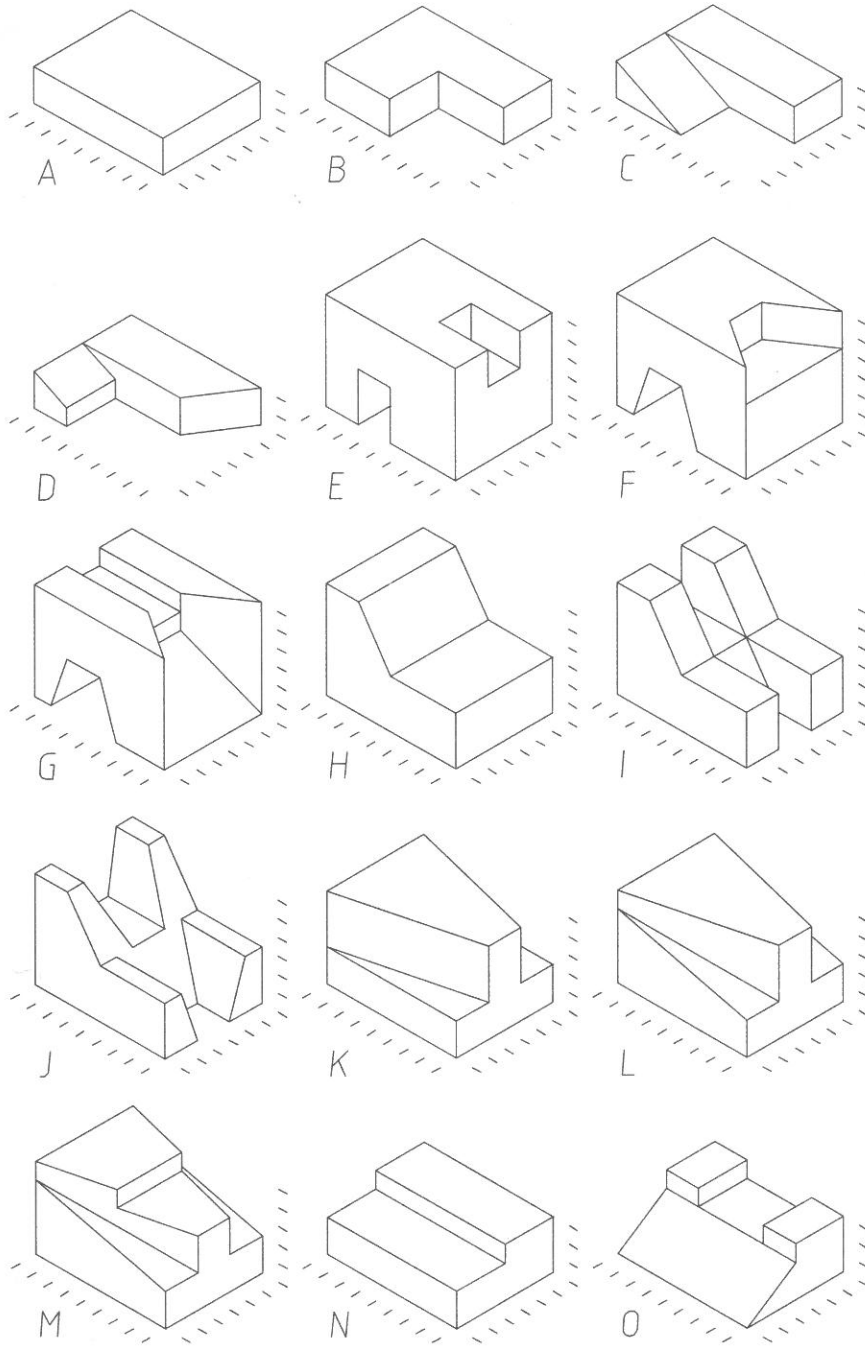

Figura 4.64 - Exercícios de projeção de peças (continuação).

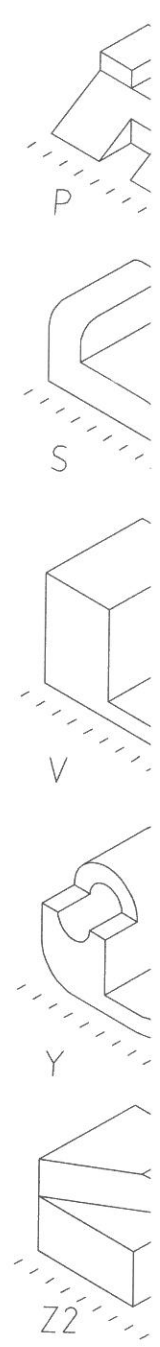

Figura 4.65 - Exercícios para completar a terceira projecção (continua).

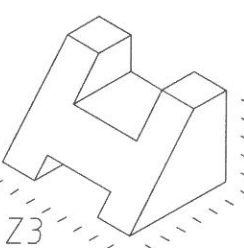
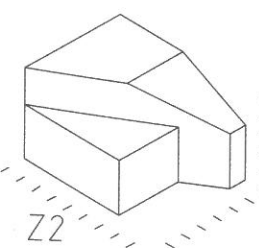
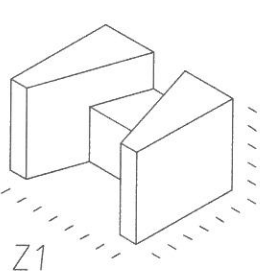
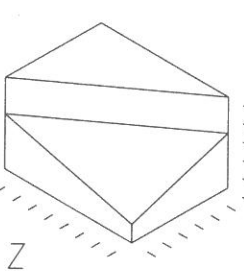
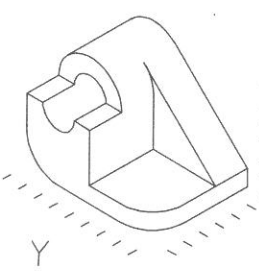
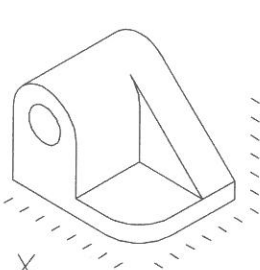
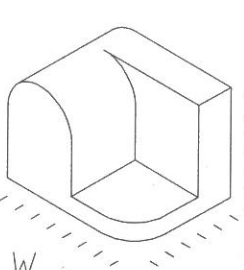
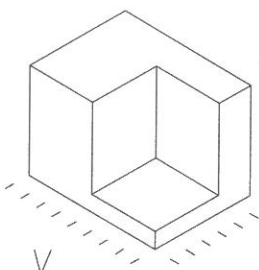
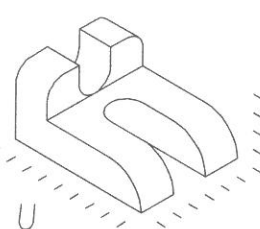
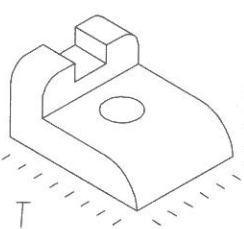
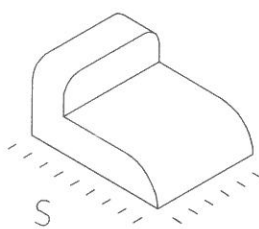
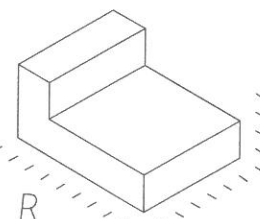
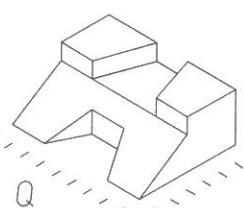
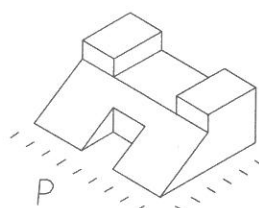
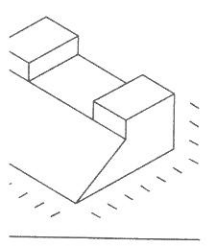
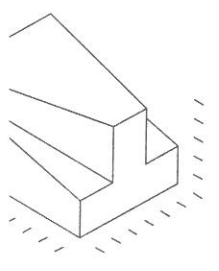
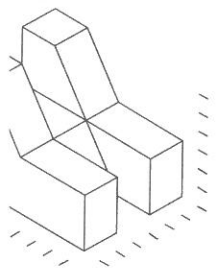
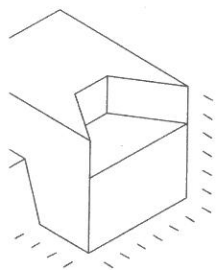
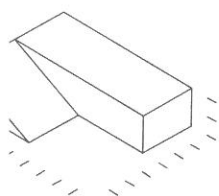

Figura 4.65 - Exercícios para com

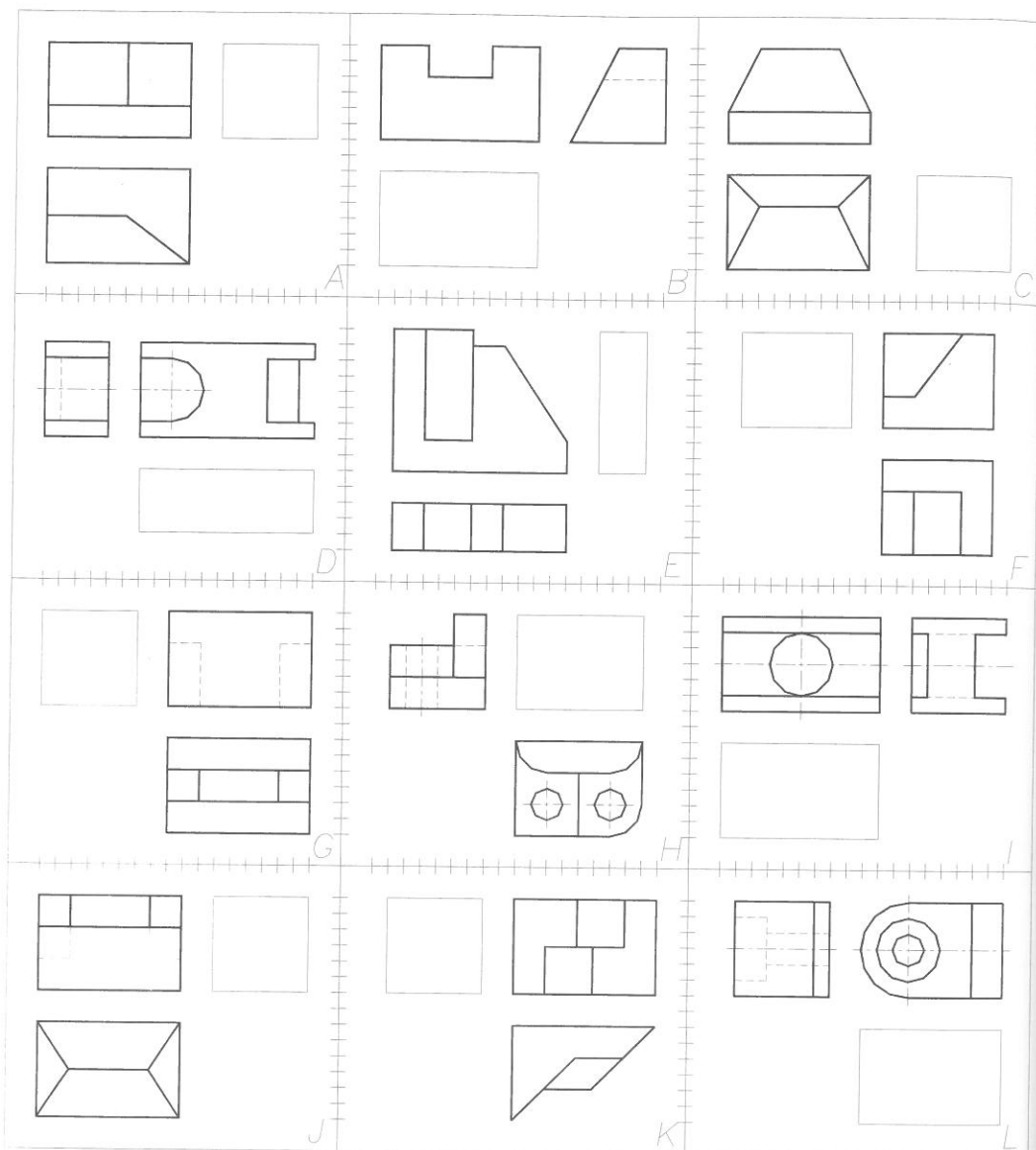
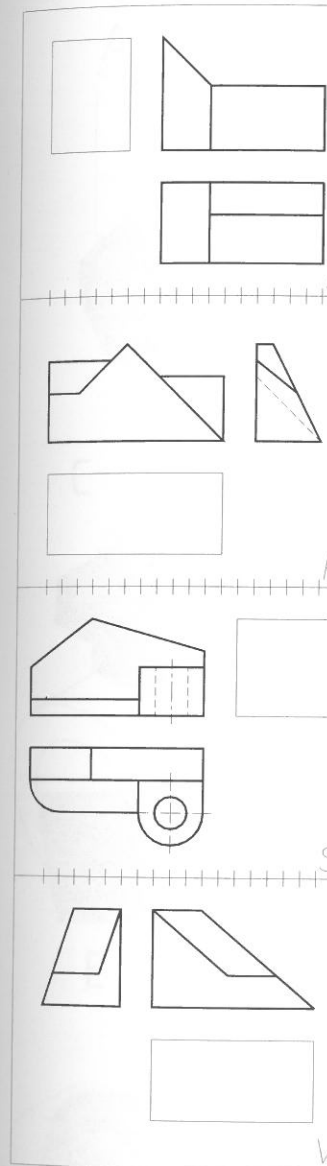
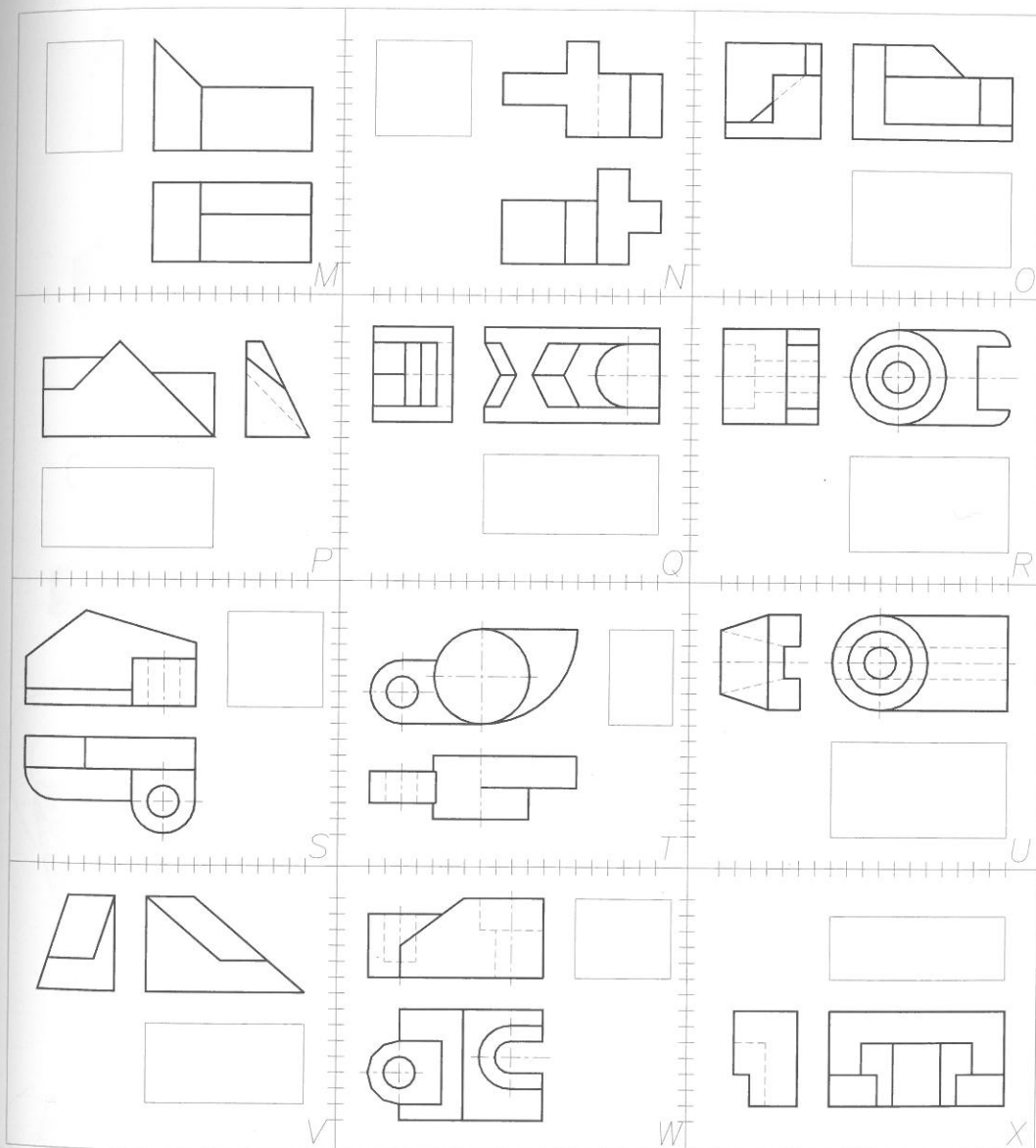
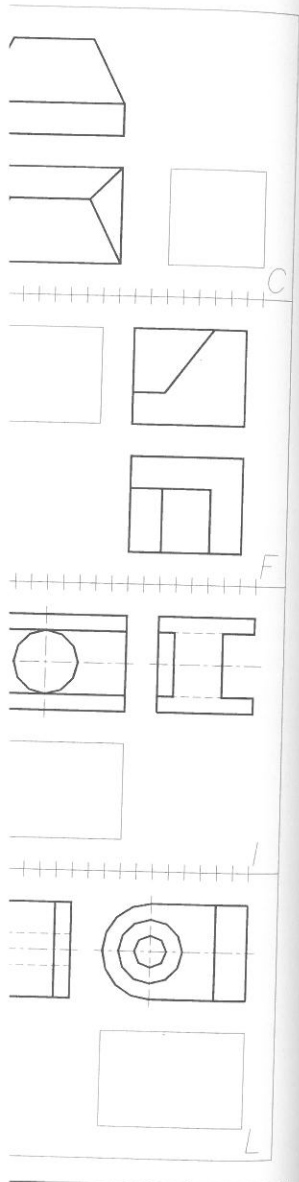

Figura 4.65 - Exercícios para completar a terceira projecção (continuação).