

EXERCÍCIOS

1 e 2

Modelação Geométrica e Generativa



al0003913



PAULO S. FERREIRA

U LISBOA

UNIVERSIDADE
DE LISBOA

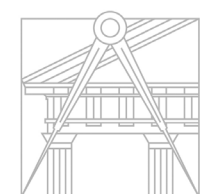

FACULDADE DE ARQUITETURA
UNIVERSIDADE DE LISBOA

MGeG

Mestrado Integrado em Arquitectura
Ano Lectivo 2021-2022 1º Semestre
Docente - Nuno Alão 4º Ano

ÍNDICE:

<u>EXERCÍCIO 1.0 – POLIEDROS</u>	04
<u>1.1 DUAL DE CUBO TRUNCADO A UM TERÇO DA ARESTA</u>	05
<u>1.2 DUAL DE DODECAEDRO TRUNCADO A UM QUARTO DA ARESTA</u>	06
<u>EXERCÍCIO 2.0 – MOLUSCOS</u>	08
<u>2.1 – SPIRULA</u>	09
<u>2.2 – PLANORBIS</u>	11
<u>2.3 – NAUTILUS</u>	13
<u>2.4 – CARACOL</u>	15
<u>2.5 – CARAMUJO</u>	17

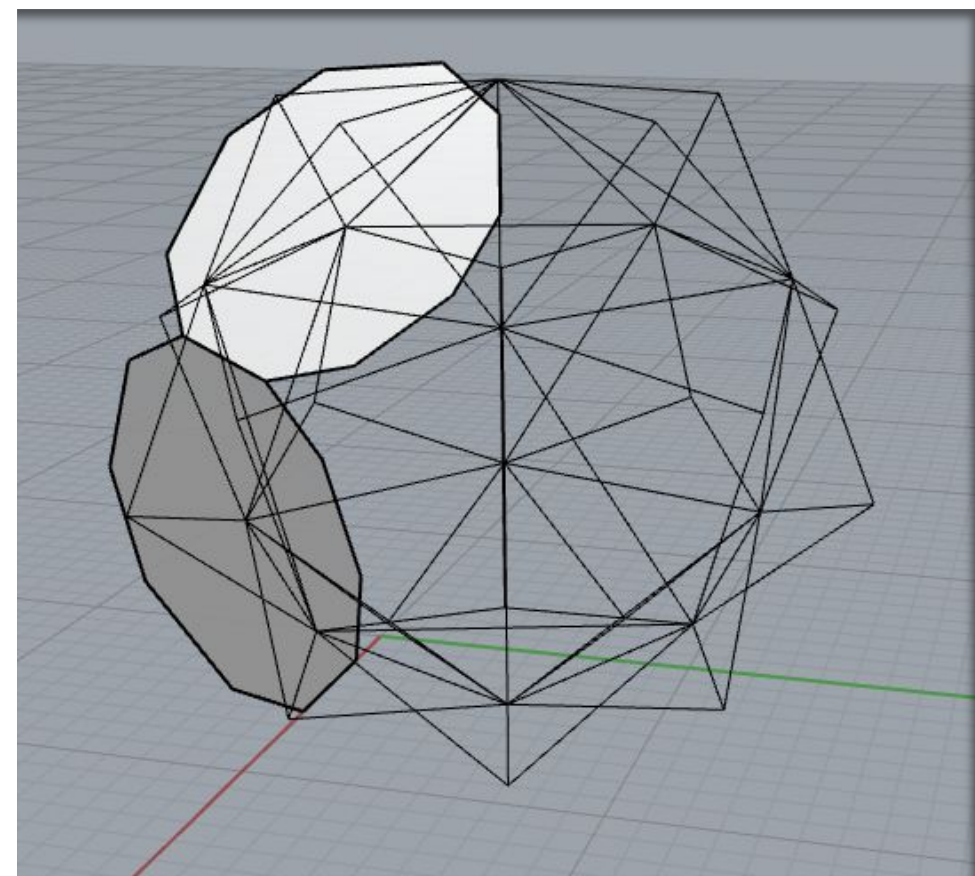
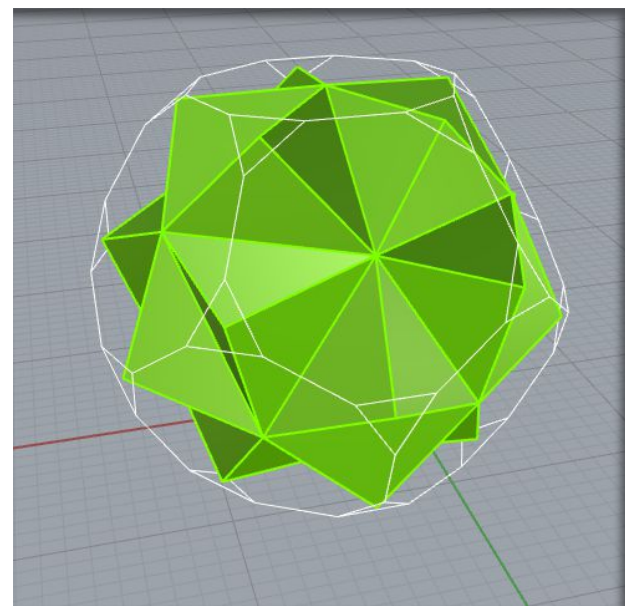
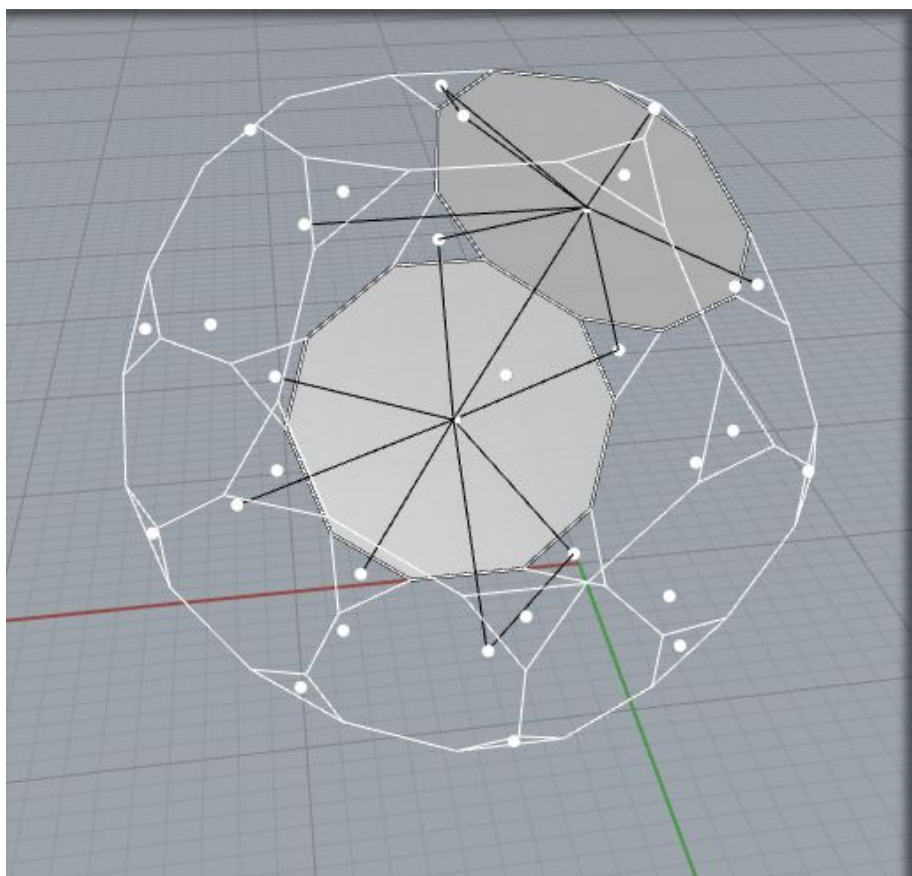
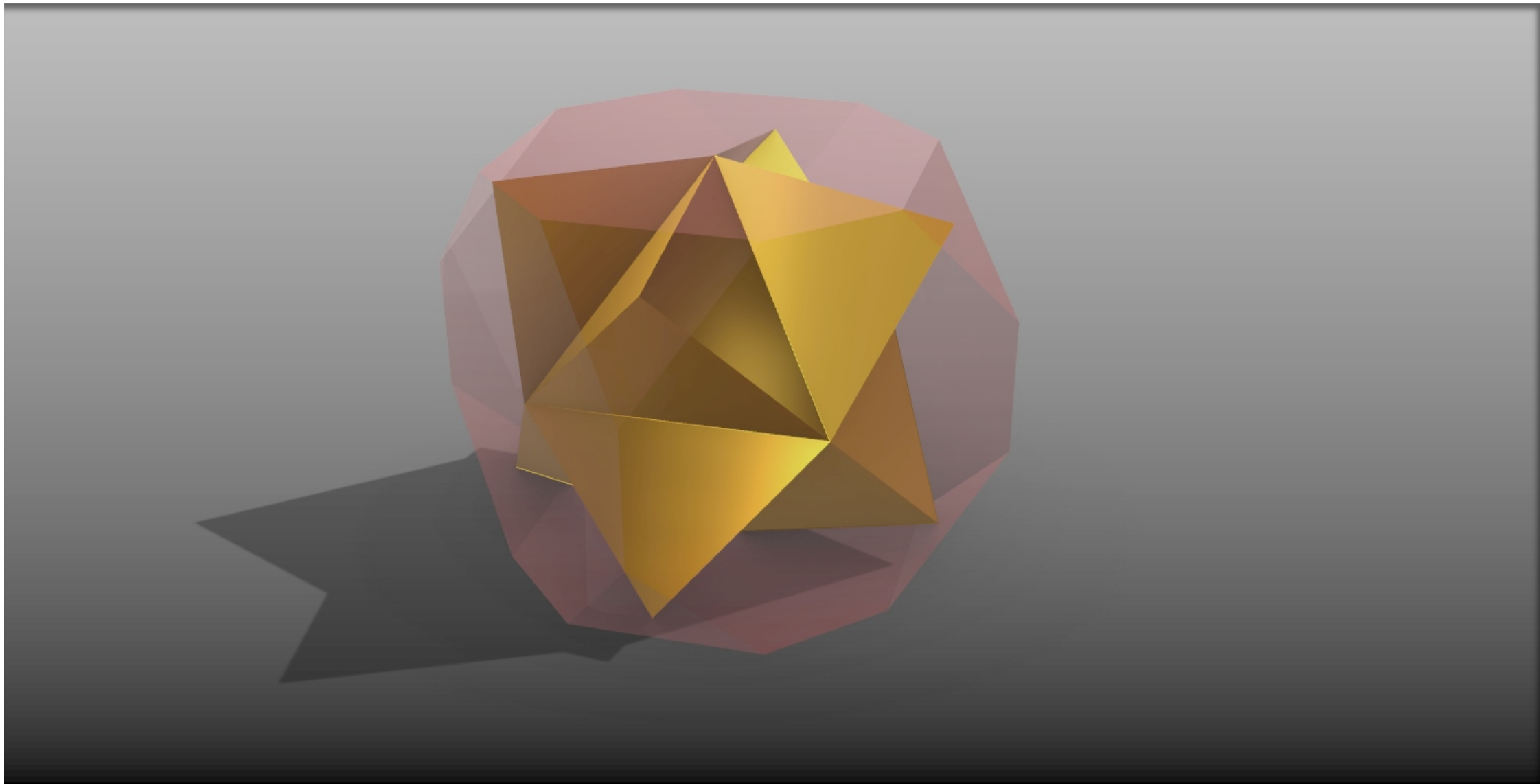

EX 02

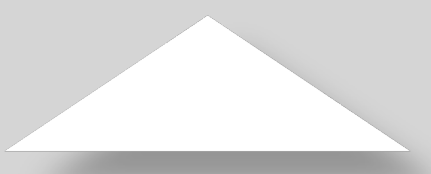
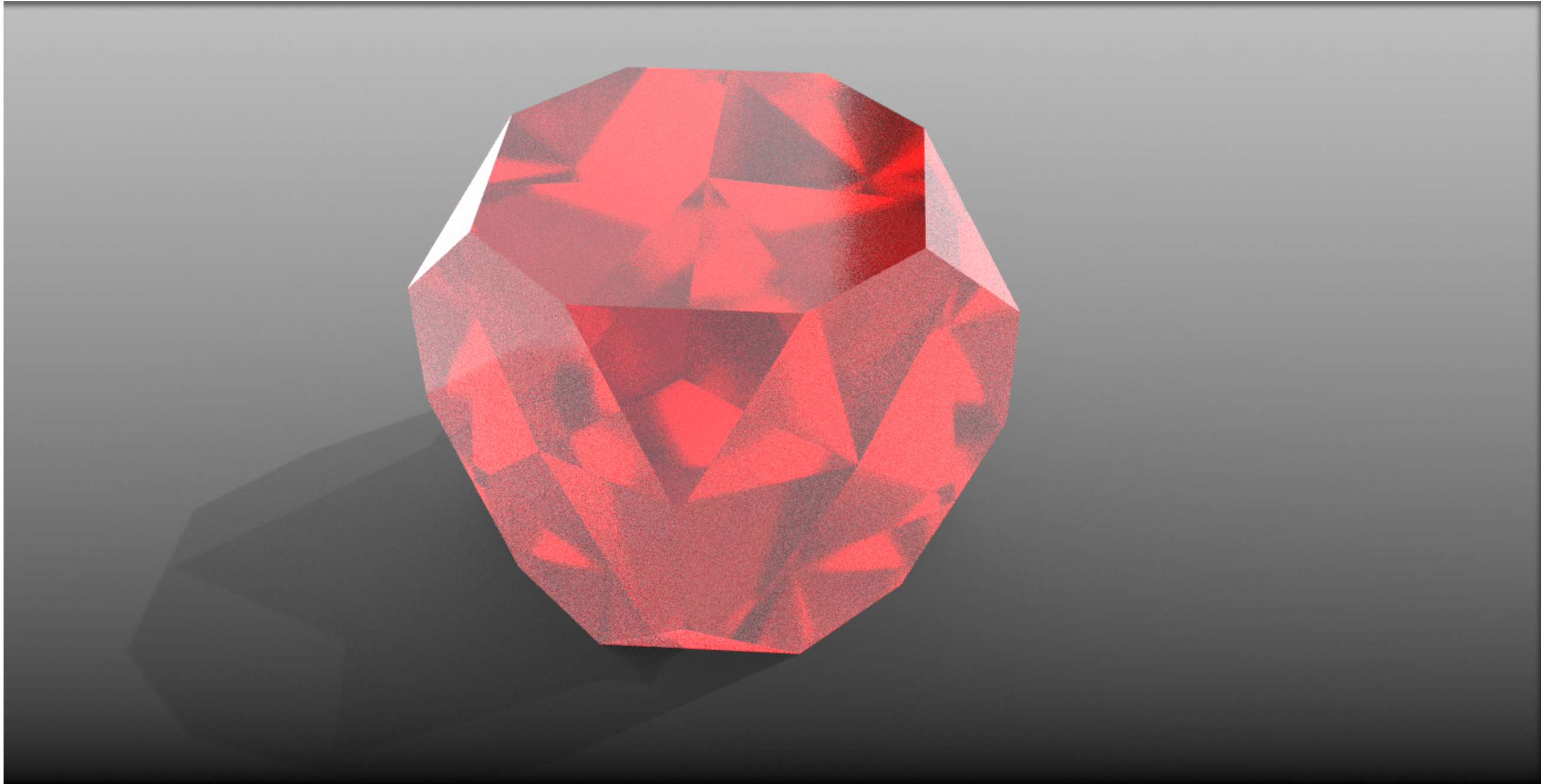
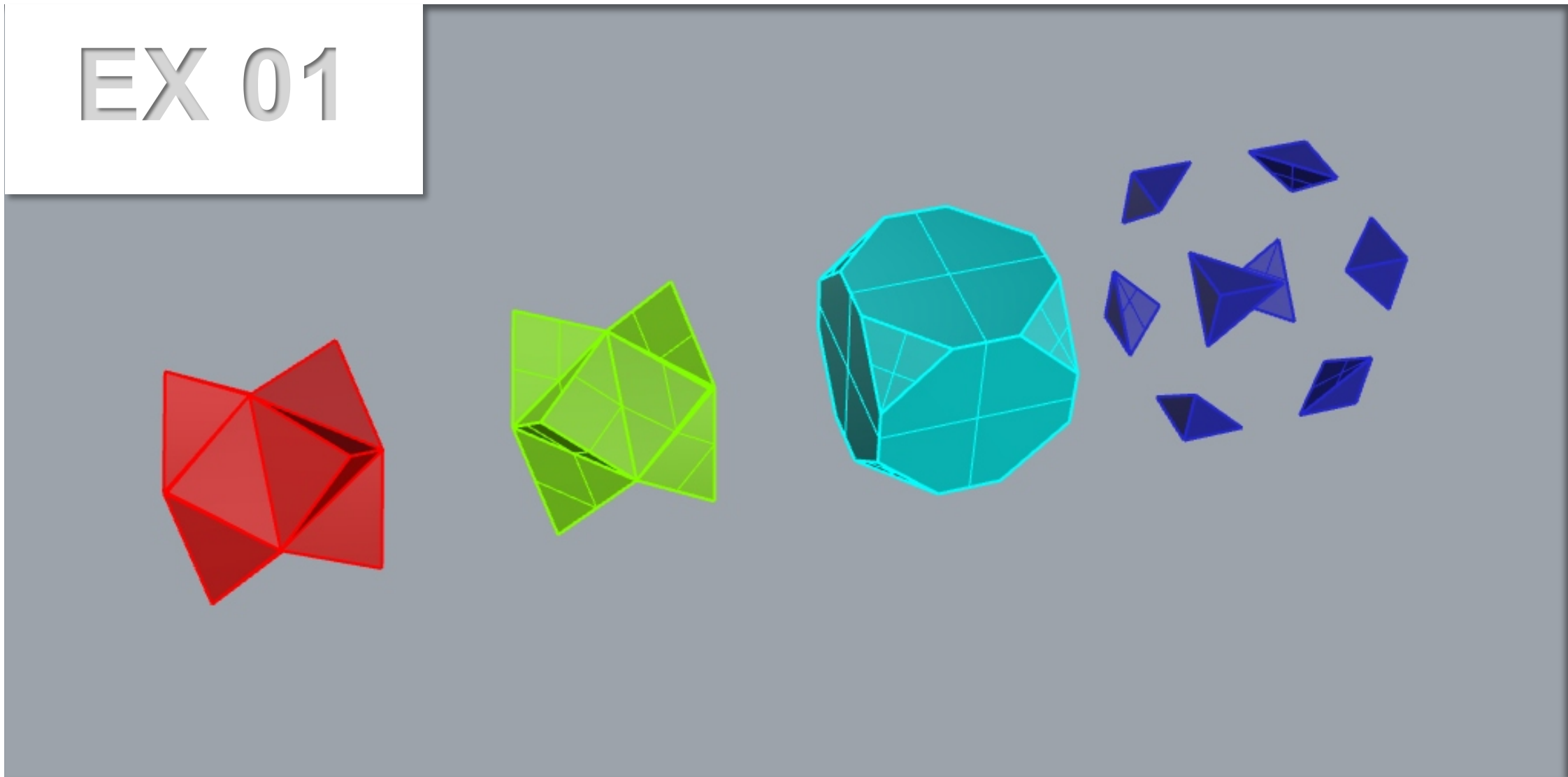

Exercício 1.0 - POLIEDROS

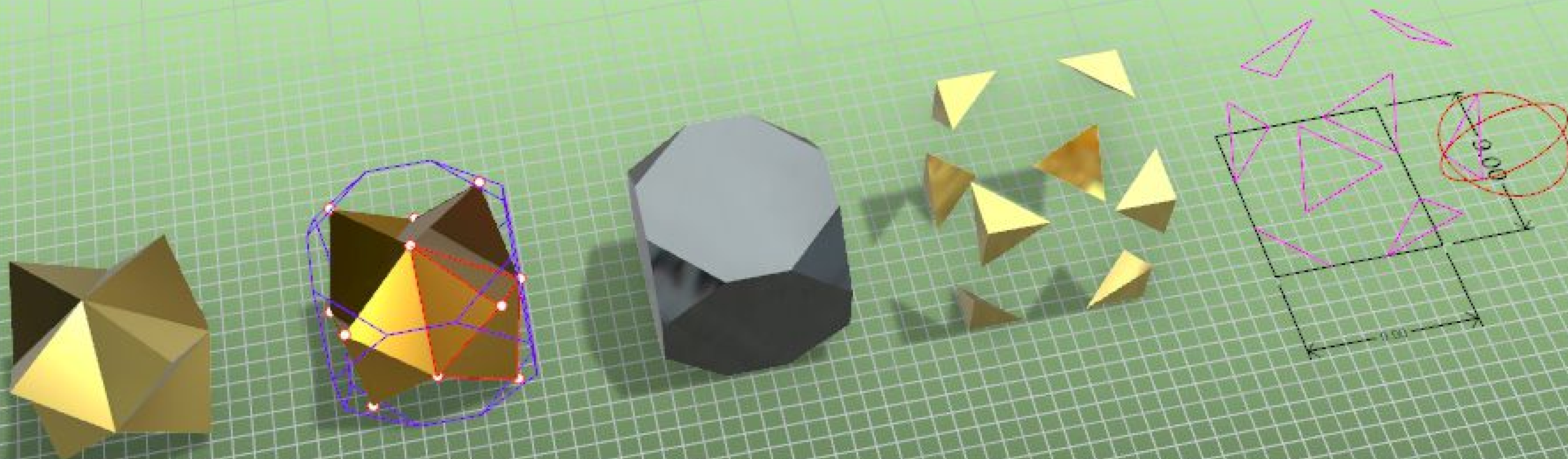

Exercício 1.1 - Dual de Cubo truncado a $\frac{1}{3}$ da aresta

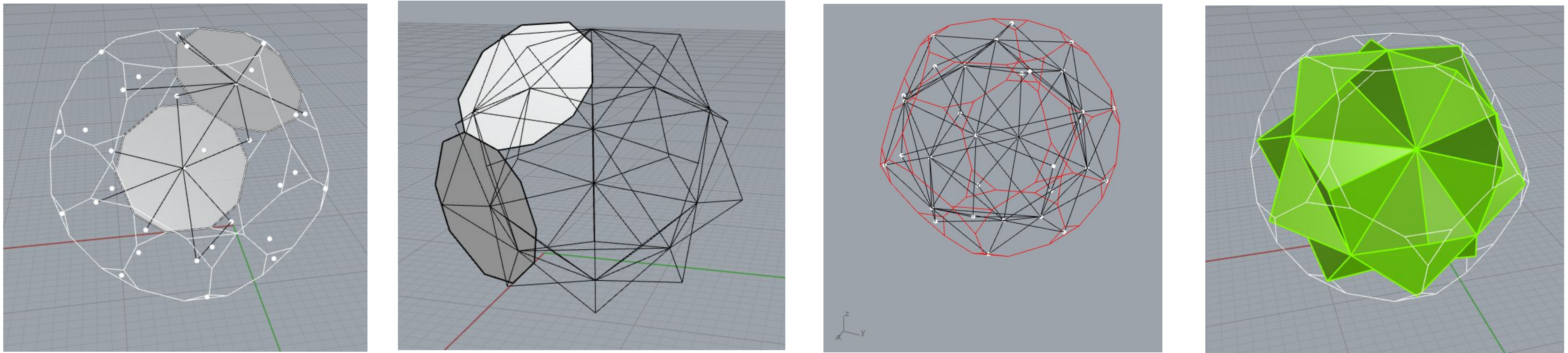
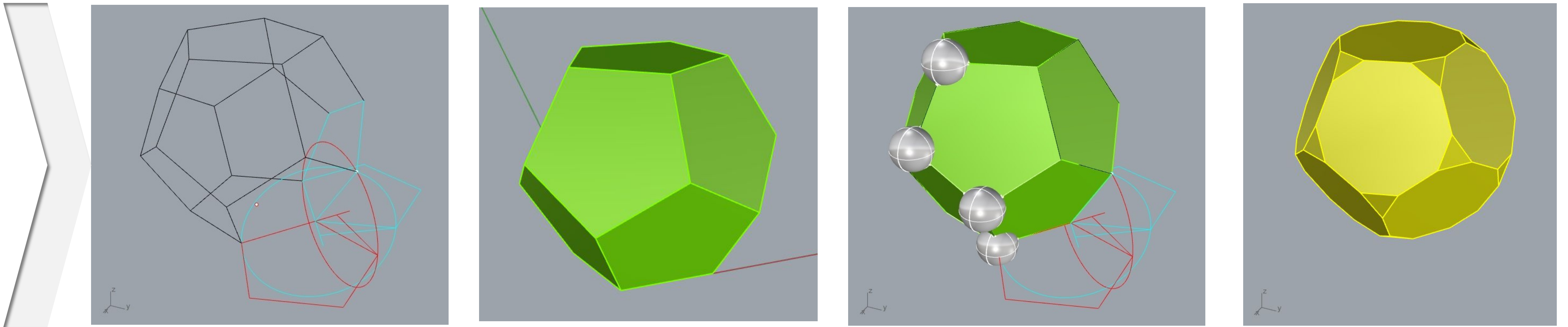

Exercício 1.2 - Dual de Dodecaedro truncado a $\frac{1}{4}$ da aresta

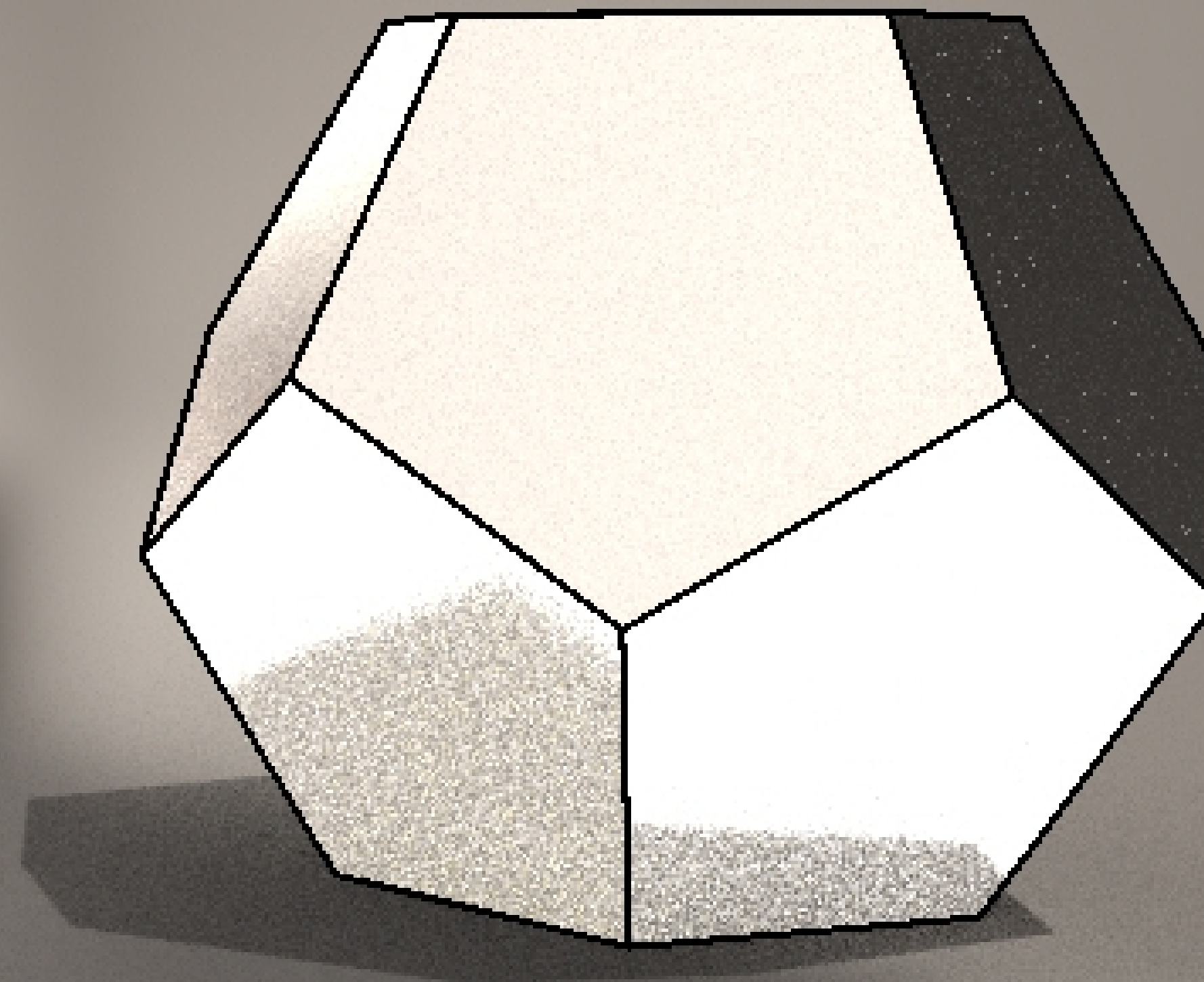
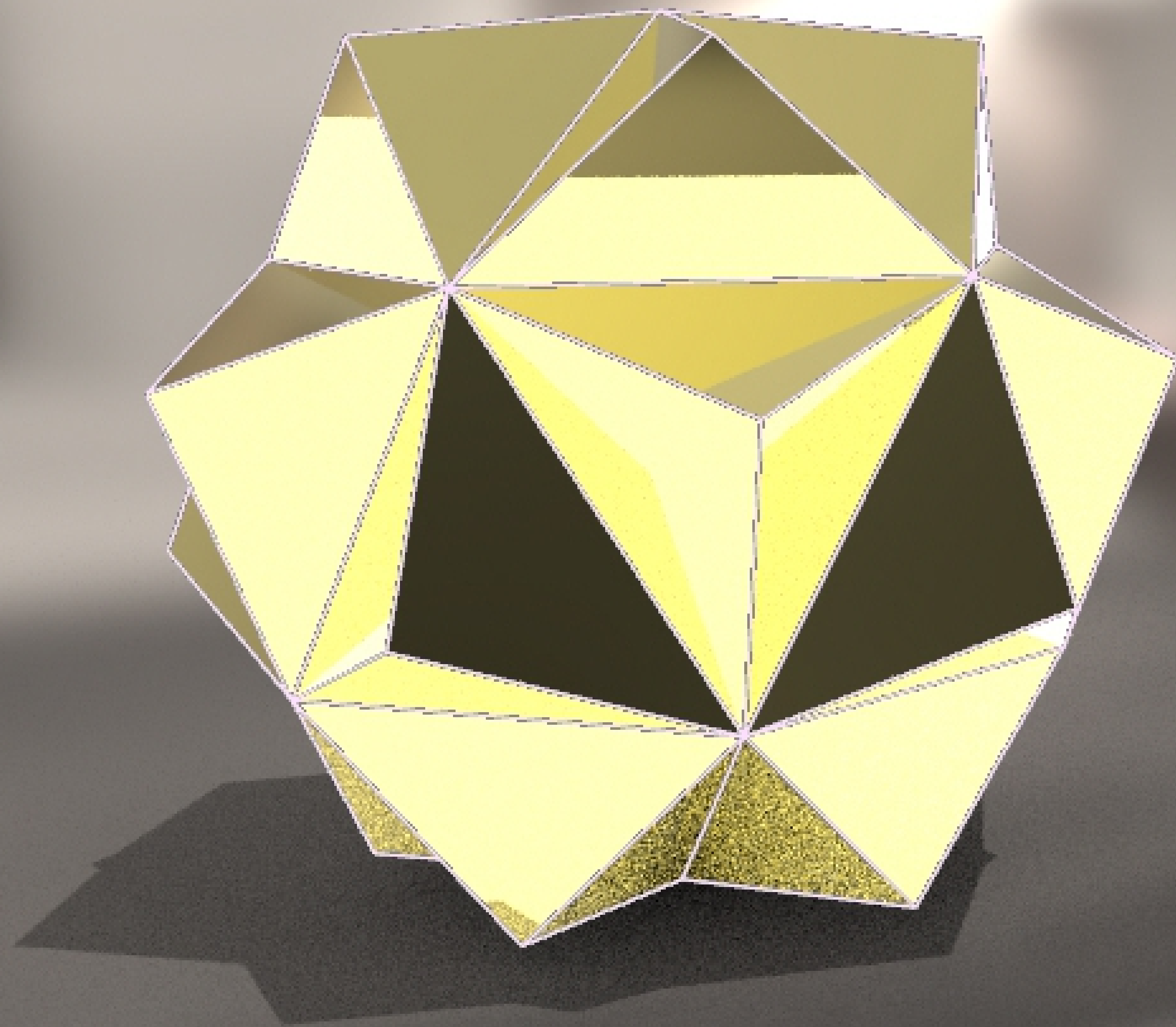

Exercício 1.2 - Dual de Dodecaedro truncado a $\frac{1}{4}$ da aresta

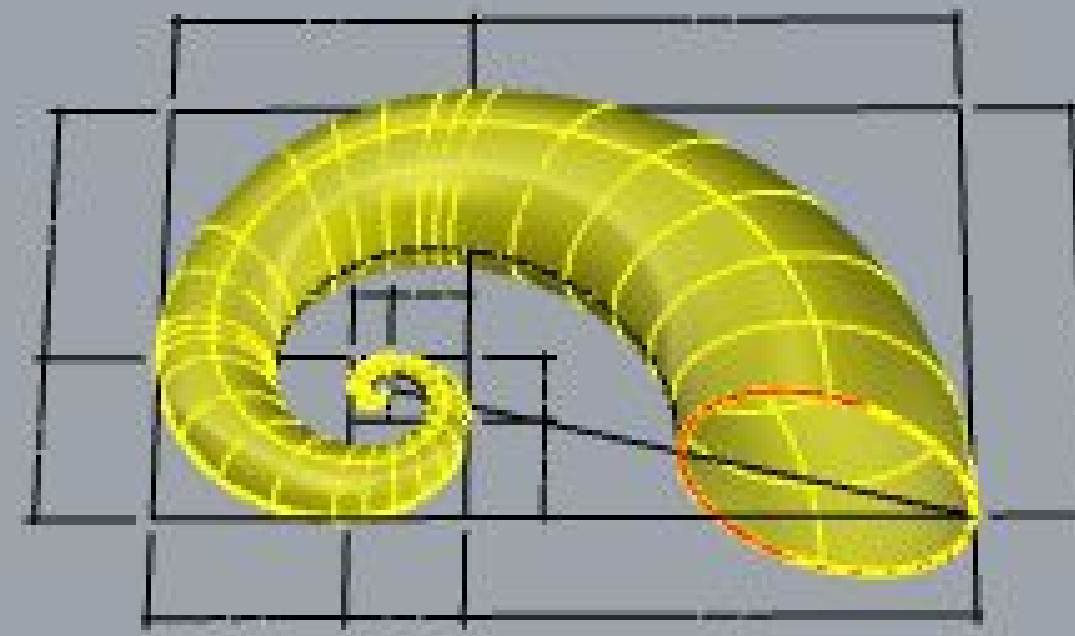

2.1 SERPENTINA / SPIRULA

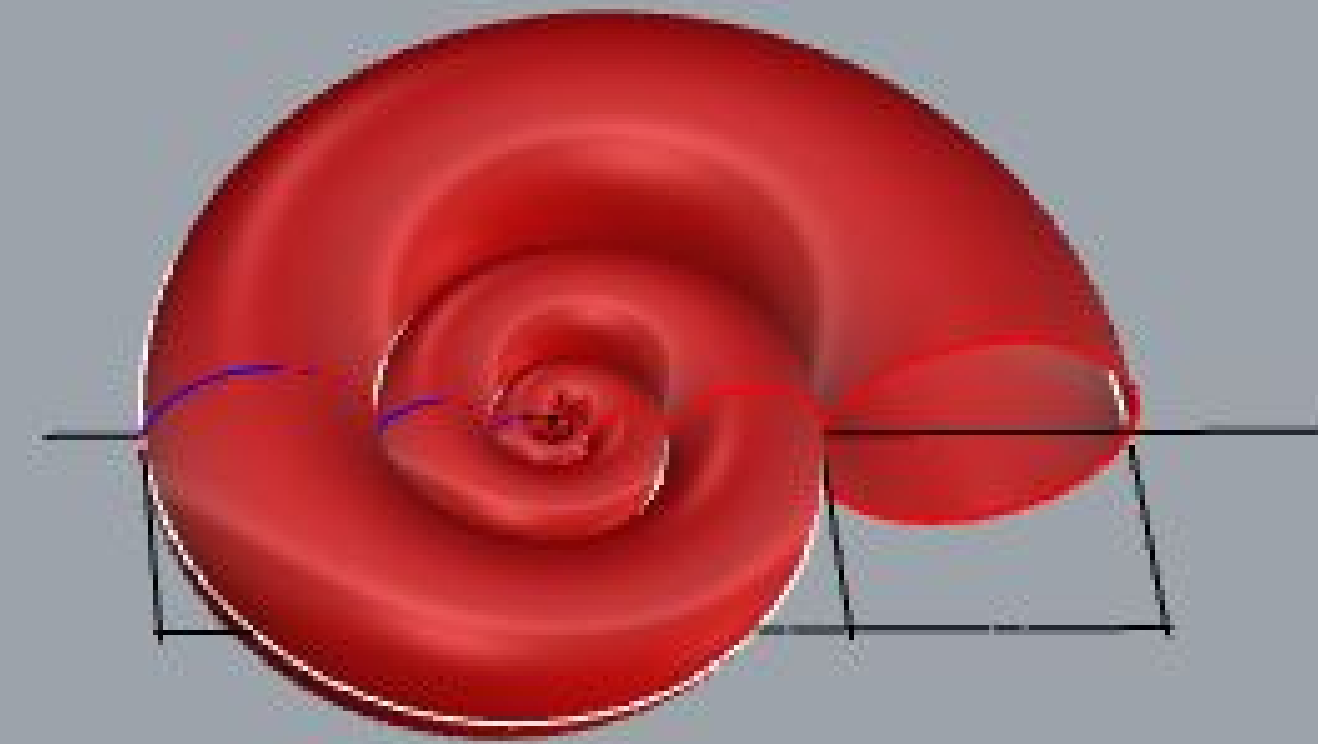

2.2 PLANORBIS

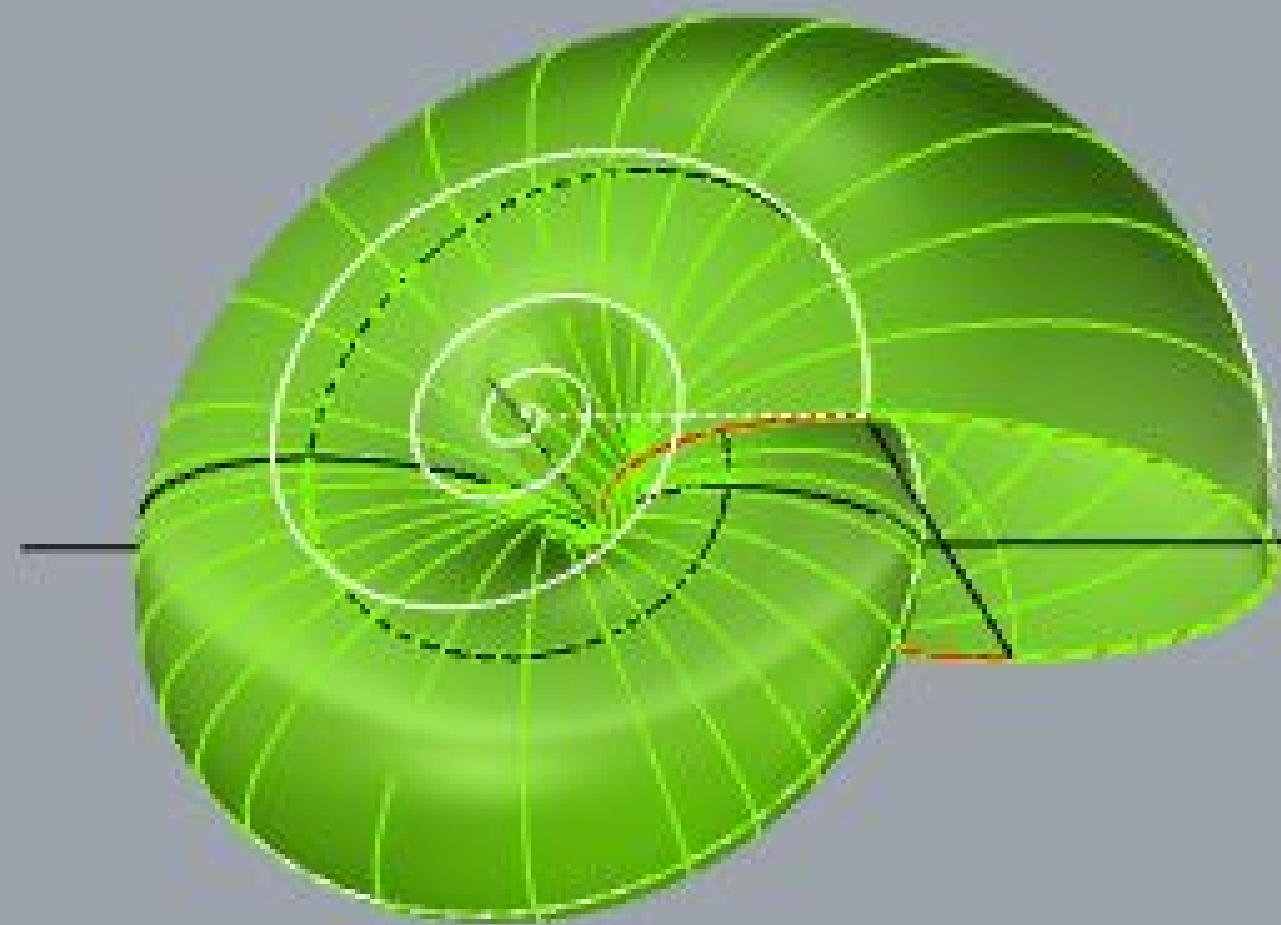

2.3 NAUTILUS

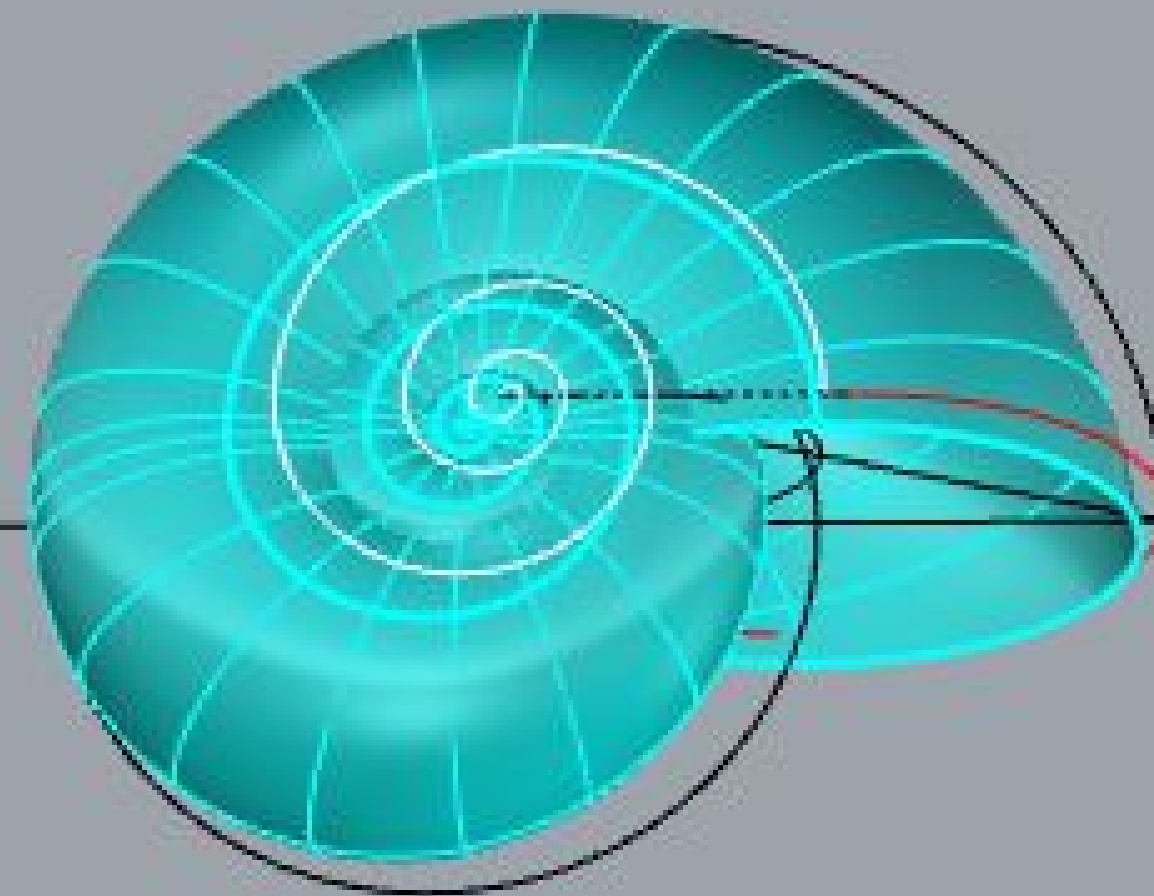

2.4 CARACOL

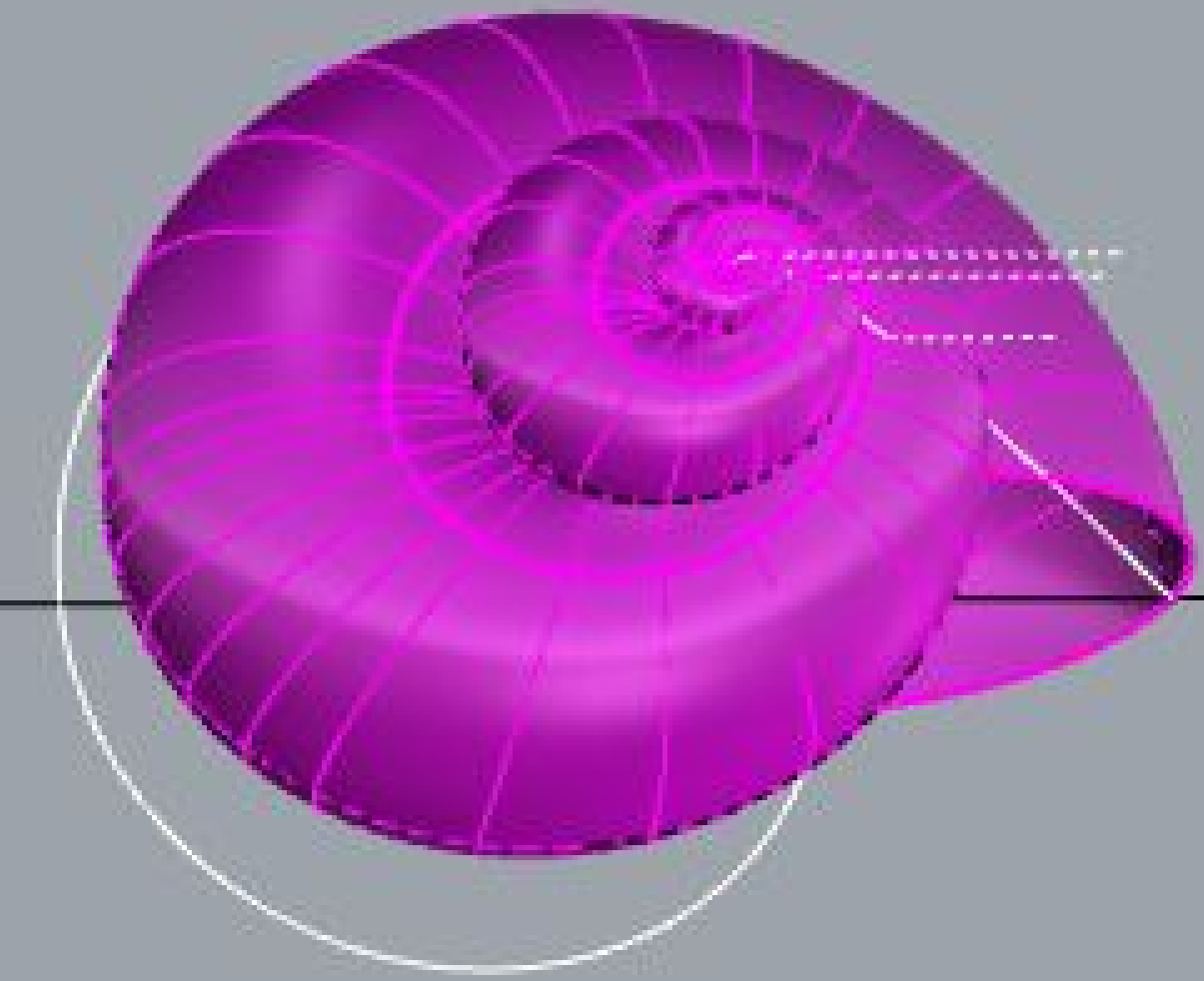

2.4 CARAMUJO DO MAR

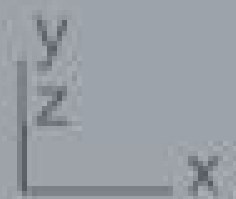

Exercício. 2.0 - Moluscos

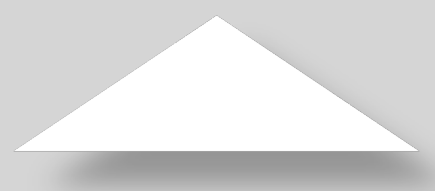

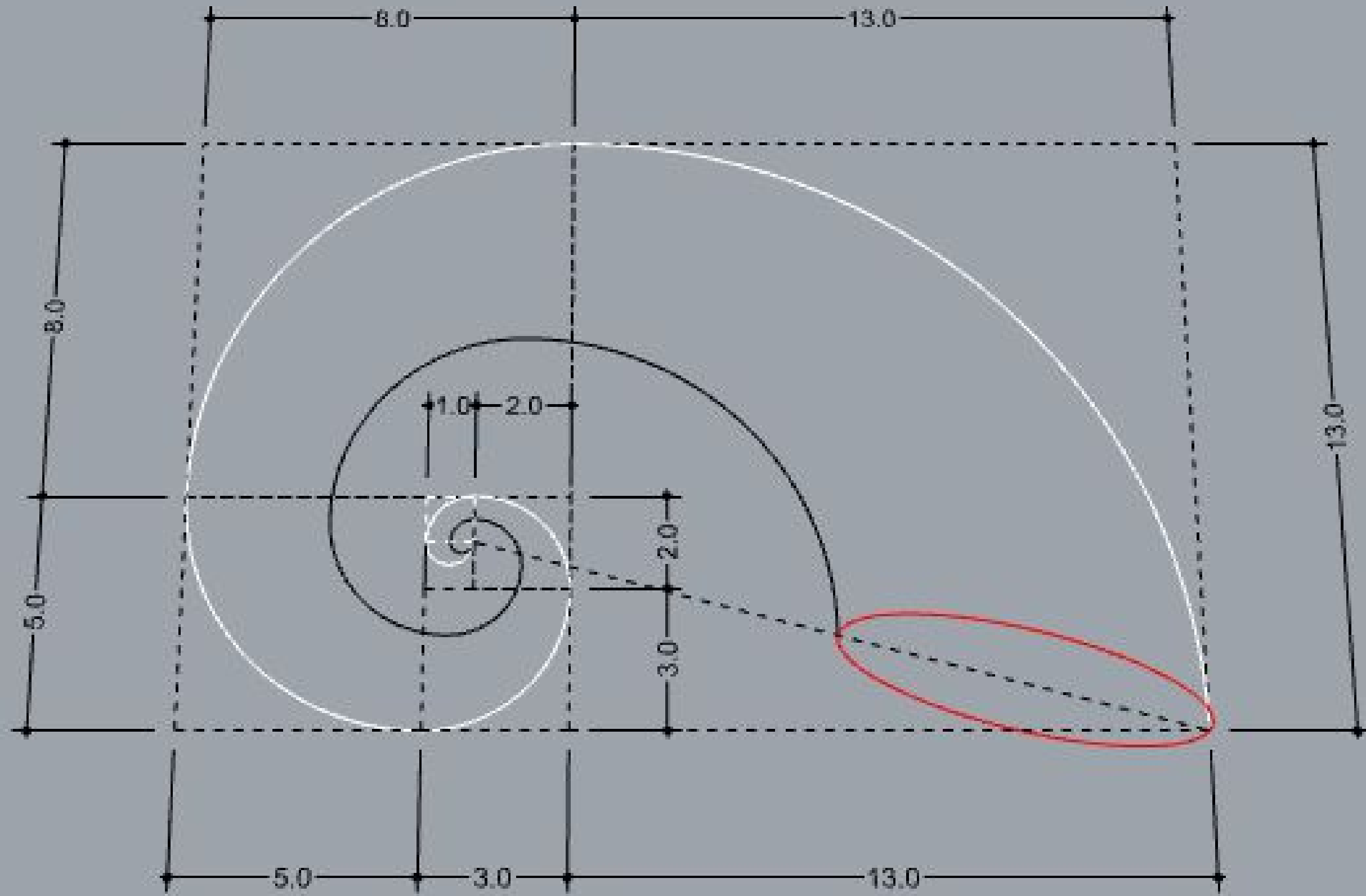

2.1 SERPENTINA / SPIRULA

Exercício. 2.1 - Spirula

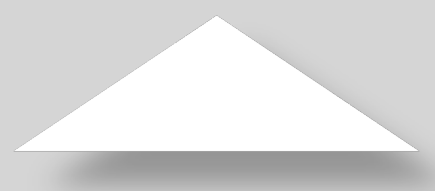

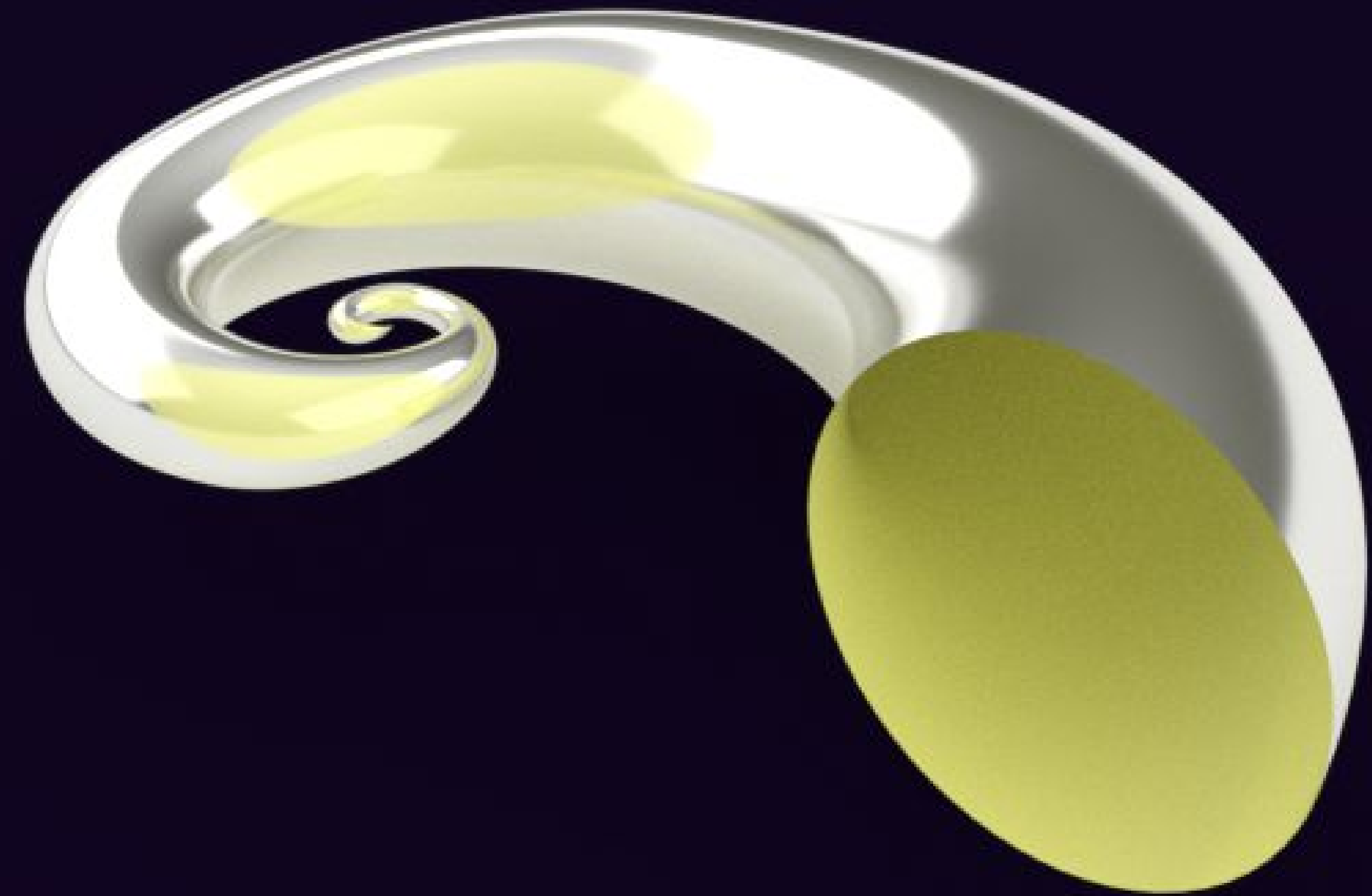
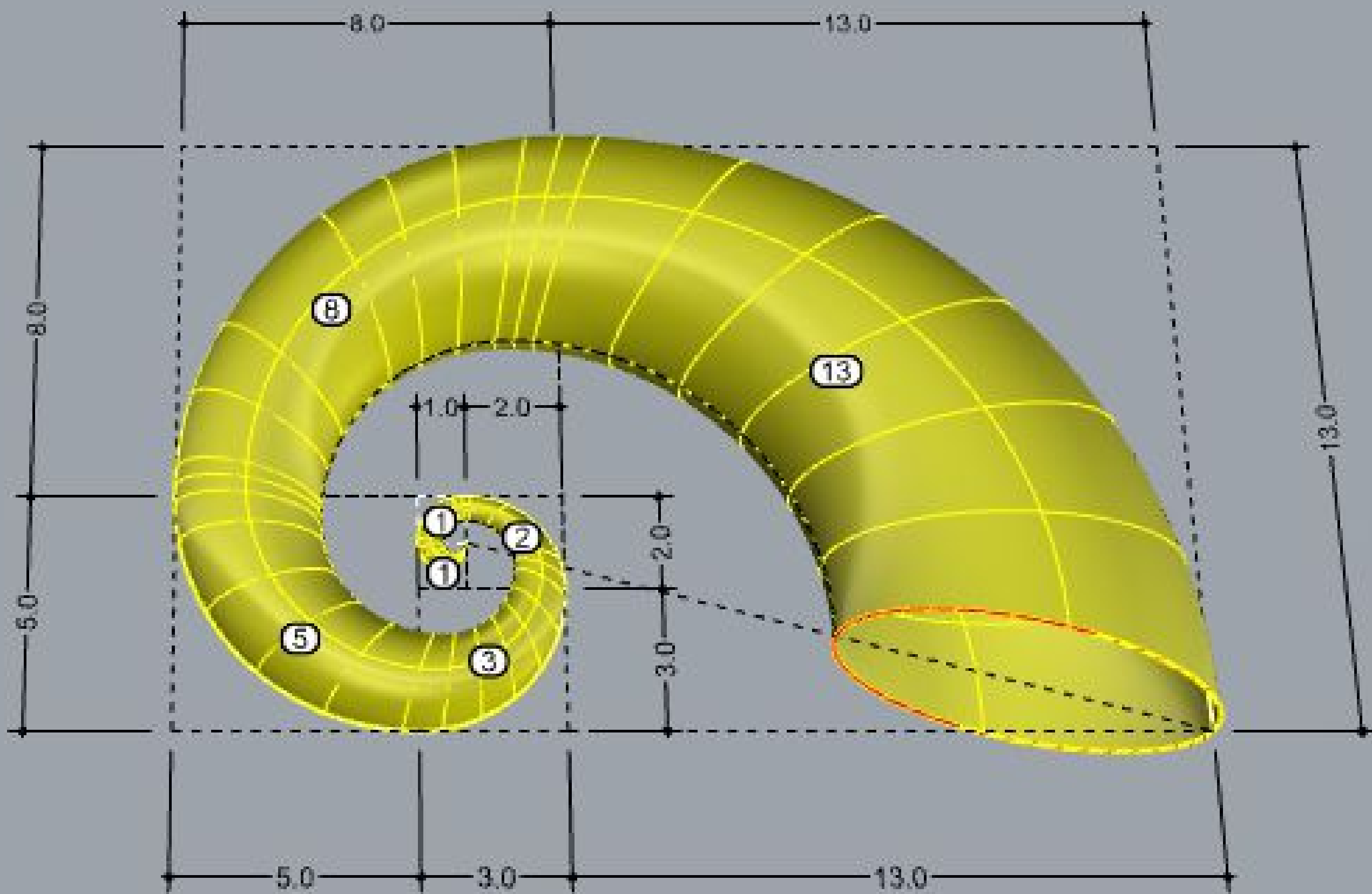

2.1 SERPENTINA / SPIRULA

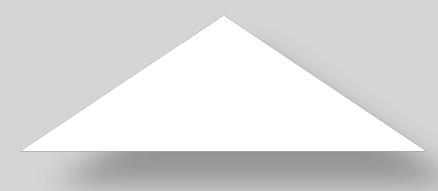

Exercício. 2.1 - Spirula

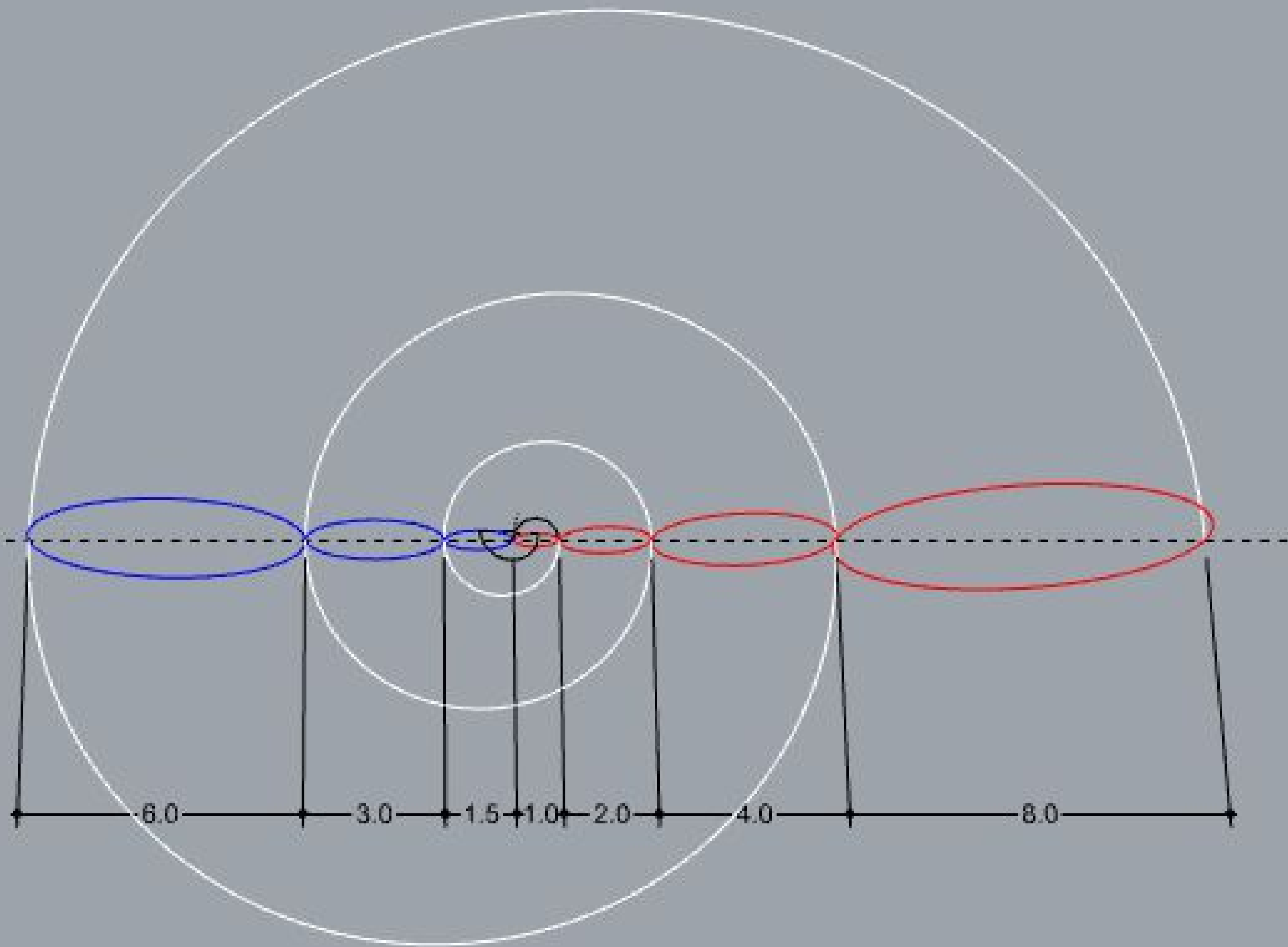

2.2 PLANORBIS



Exercício 2.2 - Planorbis

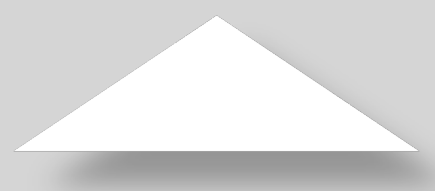

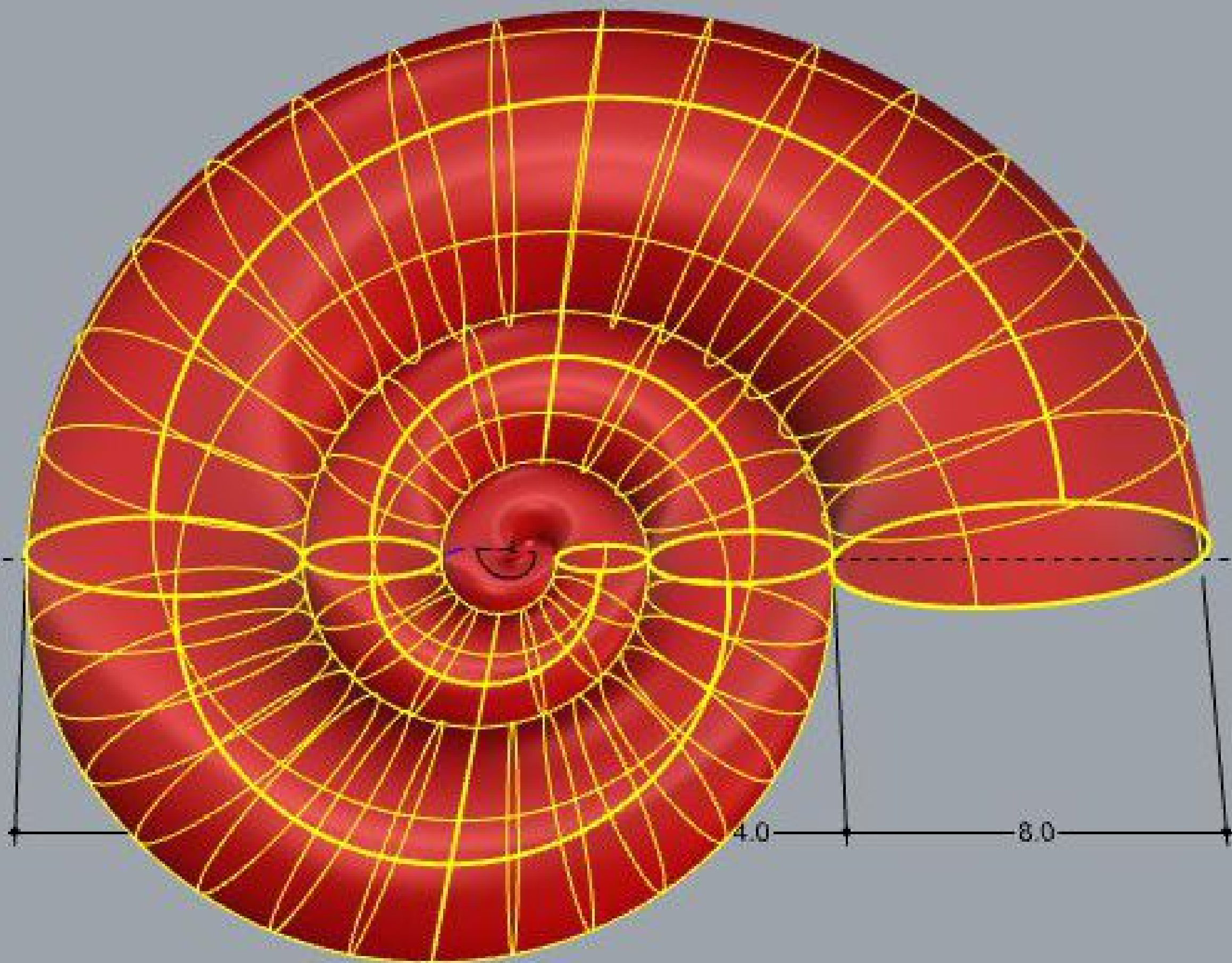

2.2 PLANORBIS

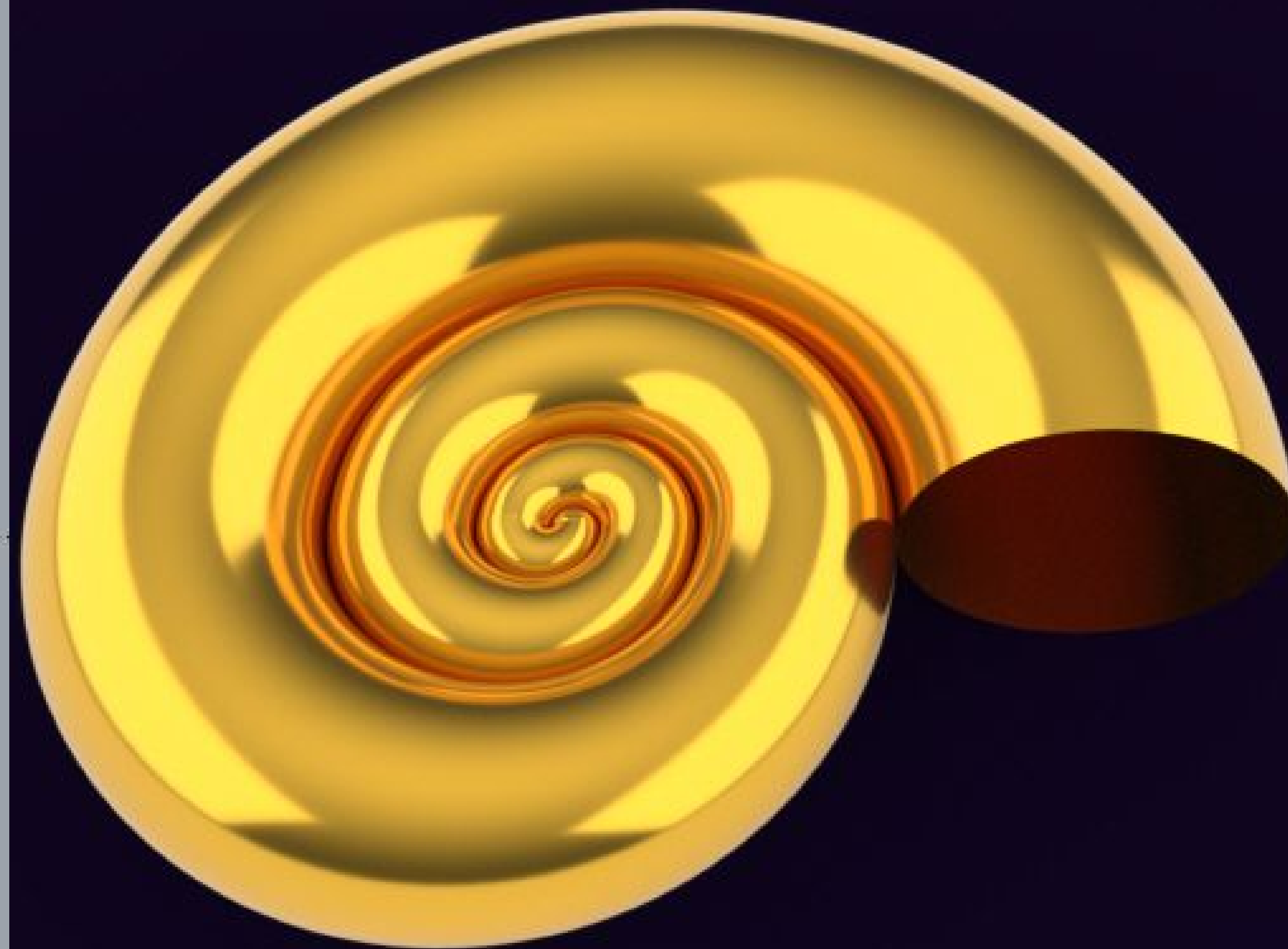

Exercício 2.2 - Planorbis



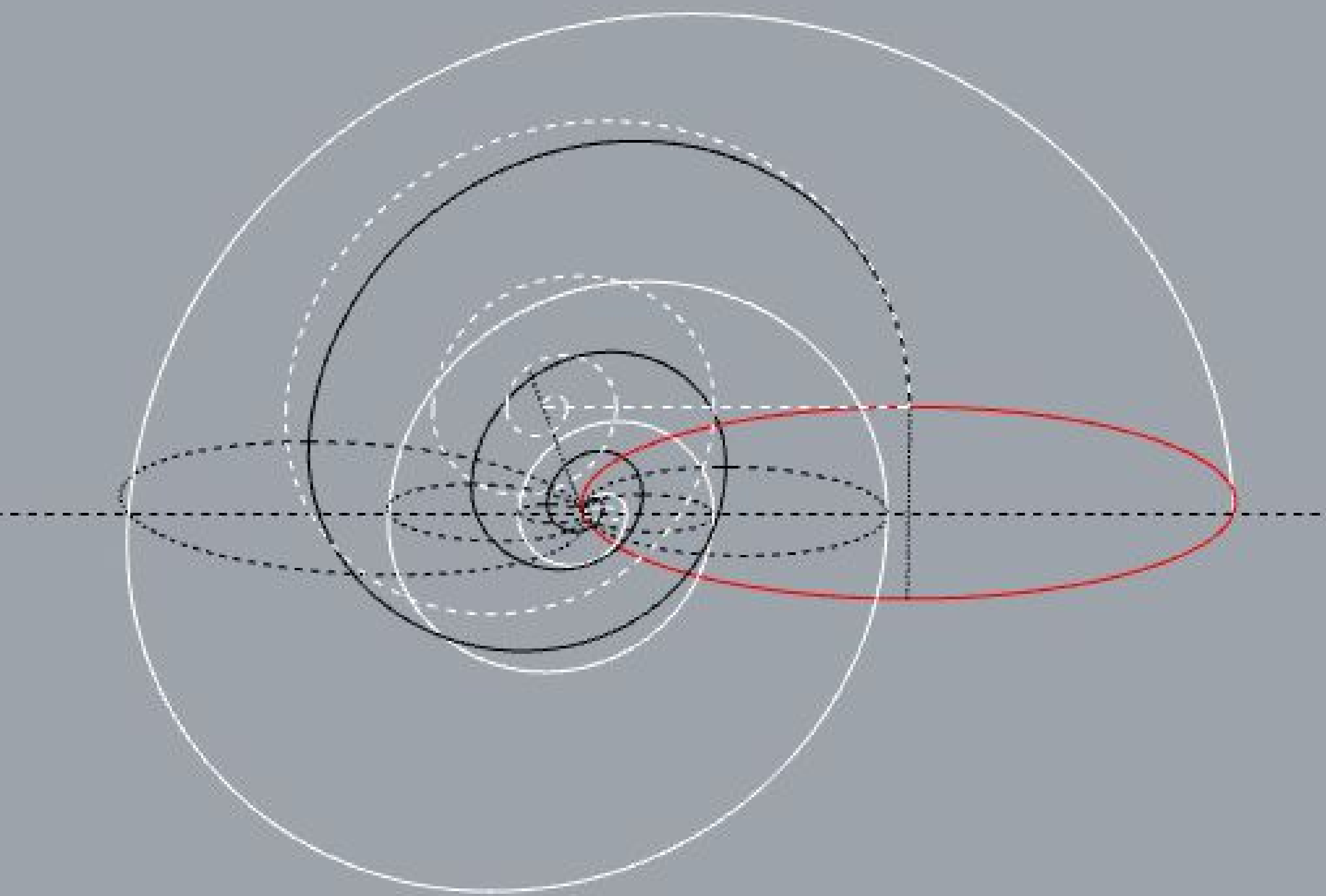

2.3 NAUTILUS



Exercício 2.3 - Nautilus



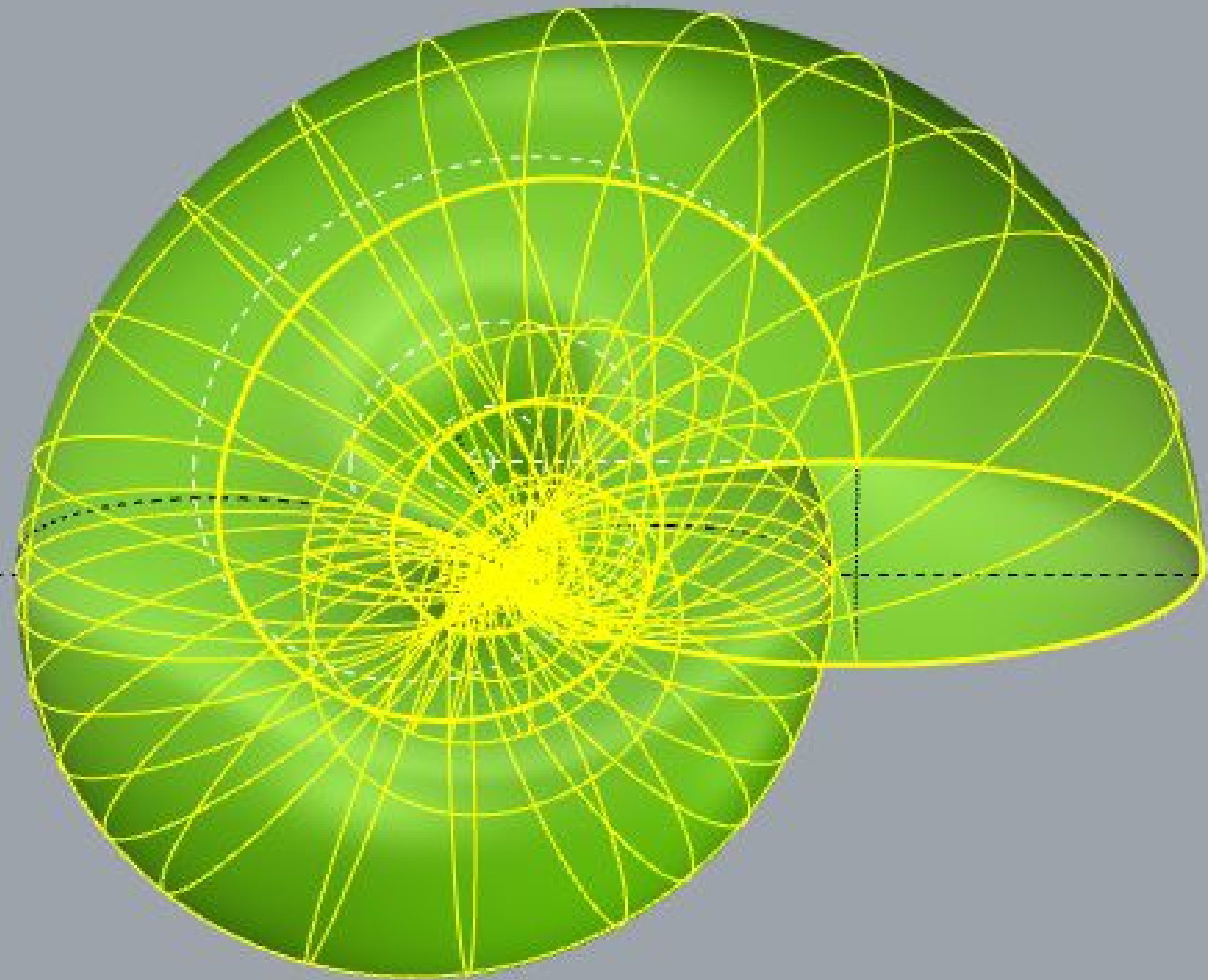

2.3 NAUTILUS

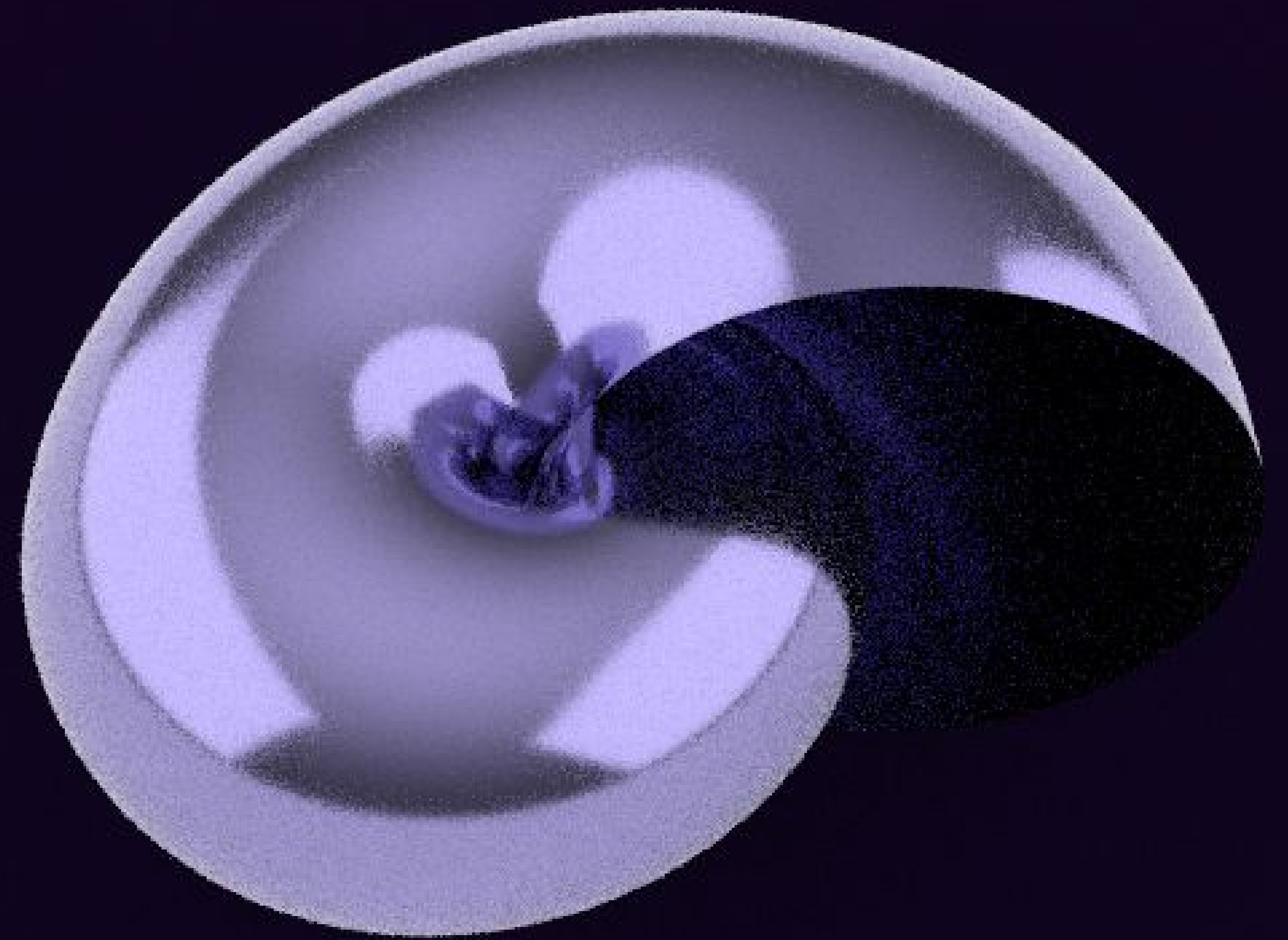

Exercício 2.3 - Nautilus

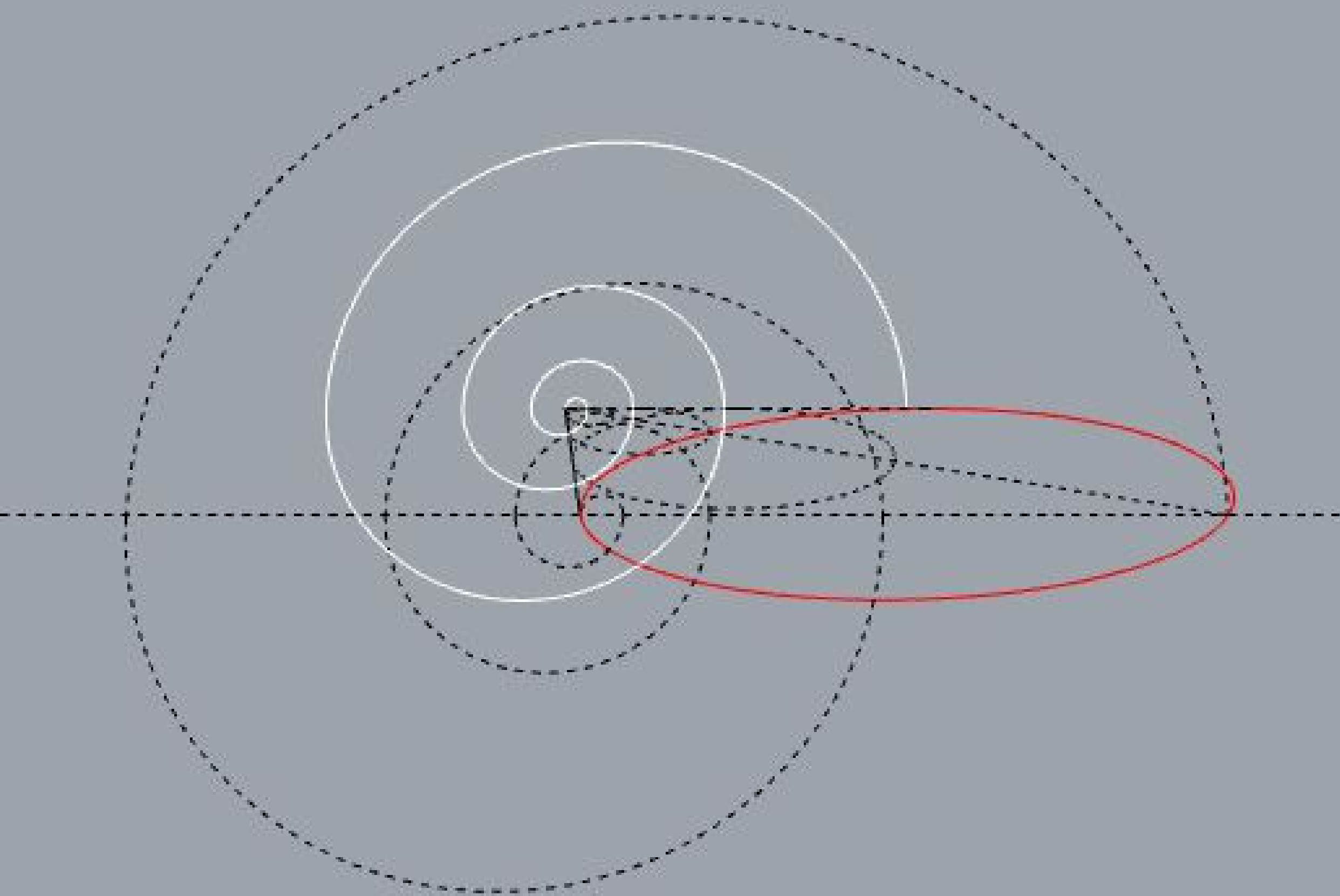

2.4 CARACOL



Exercício 2.4 - Caracol



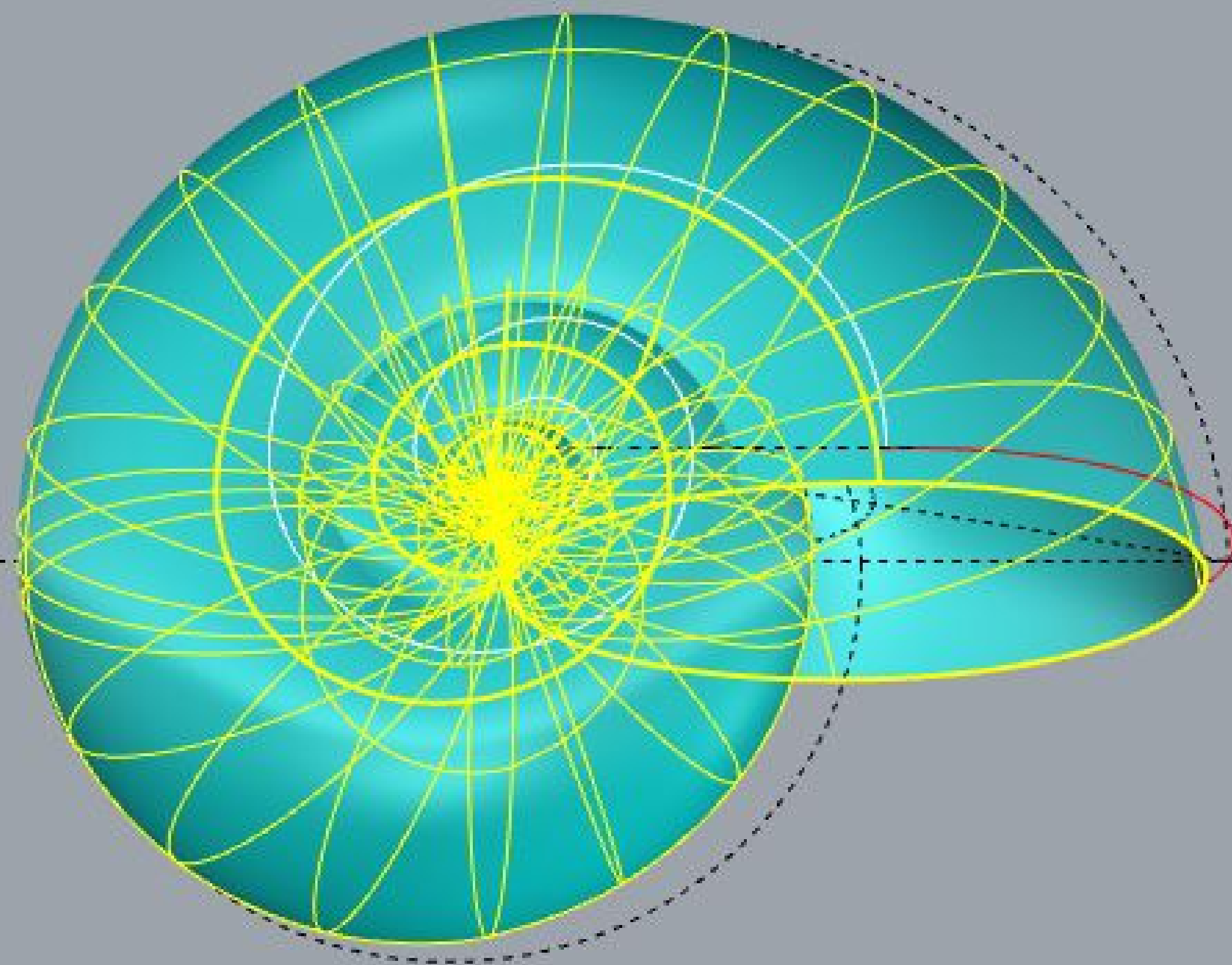

2.4 CARACOL

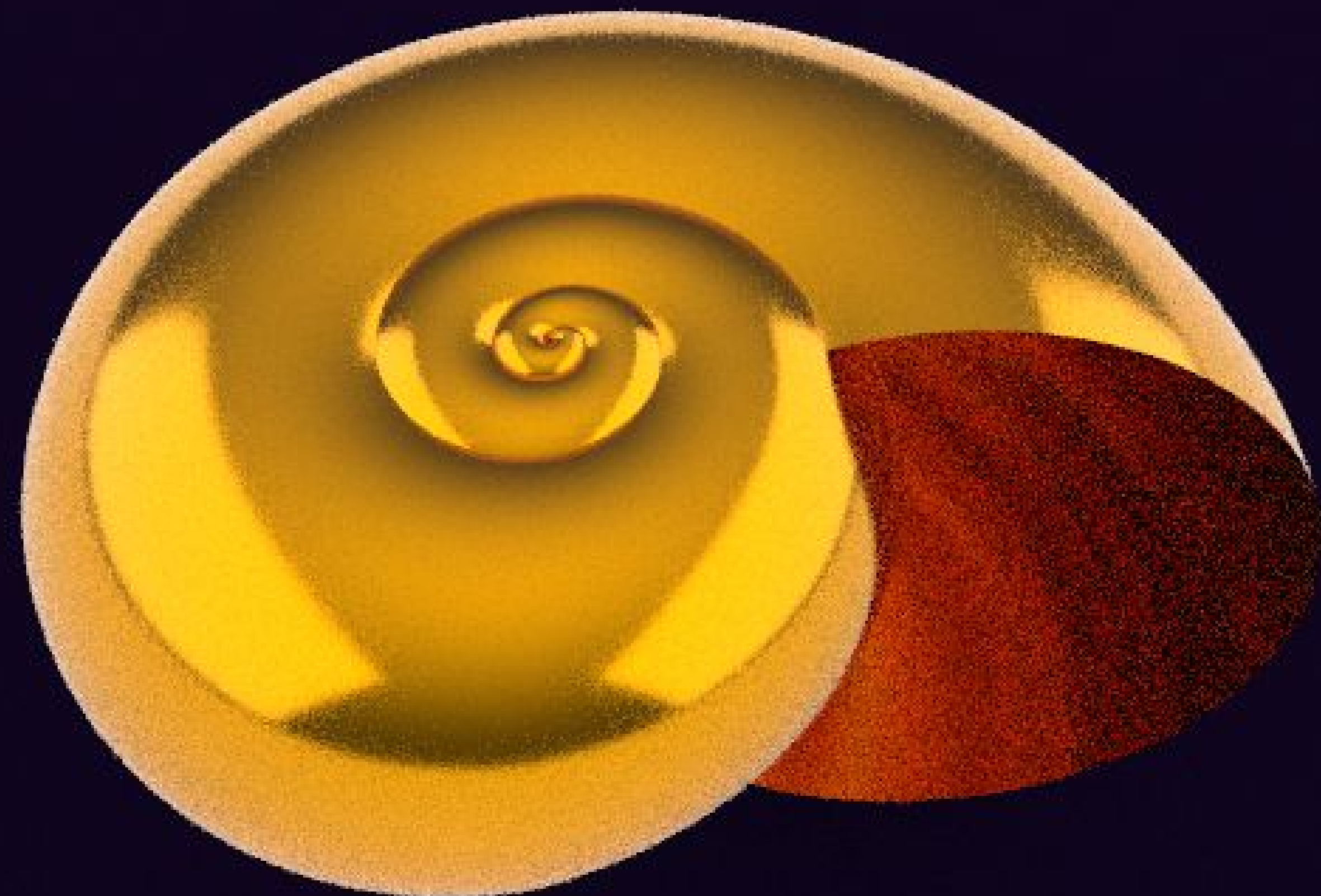

Exercício 2.4 - Caracol



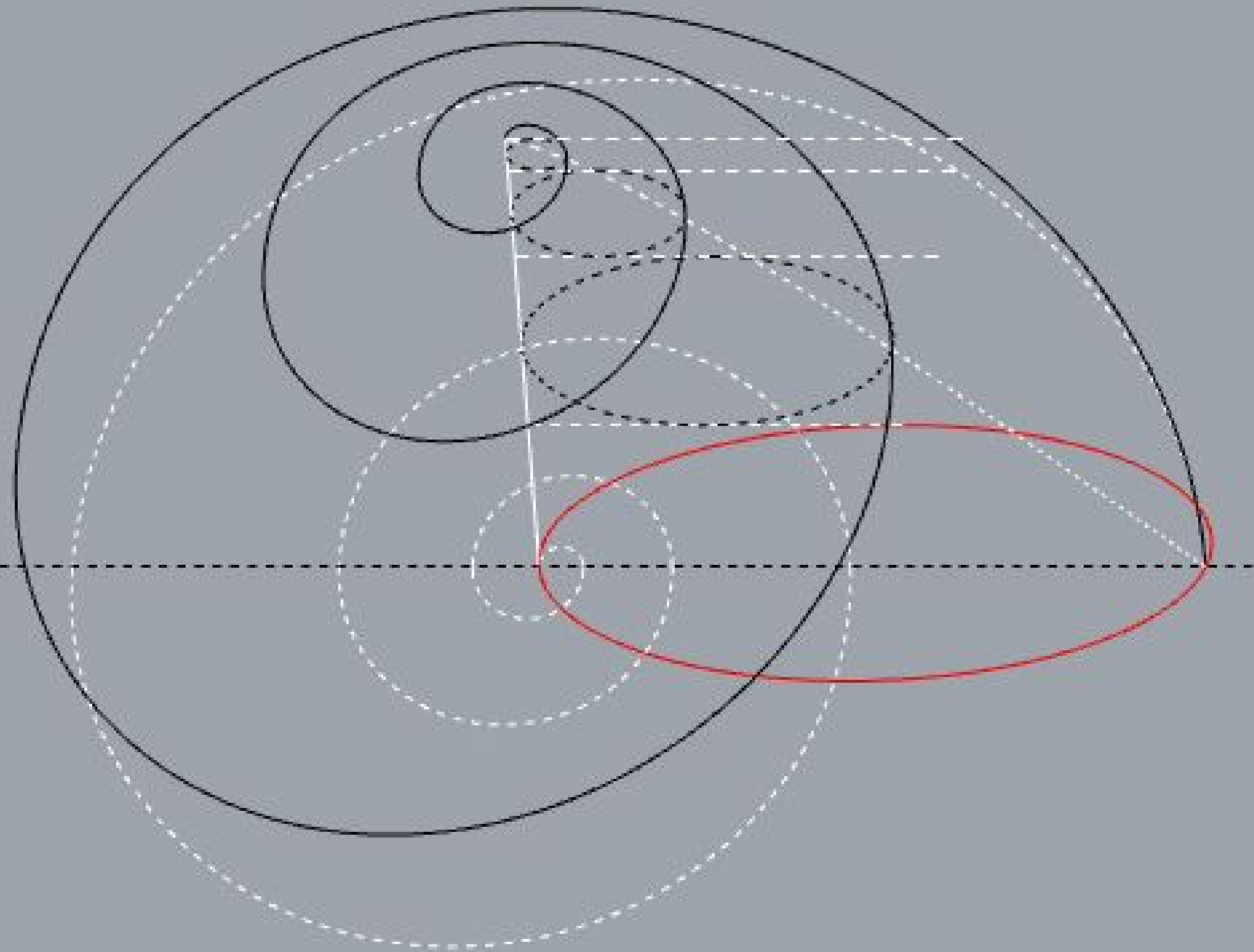

2.5 CARAMUJO DO MAR



Exercício 2.5 – Caramujo do Mar

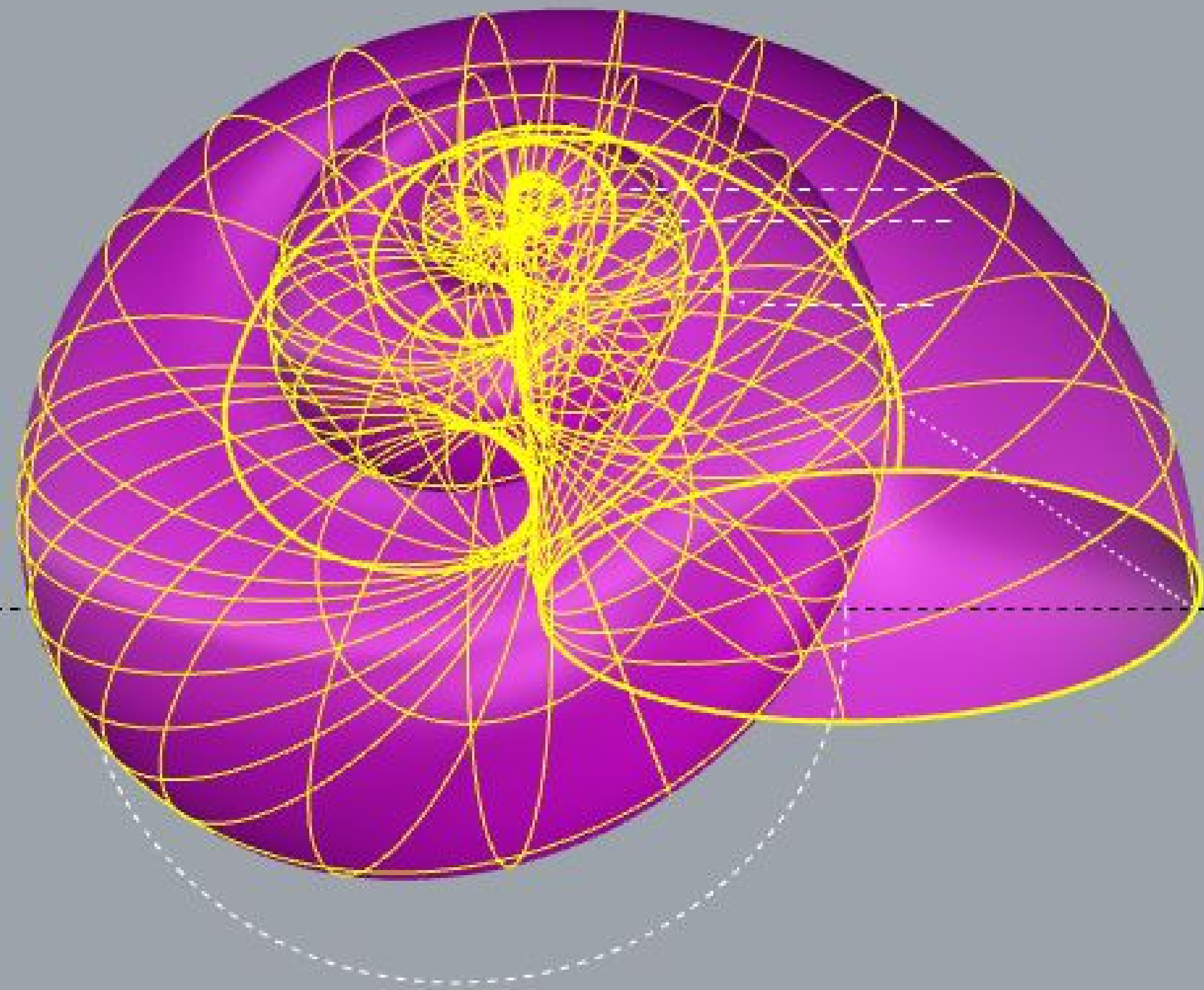

2.5 CARAMUJO DO MAR

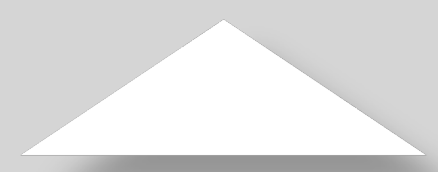

Exercício 2.5 – Caramujo do Mar