

# Representação Digital

# 2023-2024

20221292

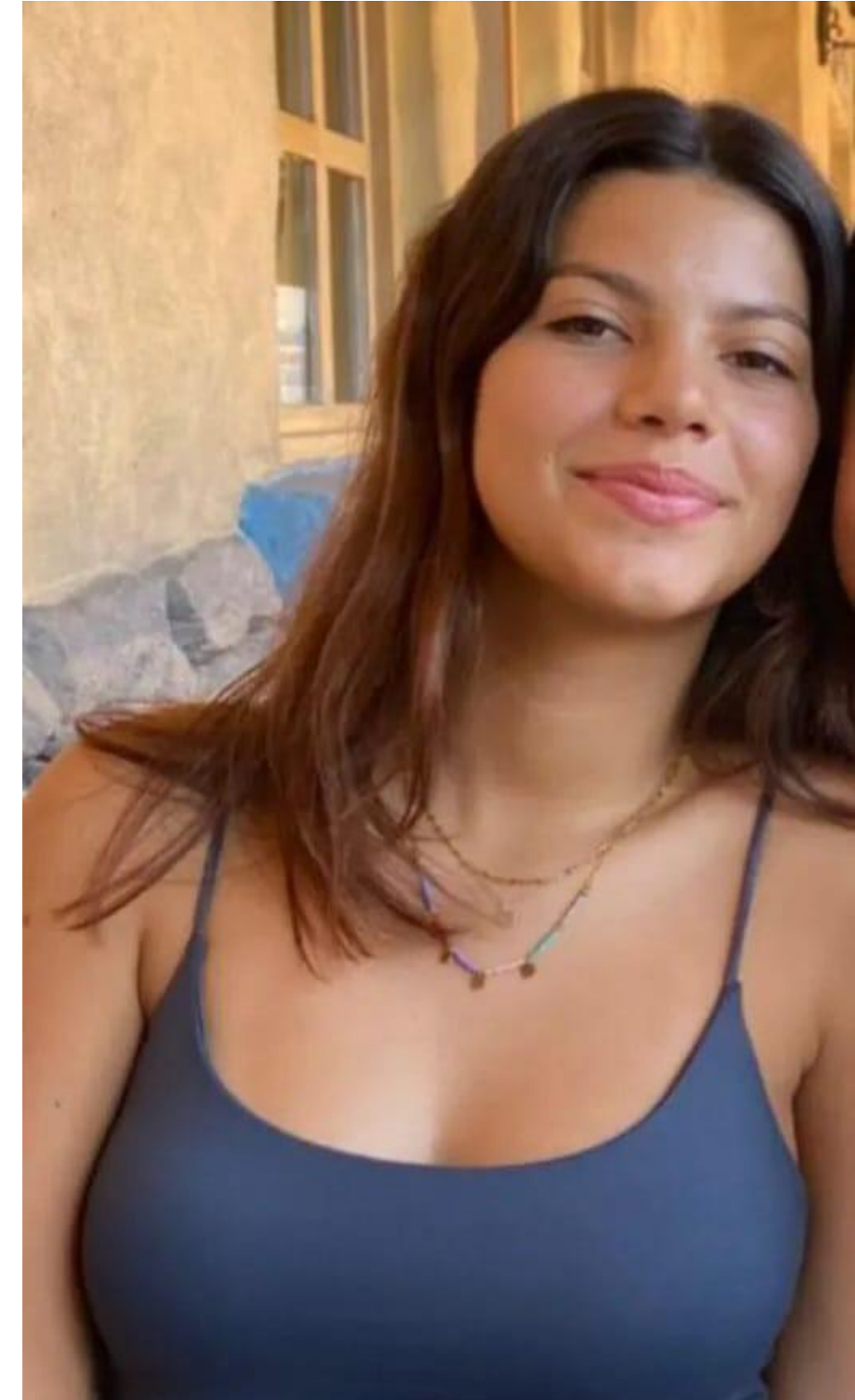

Matilde Sanches da Fonseca Nunes

# ÍNDICE

## Sumários

Semana 1 (19 e 22 de setembro) .....	slides 4 e 5
Semana 2 (26 e 29 de setembro) .....	slides 6 a 9
Semana 3 (3 de outubro) .....	slide 10
Semana 4 (10 e 13 de outubro) .....	slide 12
Semana 5 (17 e 20 de outubro) .....	slide 13
Semana 6 (24 e 27 de outubro) .....	slides 14 e 15
Semana 7 (31 de outubro e 3 de novembro) .....	slide 16
Semana 8 (7 e 10 de novembro) .....	slides 17 a 22
Semana 9 (14 e 17 de novembro) .....	slides 23 a 25
Semana 10 (21 e 24 de novembro) .....	slides



# SEMANA 1

 **FACULDADE DE ARQUITETURA**  
UNIVERSIDADE DE LISBOA

[Faculdade de Arquitetura - ULisboa](#)

2023/2024  
Nuno Alão

## Matilde Nunes

20221292

ARQ 2º Ano  
Turma E

### Entregas

[Trabalho 1 - PDE](#)  
[Trabalho 1 - DWG](#)

### [Diário Gráfico](#)



[Contacto](#)

ReDig

Exerc. Página Web

## SEMANA 2

### Comandos:

**L** – line

**Offset** – distanciar linhas paralelas

**Dist** – distância

**List** – lista das características do objeto

**PL** – polyline

**E** – erase

**La** – layer

**U** – undo

**C** – close

**Dtext** – texto

**M** – move

**Co** – copy

**Ro** – rotate

**Al** – align

**Hatch** – preencher com padrões

**Chprop** – mudar propriedades

**Rotate** – rodar

**Mirror** – refletir

**Trim** – cortar

**Extend** – esticar

**Group** – agrupar

**Ungroup** – desagrupar

**Fillet** – unir linhas

**Tipo de ficheiro:** acadiso.dwg

**Unidades:** mm

### Coordenadas:

- Absolutas (x,y,z) relativas ao ponto (0,0,0)

- Relativas (@) ao ponto anterior

- Polares < ângulo

## SEMANA 2

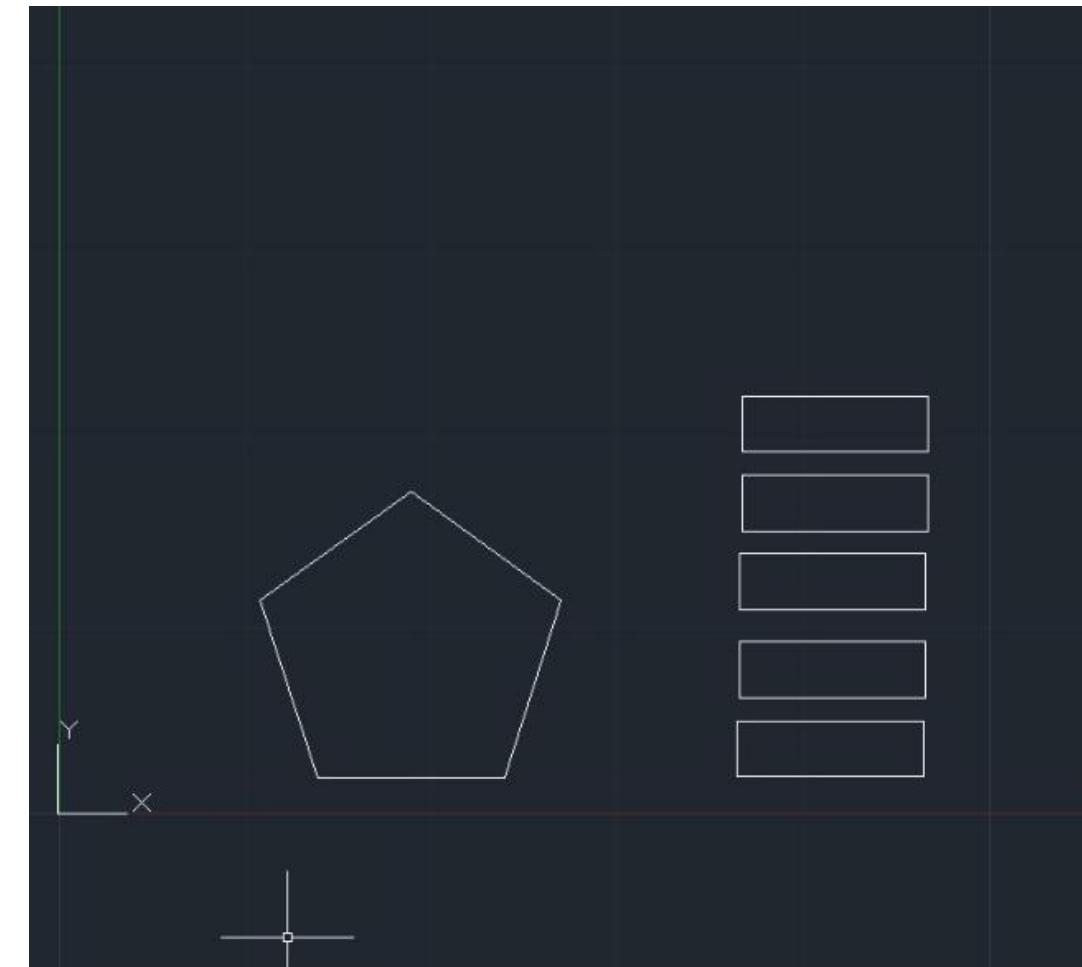
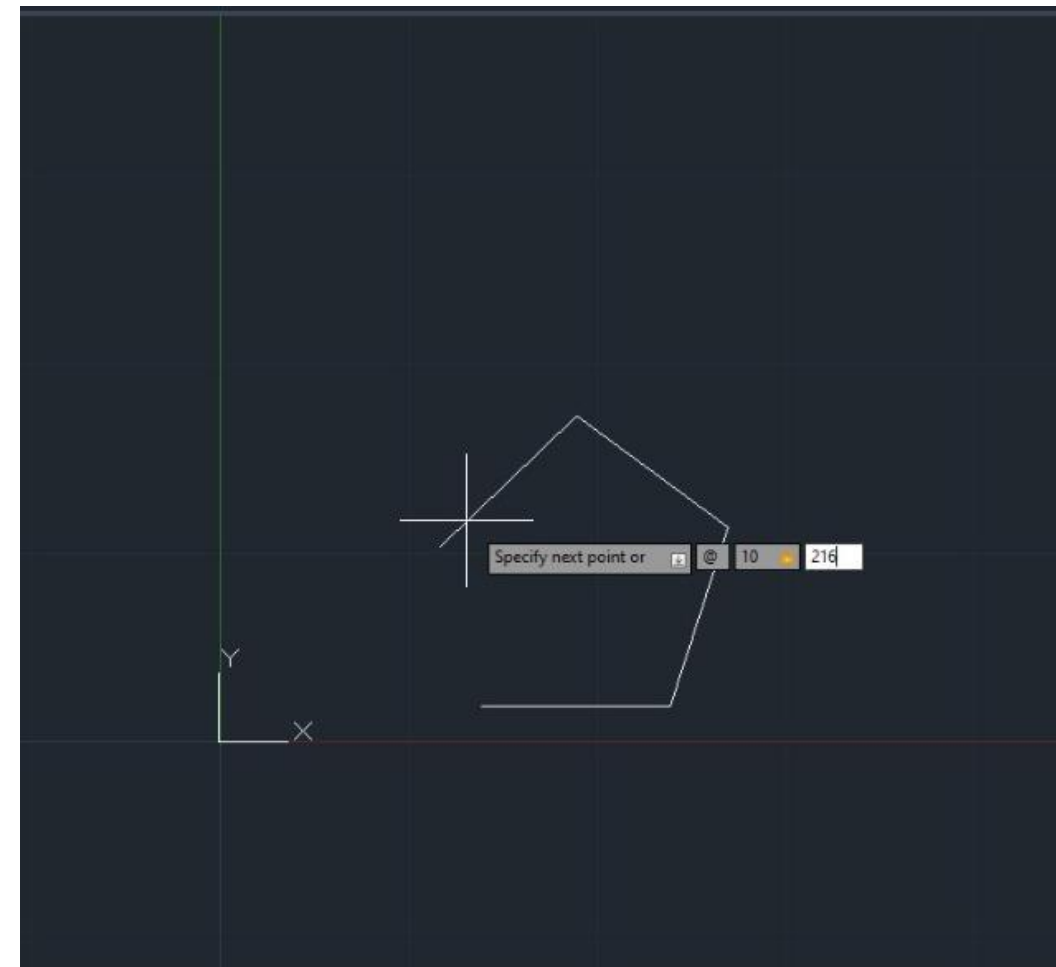
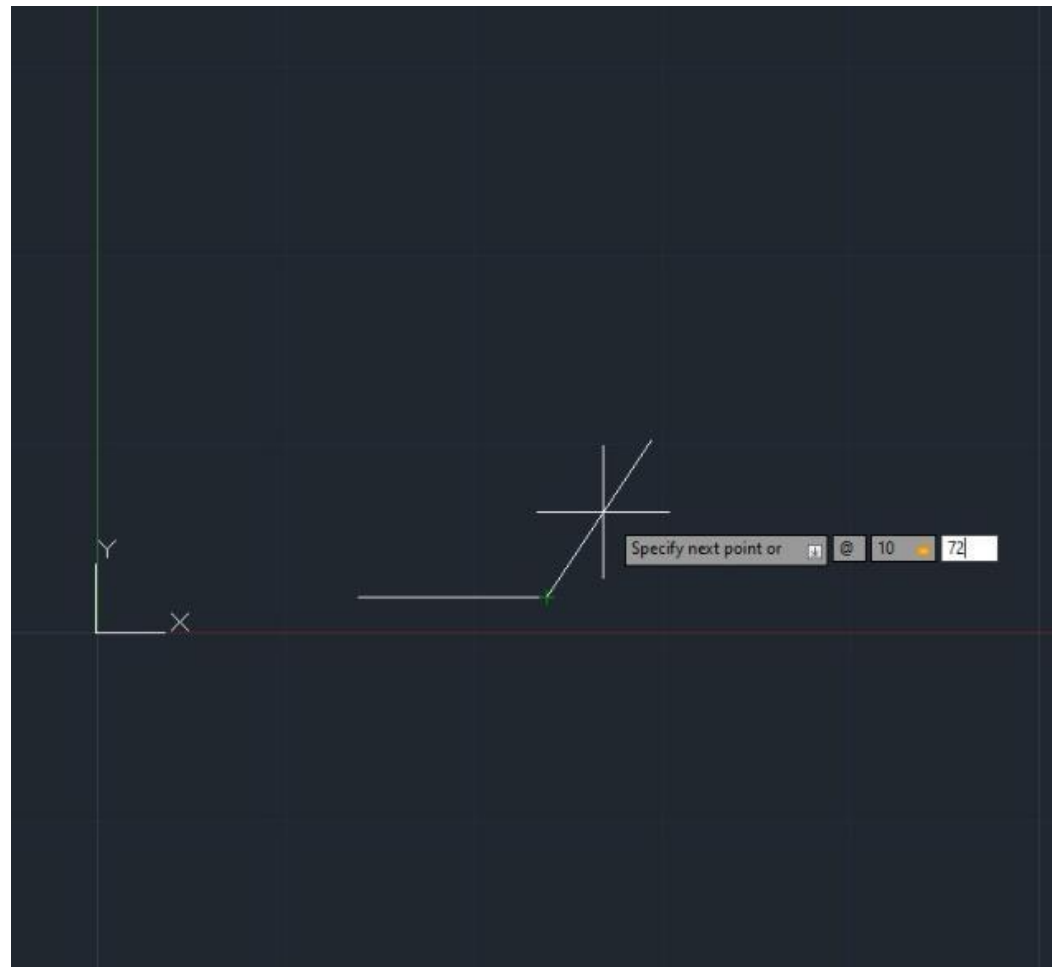

ReDig

Exerc. Intro AutoCAD

# SEMANA 2

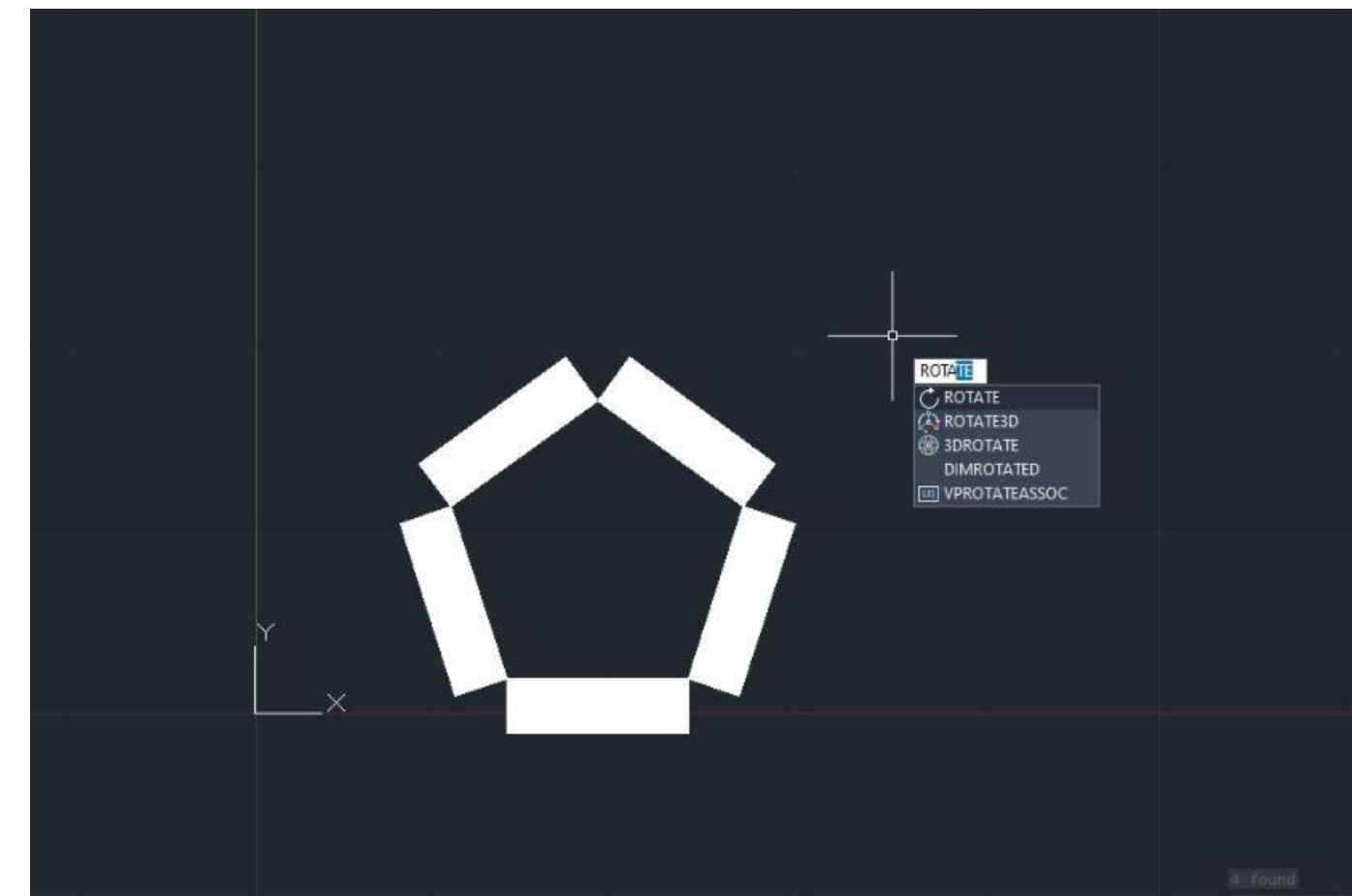
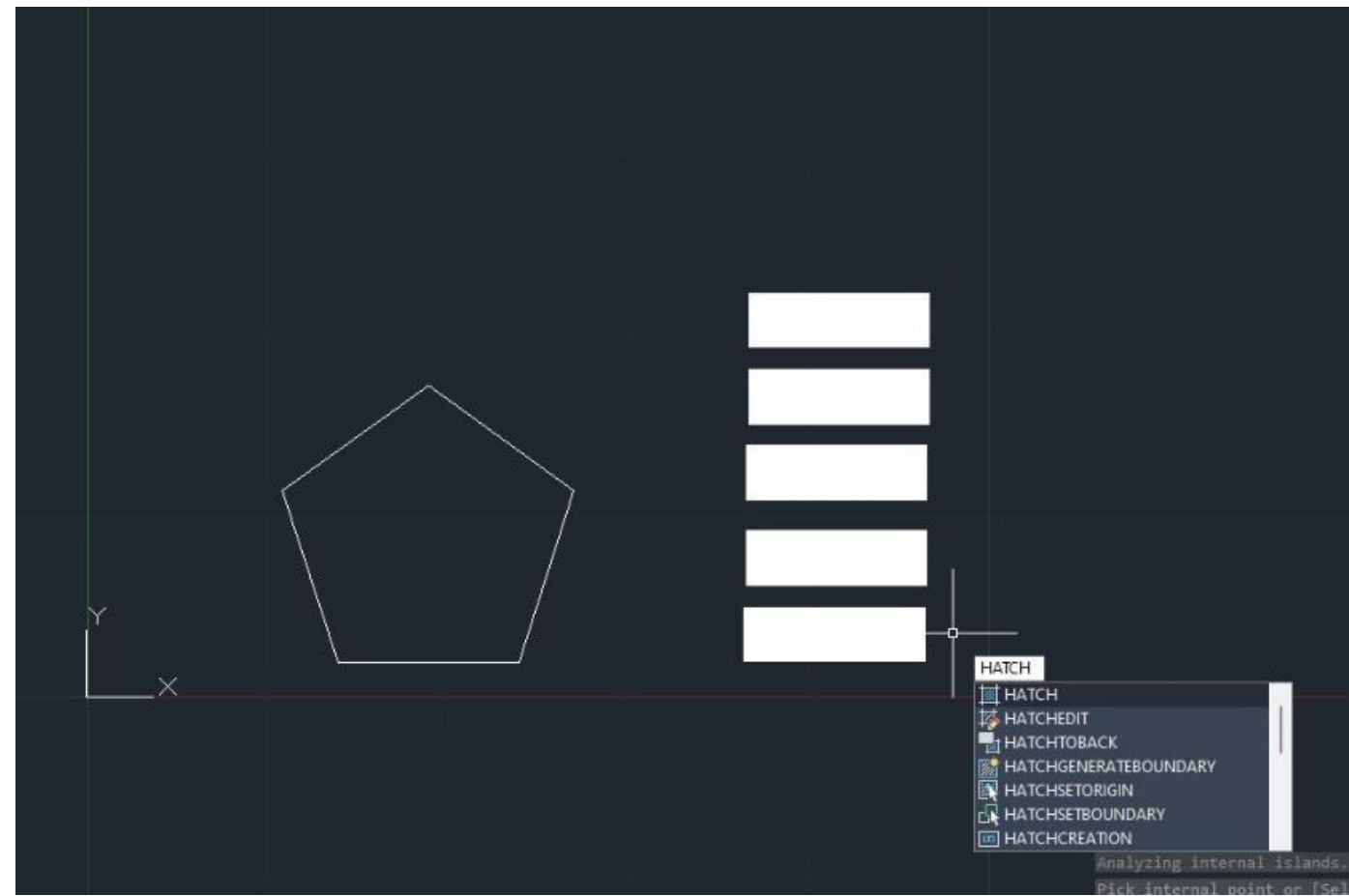
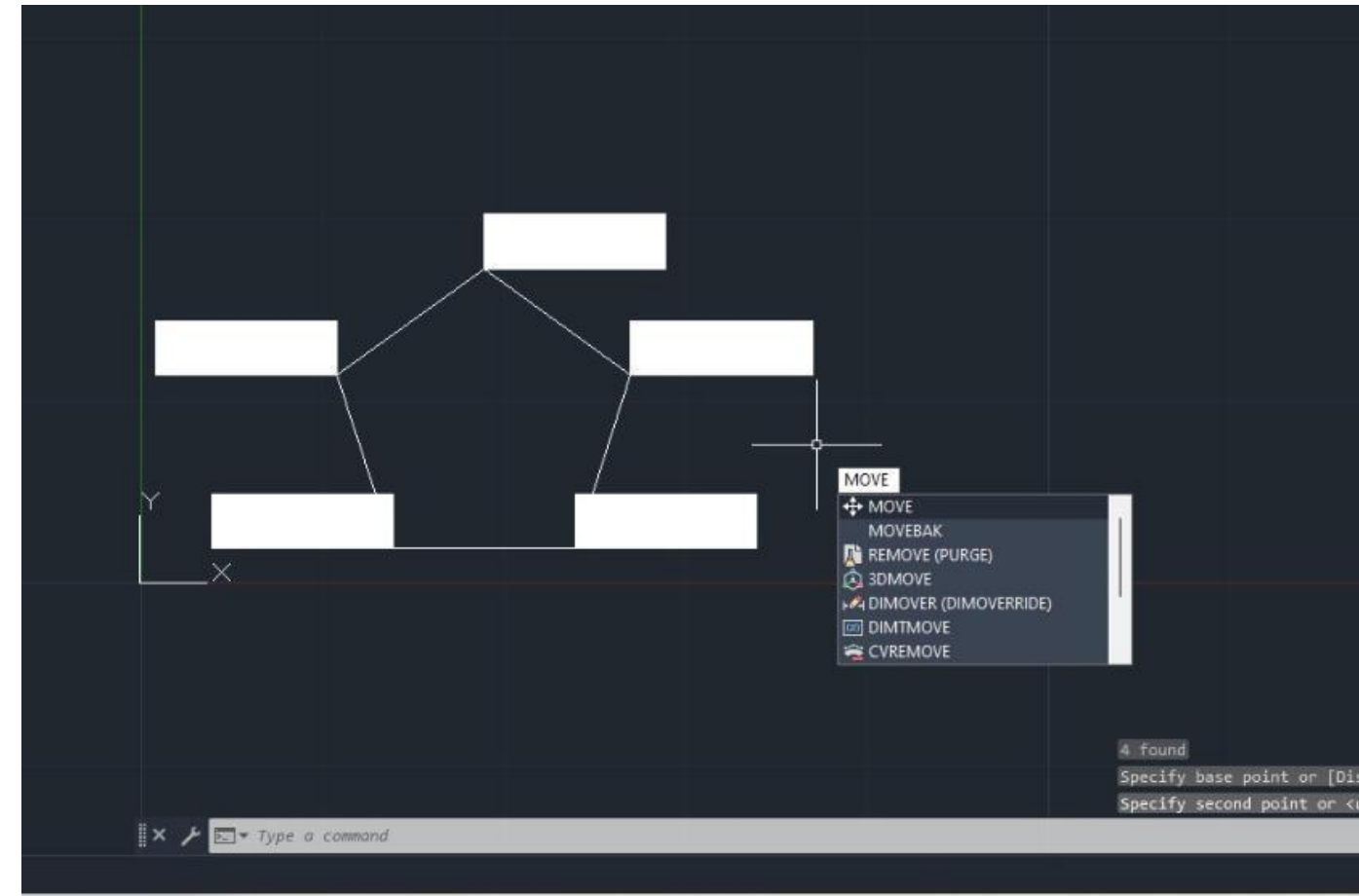

ReDig

Exerc. Intro AutoCAD



## SEMANA 2

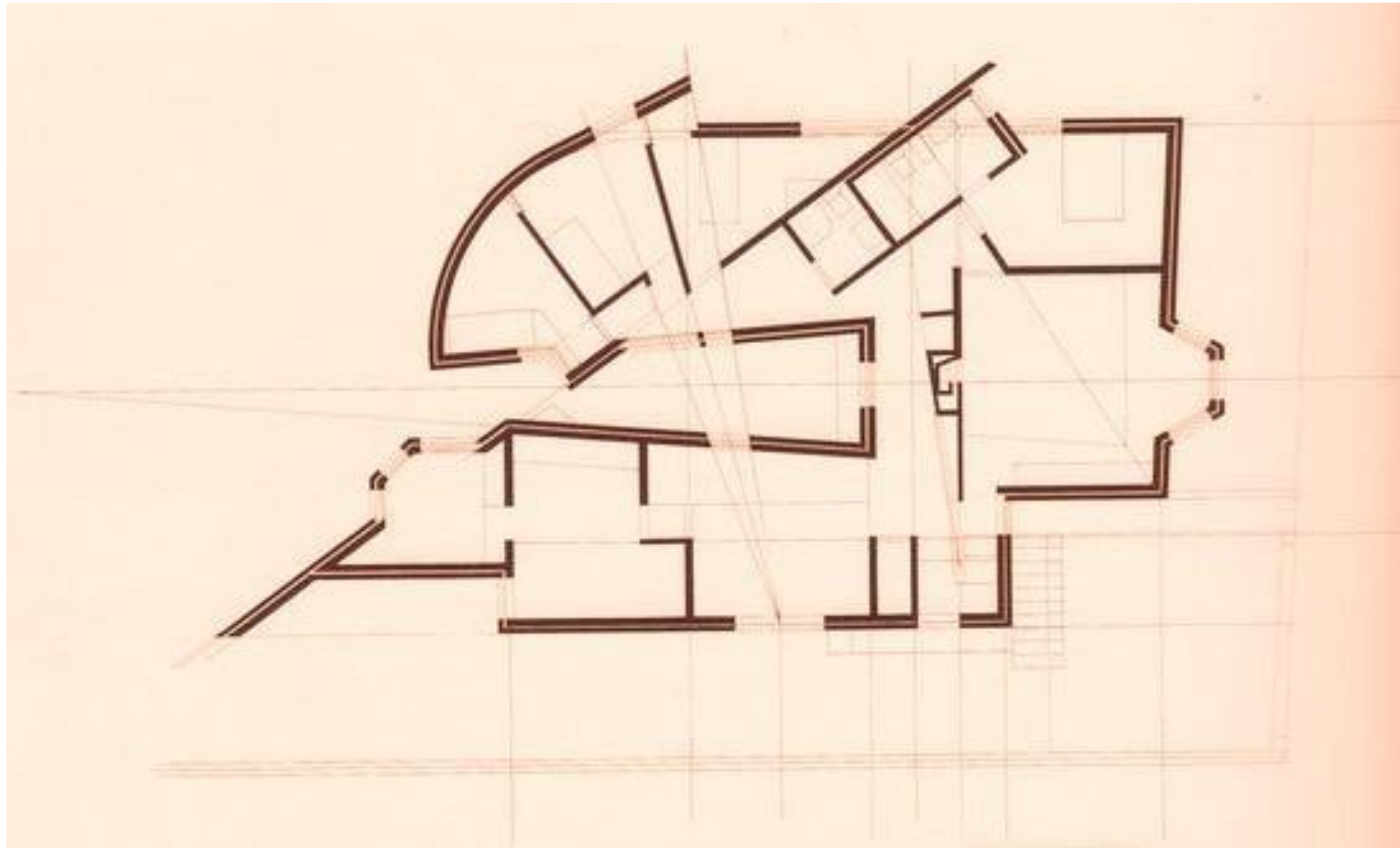

### Decalque da planta:

- Espessuras das paredes (exterior - interior):
  - 0,02 - reboco
  - 0,11 - tijolo
  - 0,045 - caixa de ar
  - 0,15 - tijolo
  - 0,02 - reboco

SEMANA 3

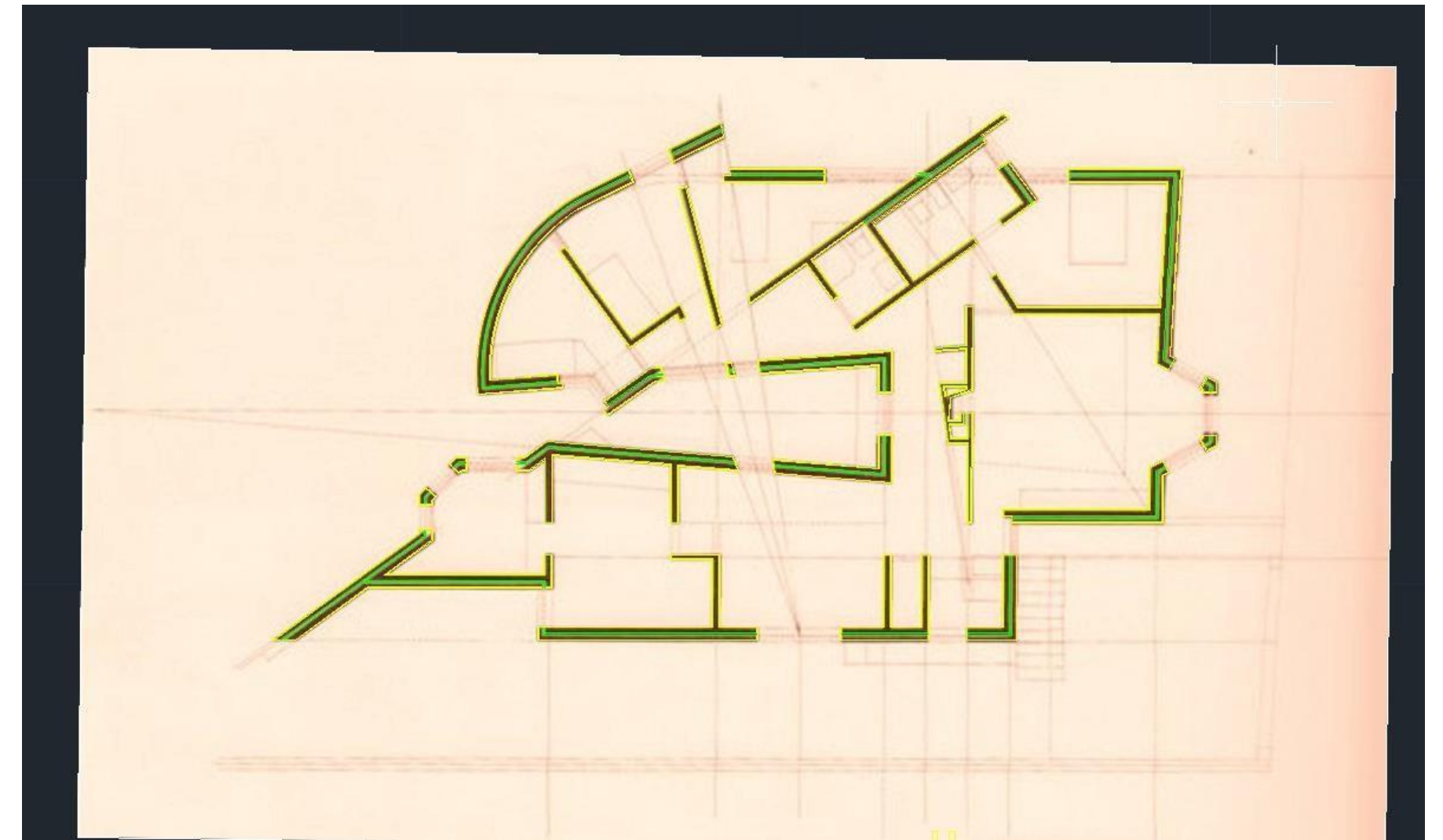
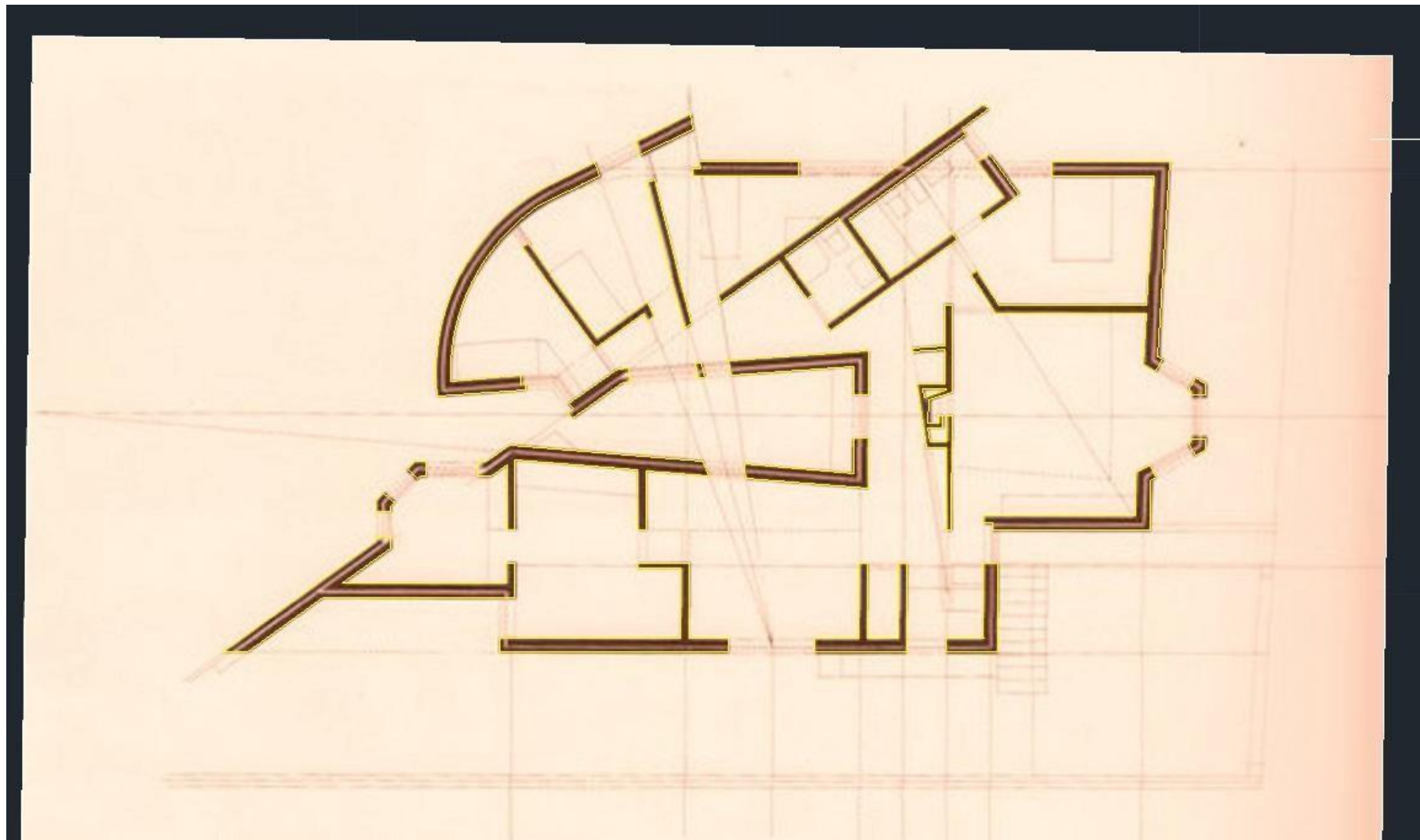

ReDig

Exerc. 1.1 – ACAD 2D

SEMANA 4

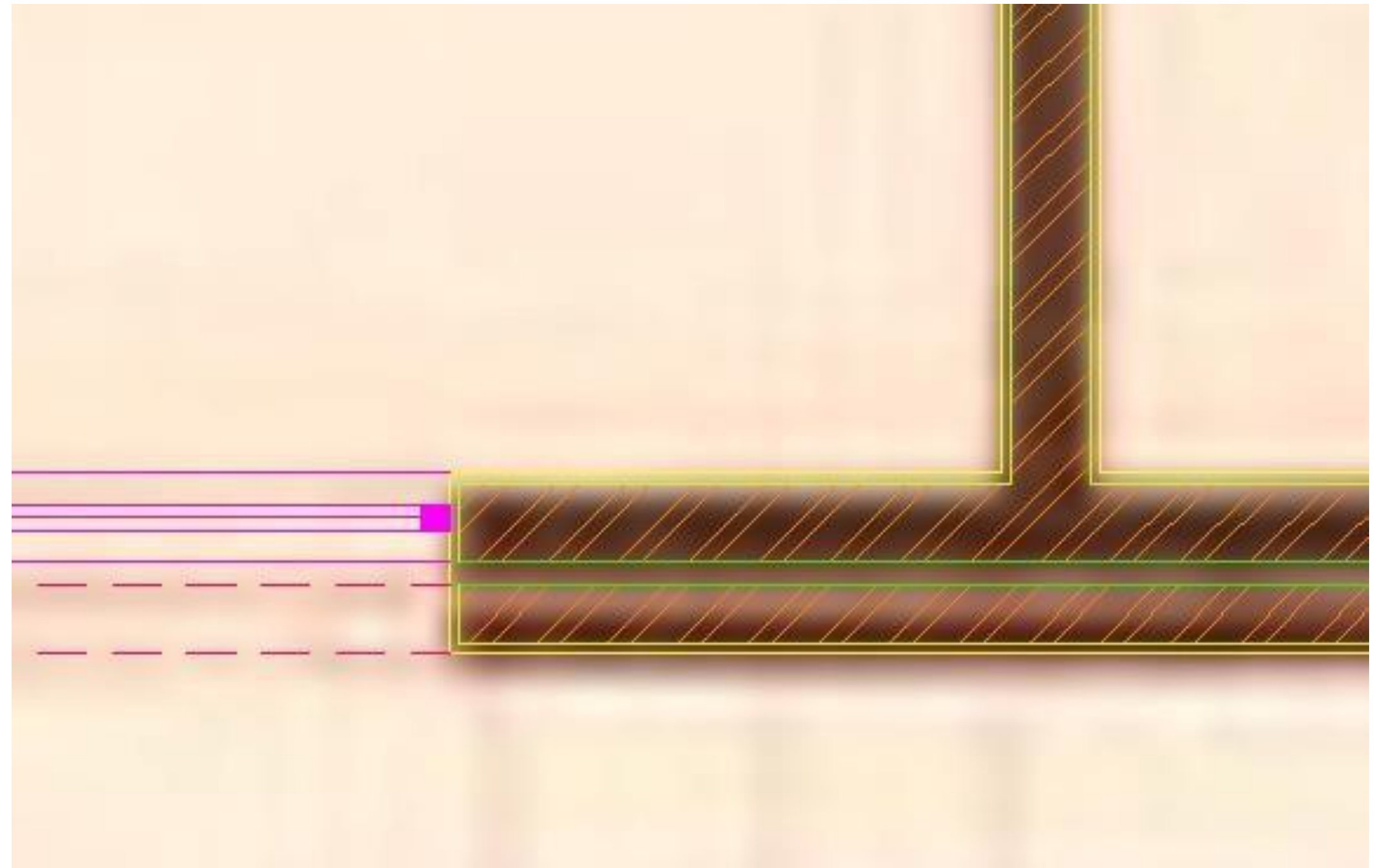
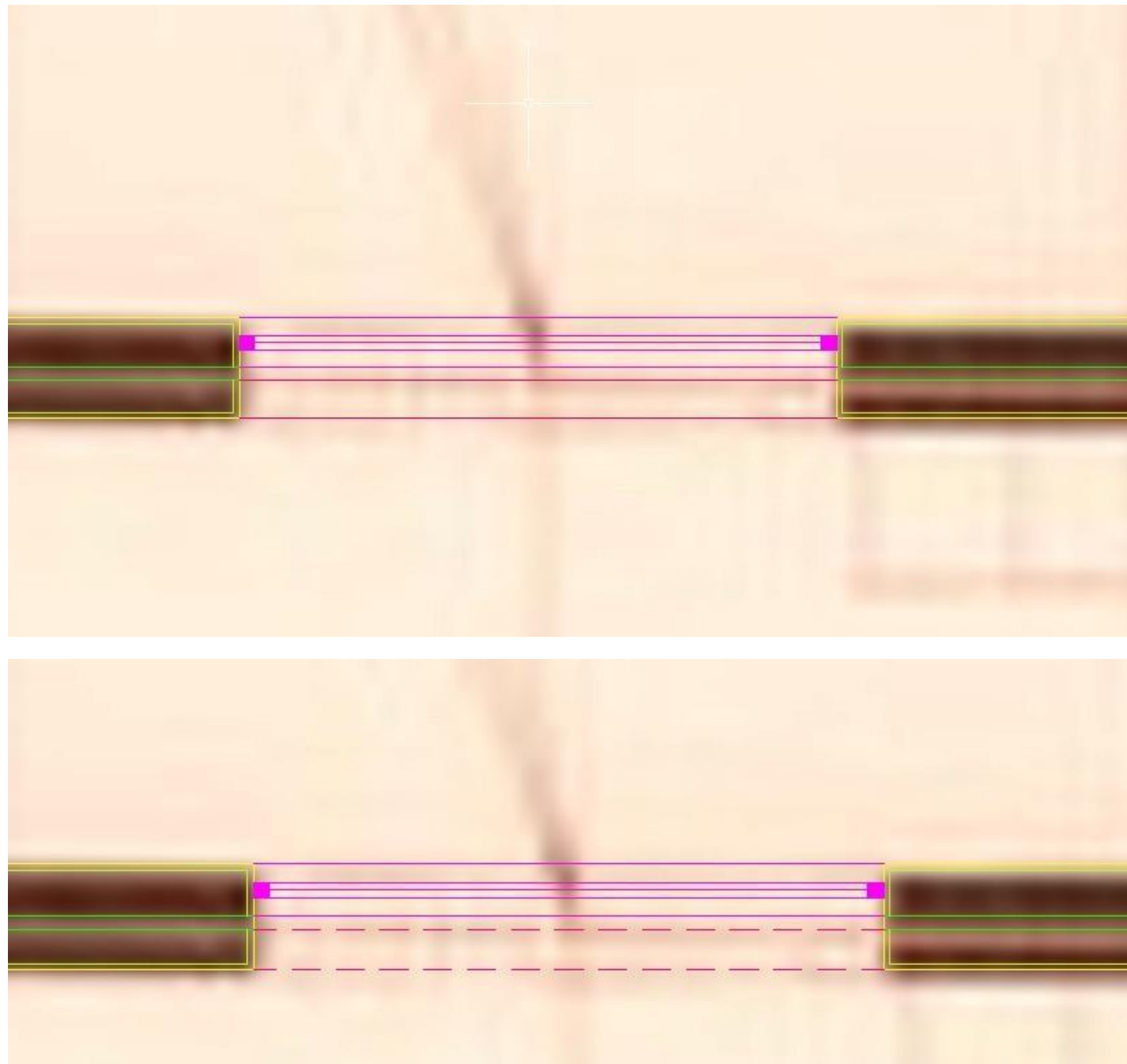

SEMANA 4

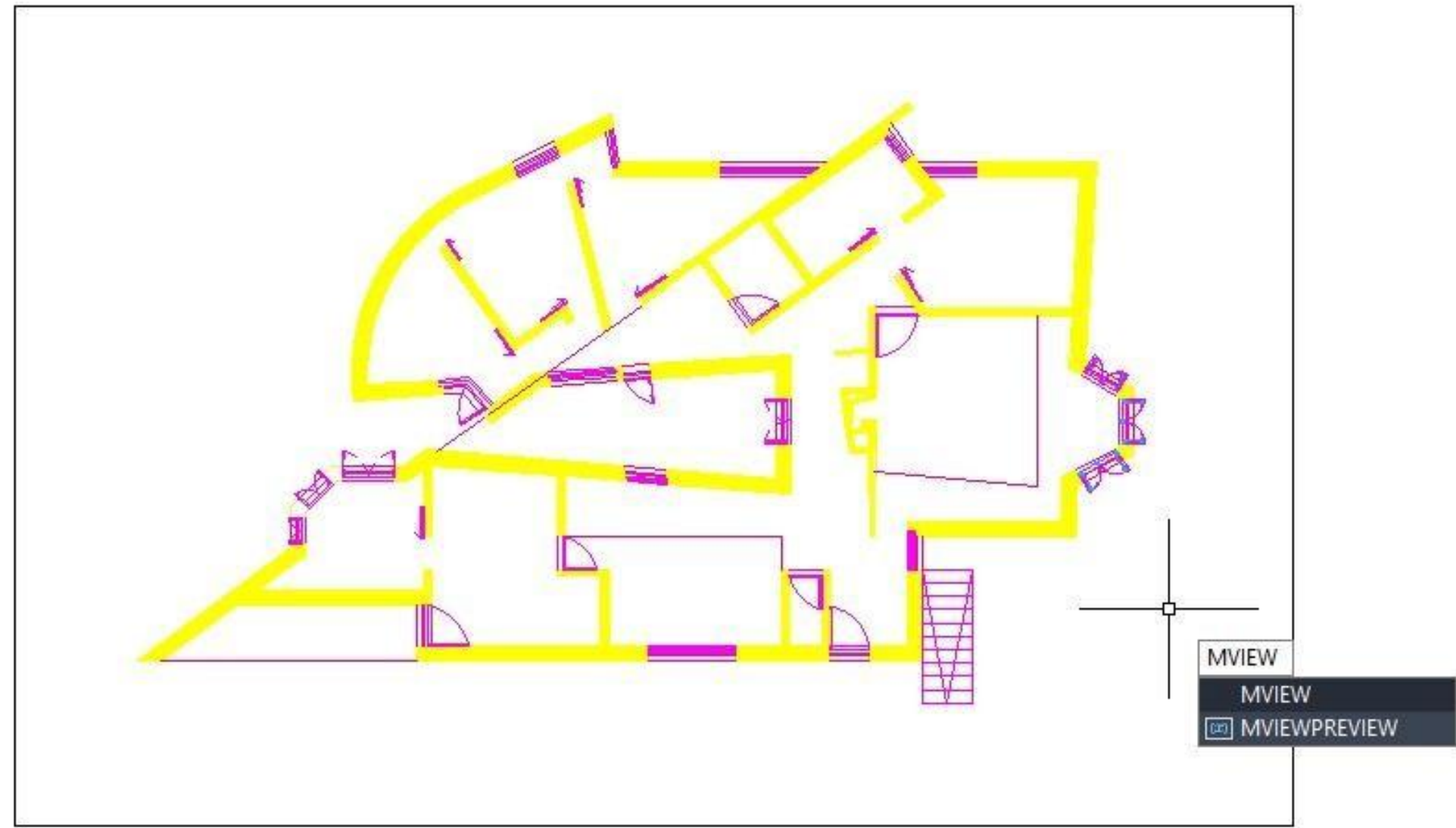
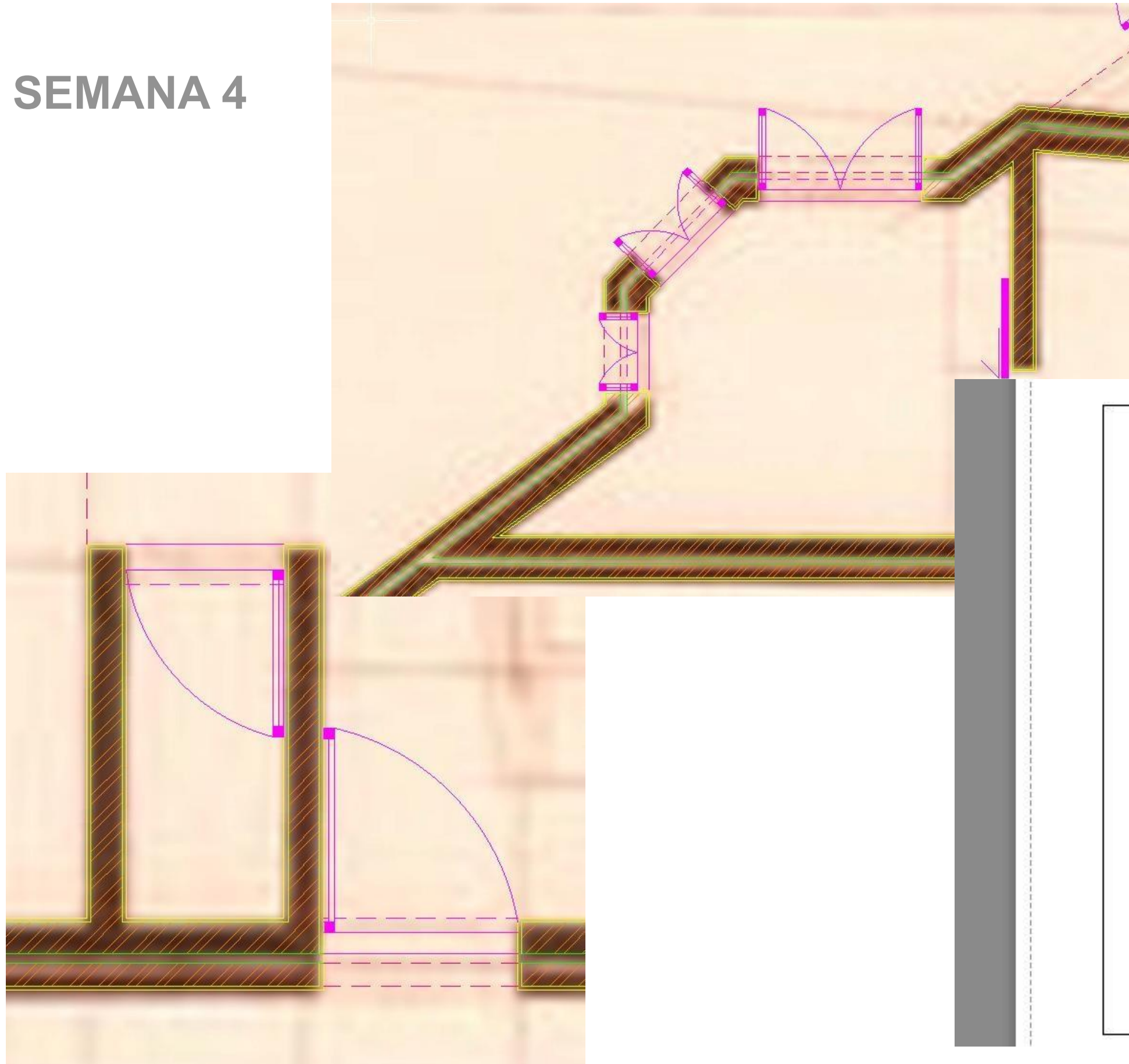

ReDig

Exerc. 1.1 – ACAD 2D

# SEMANA 5

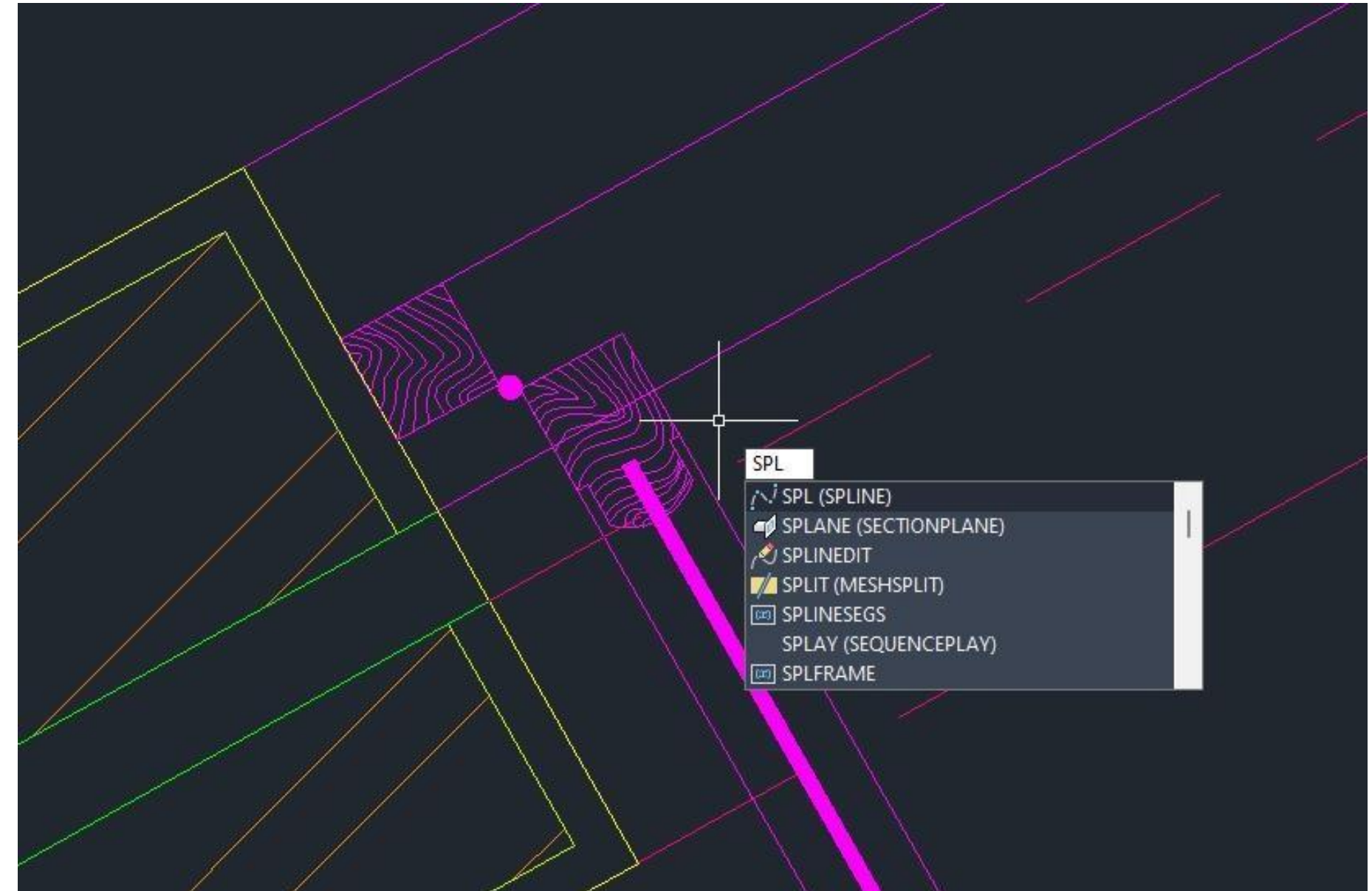
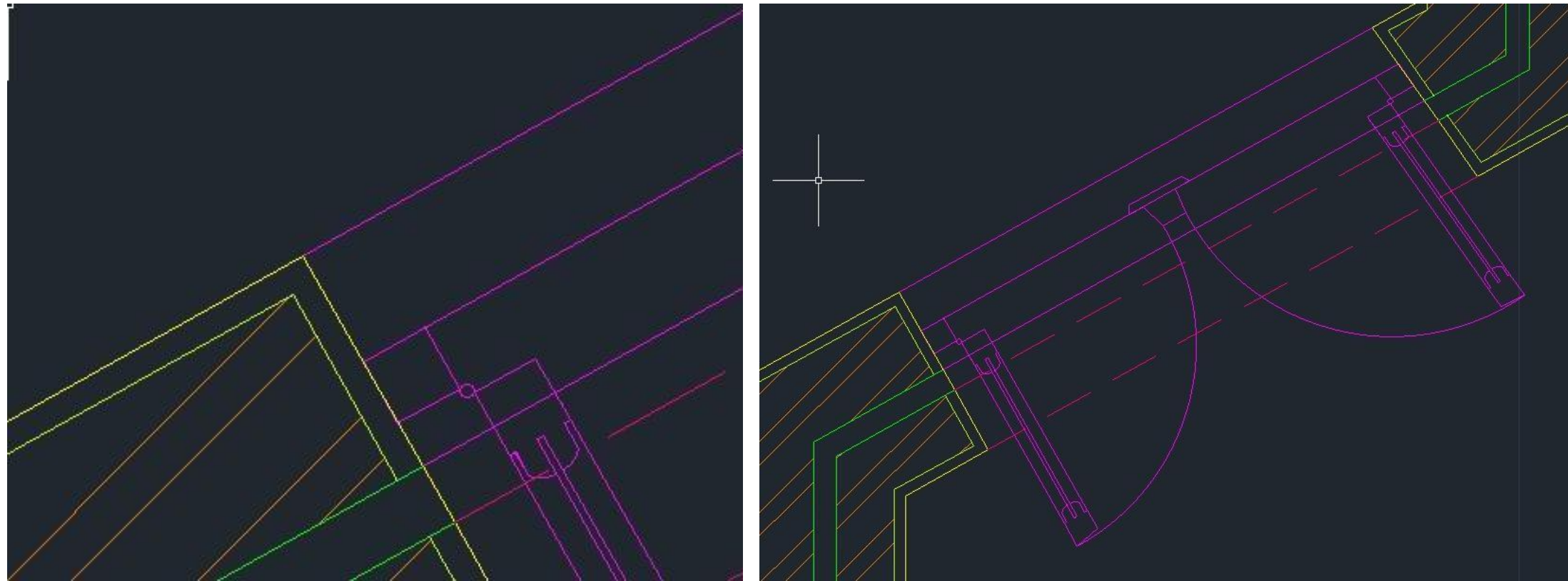

# SEMANA 6

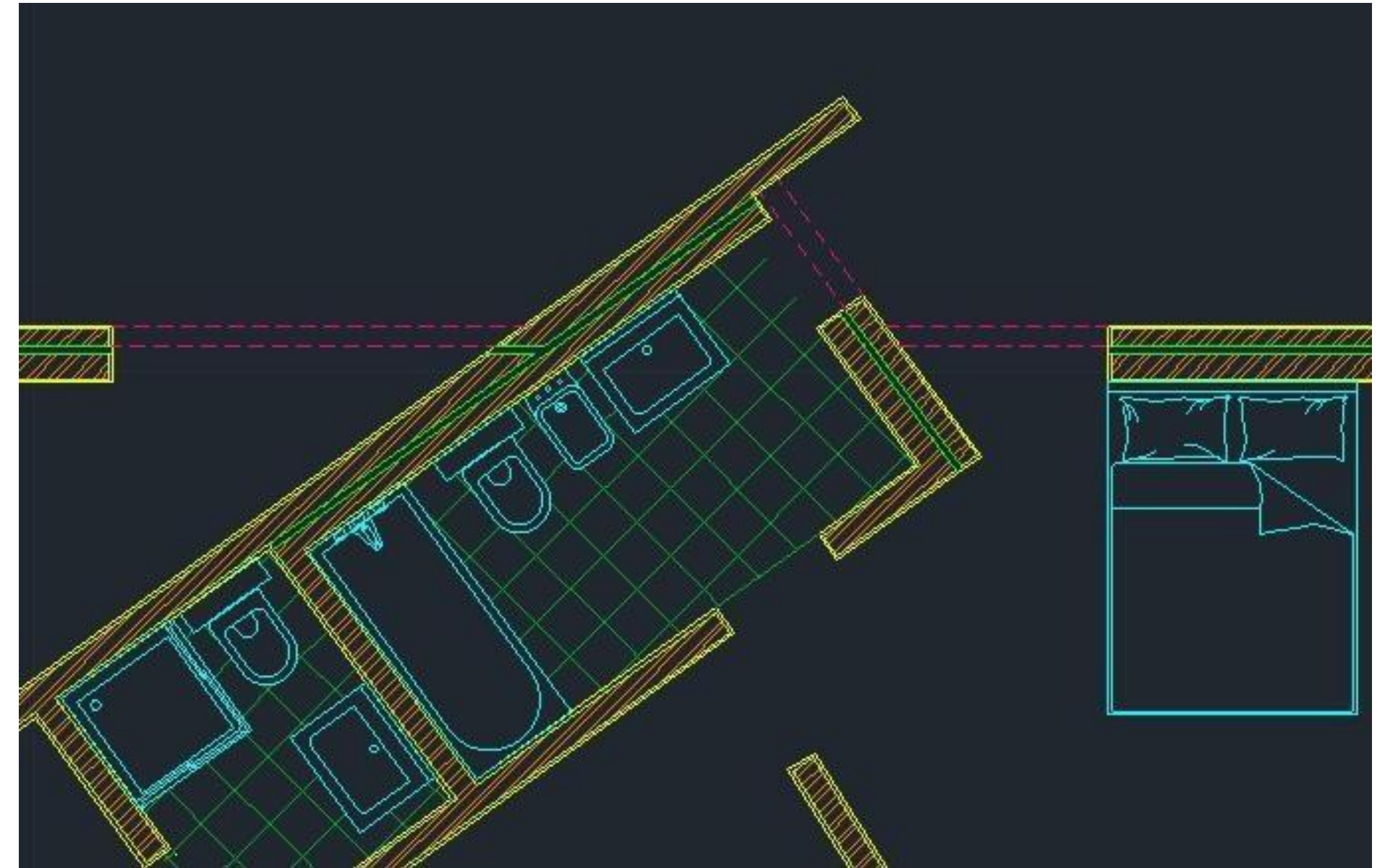
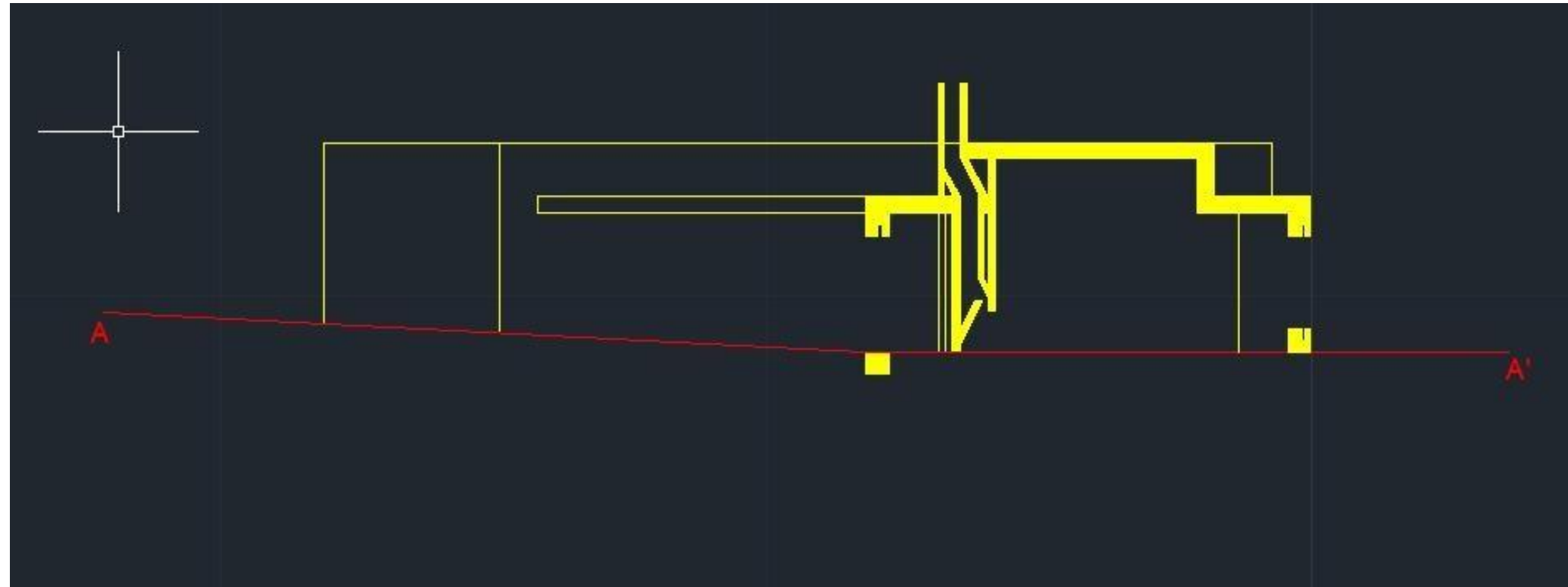

ReDig

Exerc. 1.1 – ACAD 2D

SEMANA 6

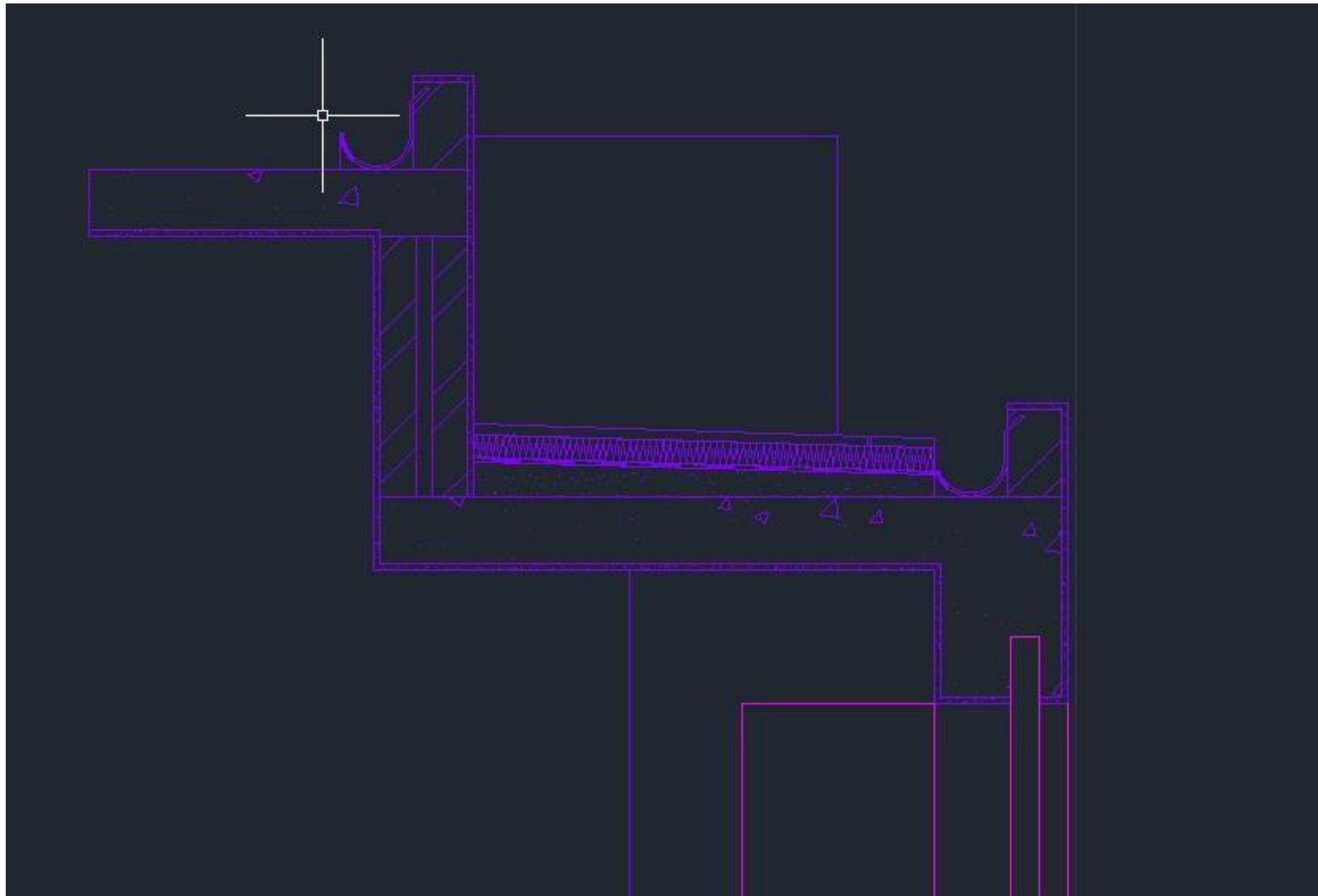

ReDig

Exerc. 1.1 – ACAD 2D

# SEMANA 7

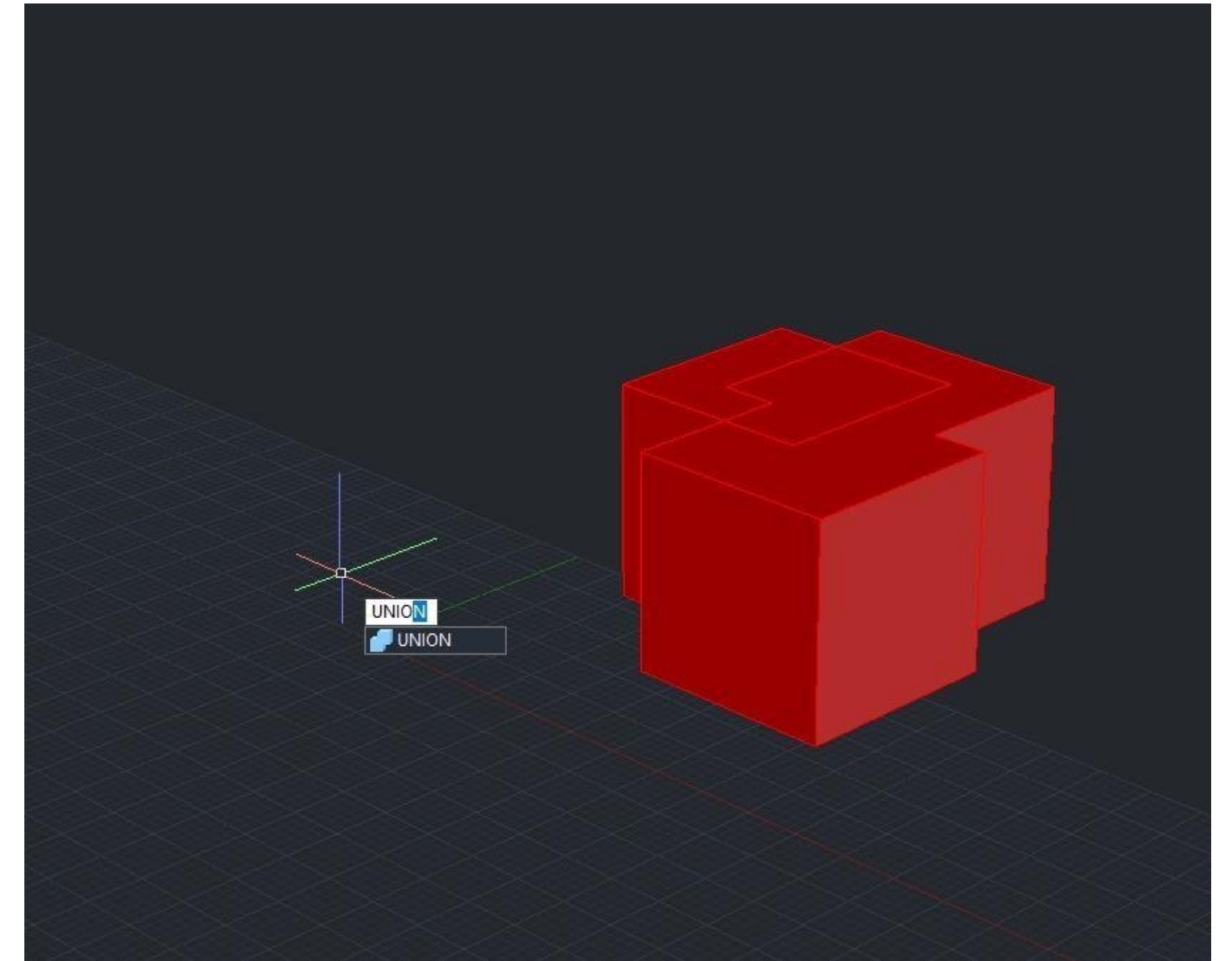
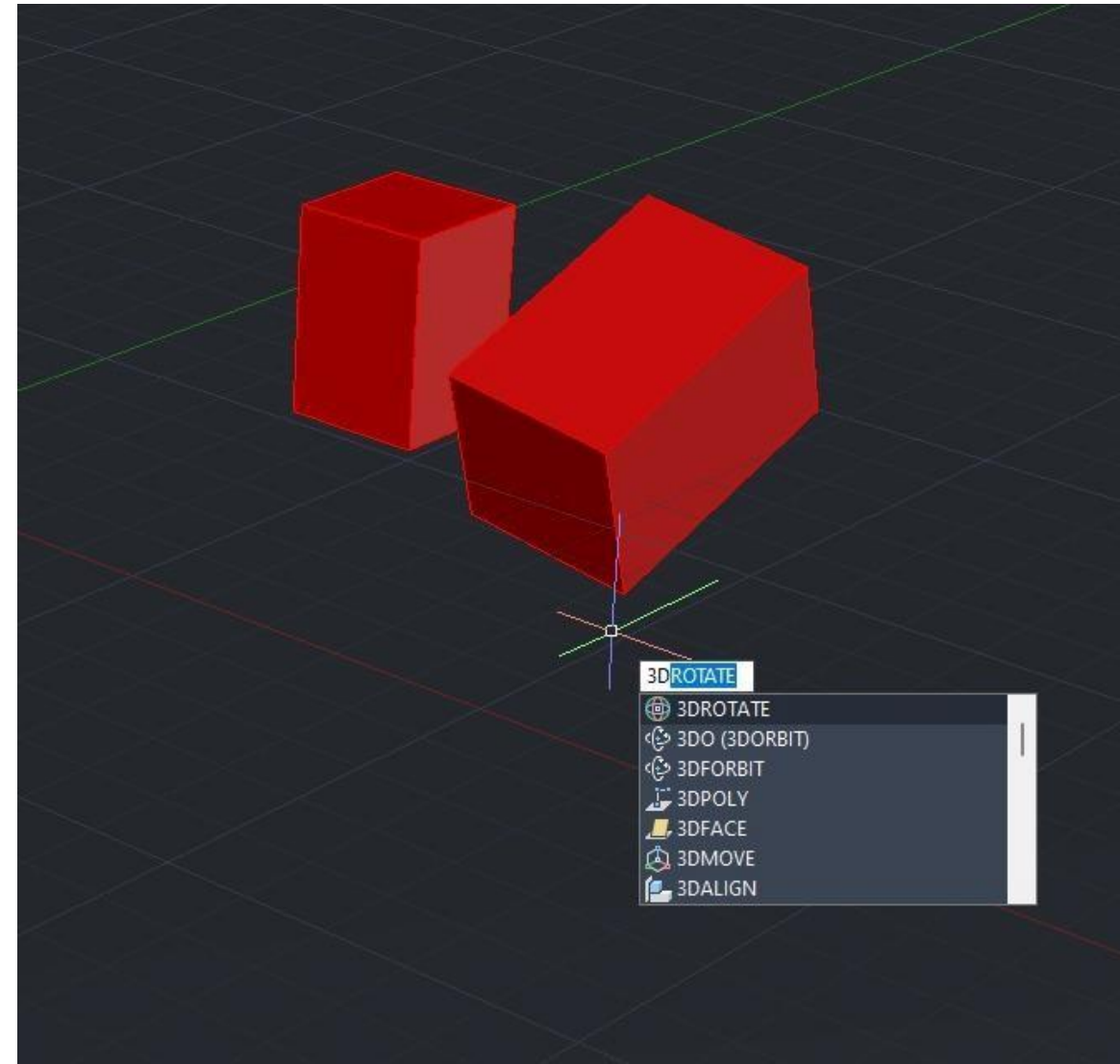
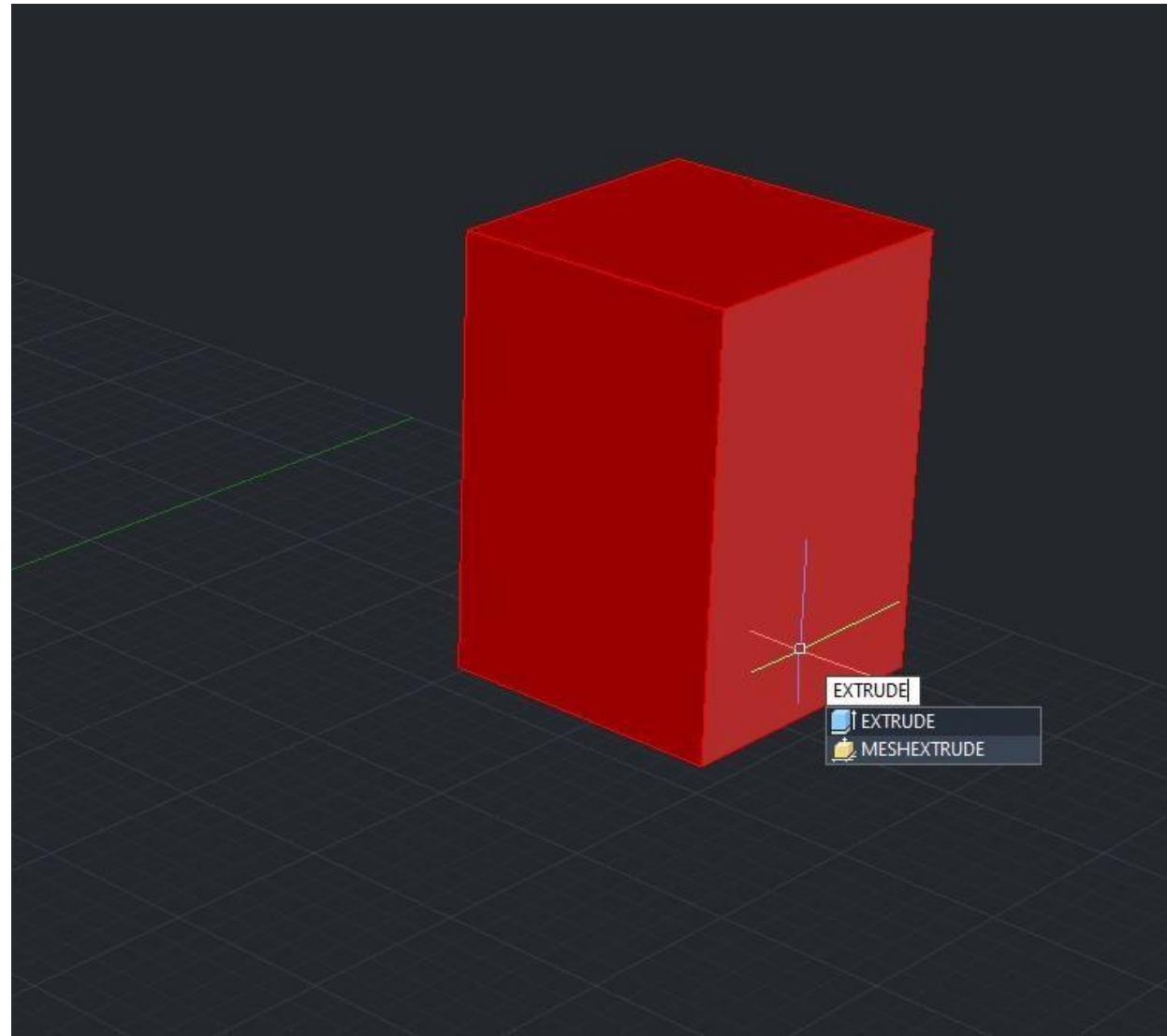



# SEMANA 8

## 01 CASA ANTÓNIO SIZA

Representação Digital - 1º Semestre  
Prof. Nuno Alão

Matilde Nunes  
Nº 20221292  
MIARQ Turma 2E

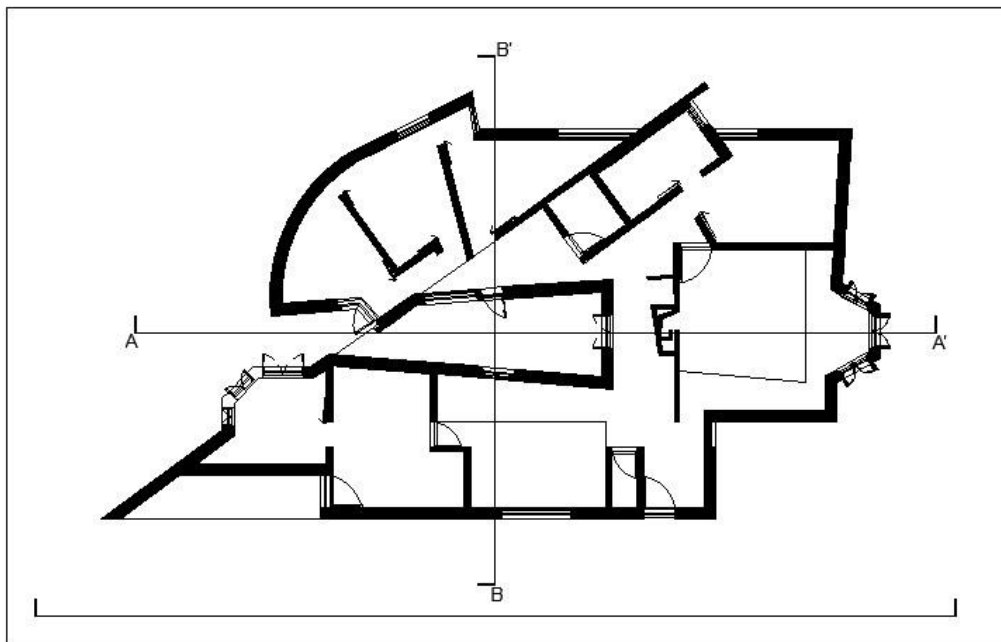

Planta 1:100

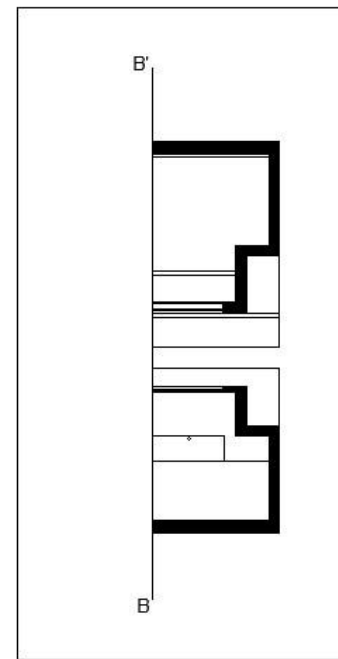

Corte transversal BB' 1:100

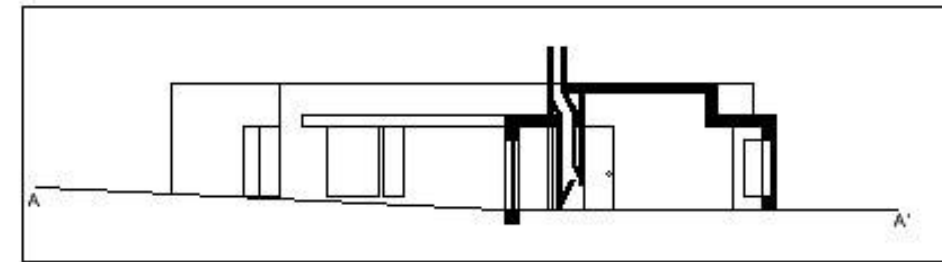

Corte longitudinal AA' 1:100

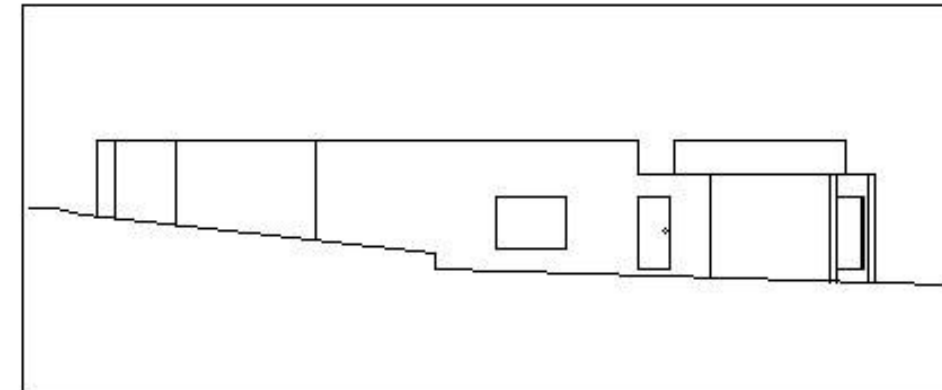

Alçado Sudoeste 1:100

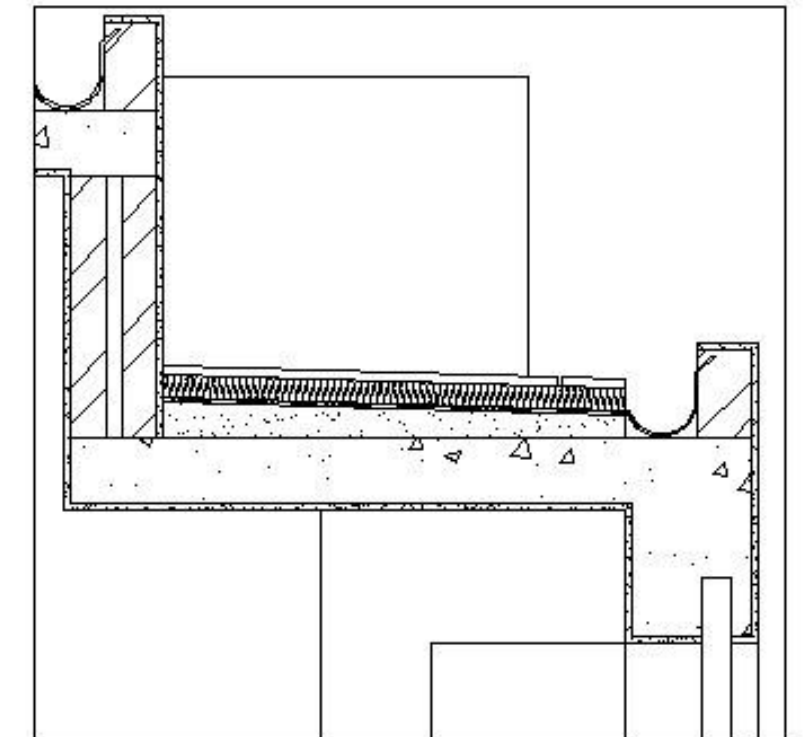

Promenor cobertura 1:5

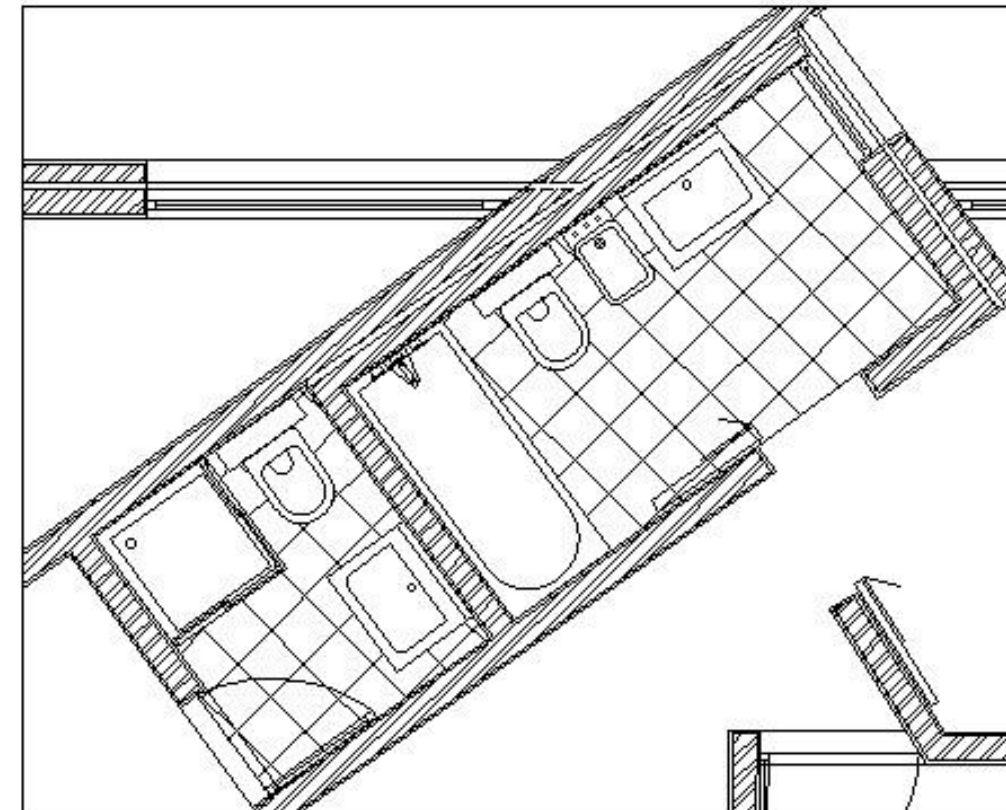

Promenor casa de banho 1:20

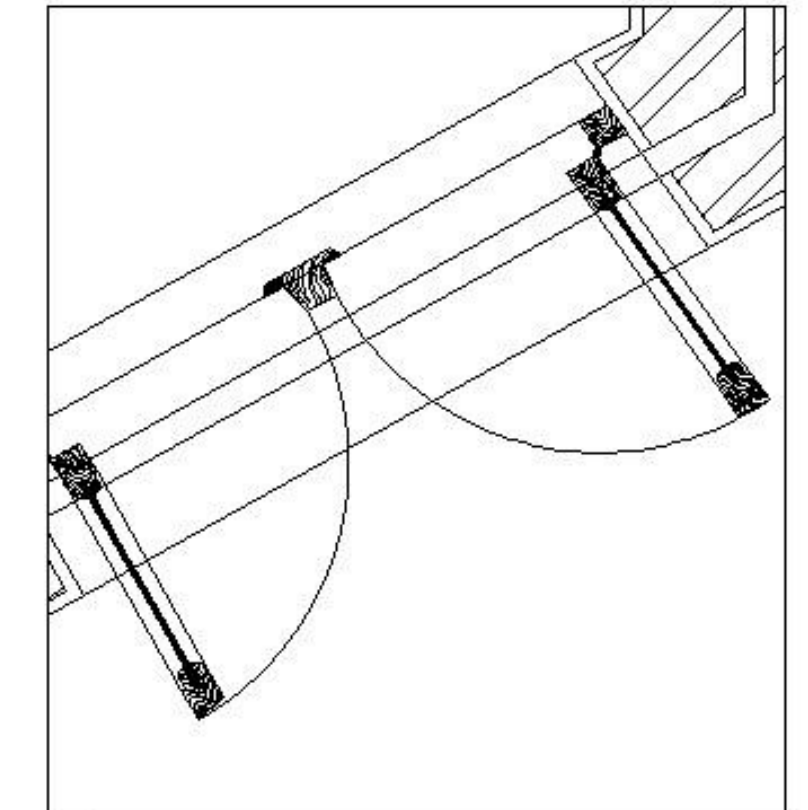

Detalhe caixilharia 1:5

# SEMANA 8

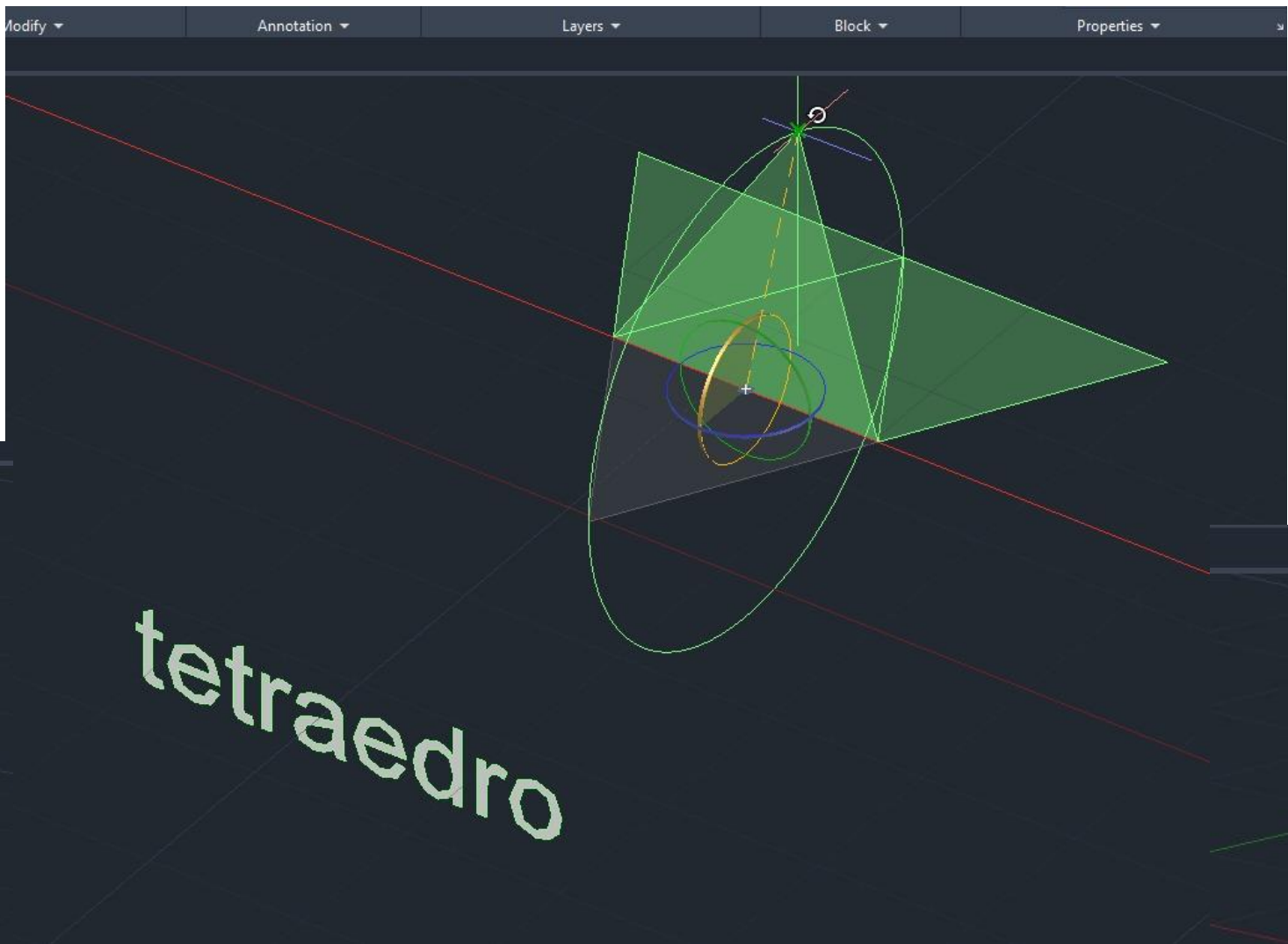

# SEMANA 8

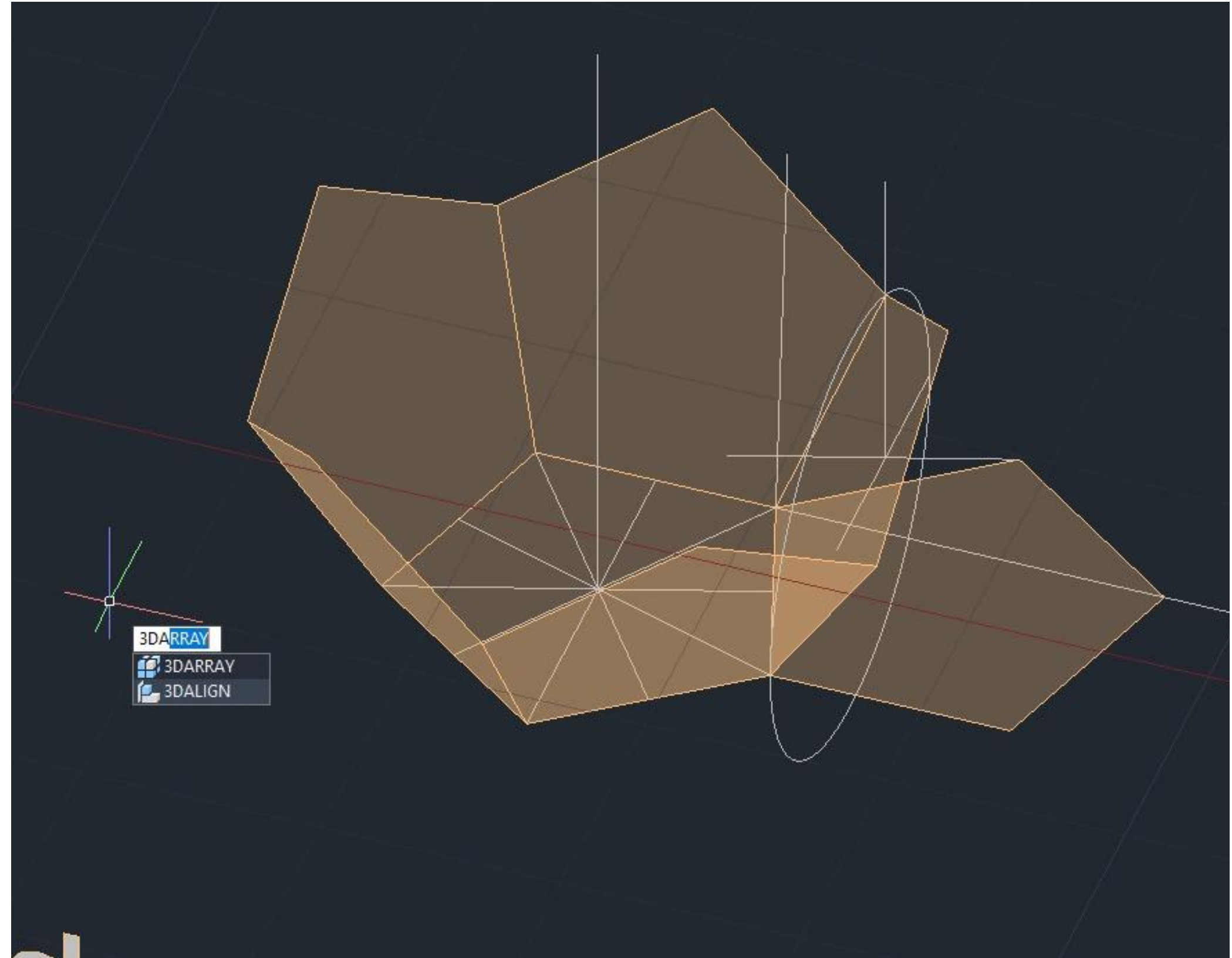
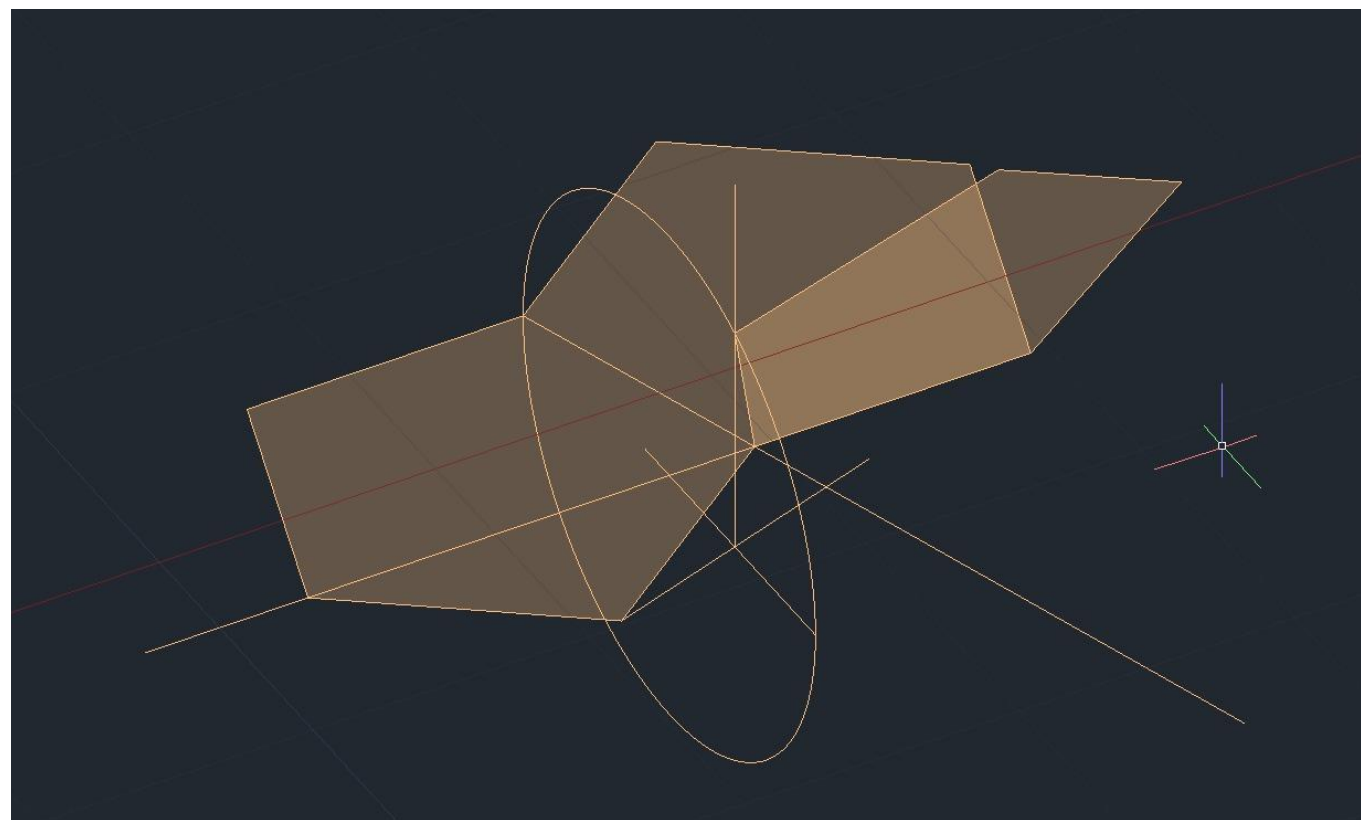
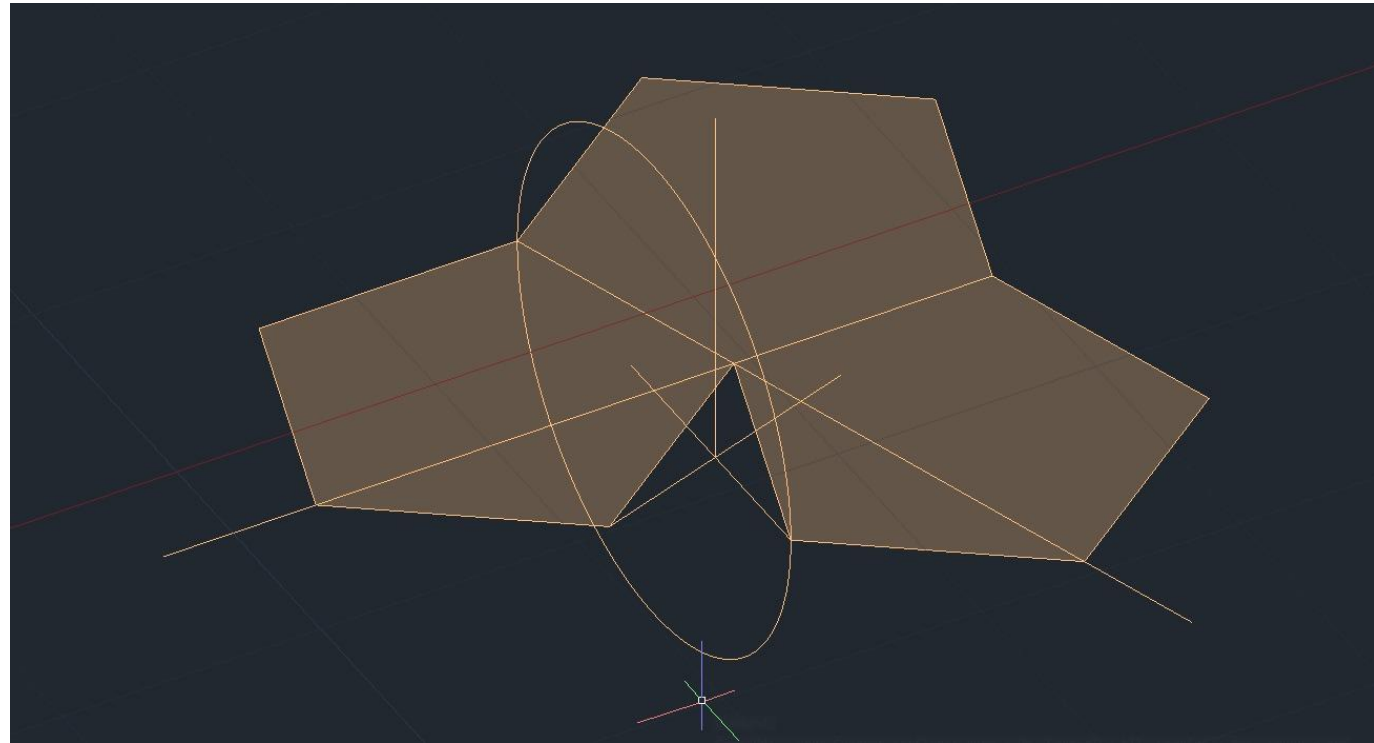

ReDig

Exerc. 2 – ACAD 3D

SEMANA 8

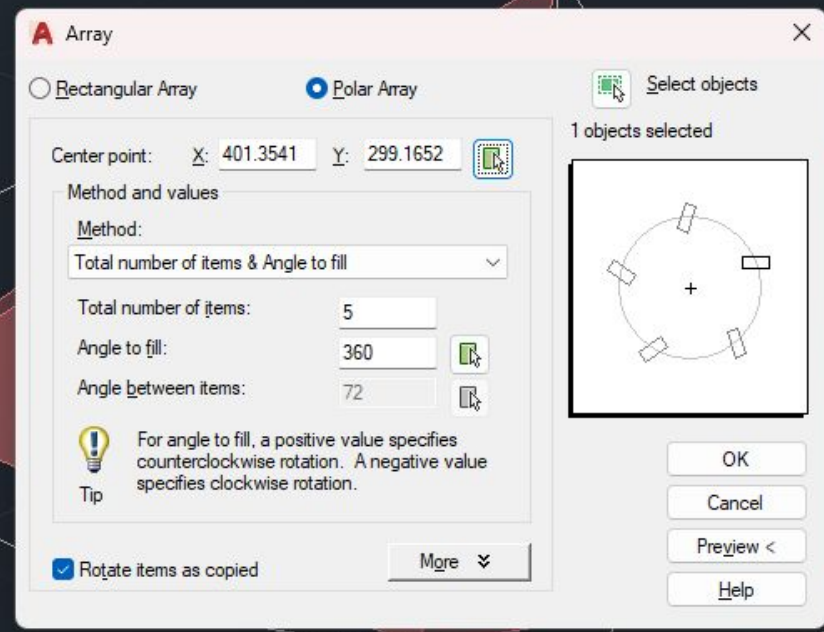
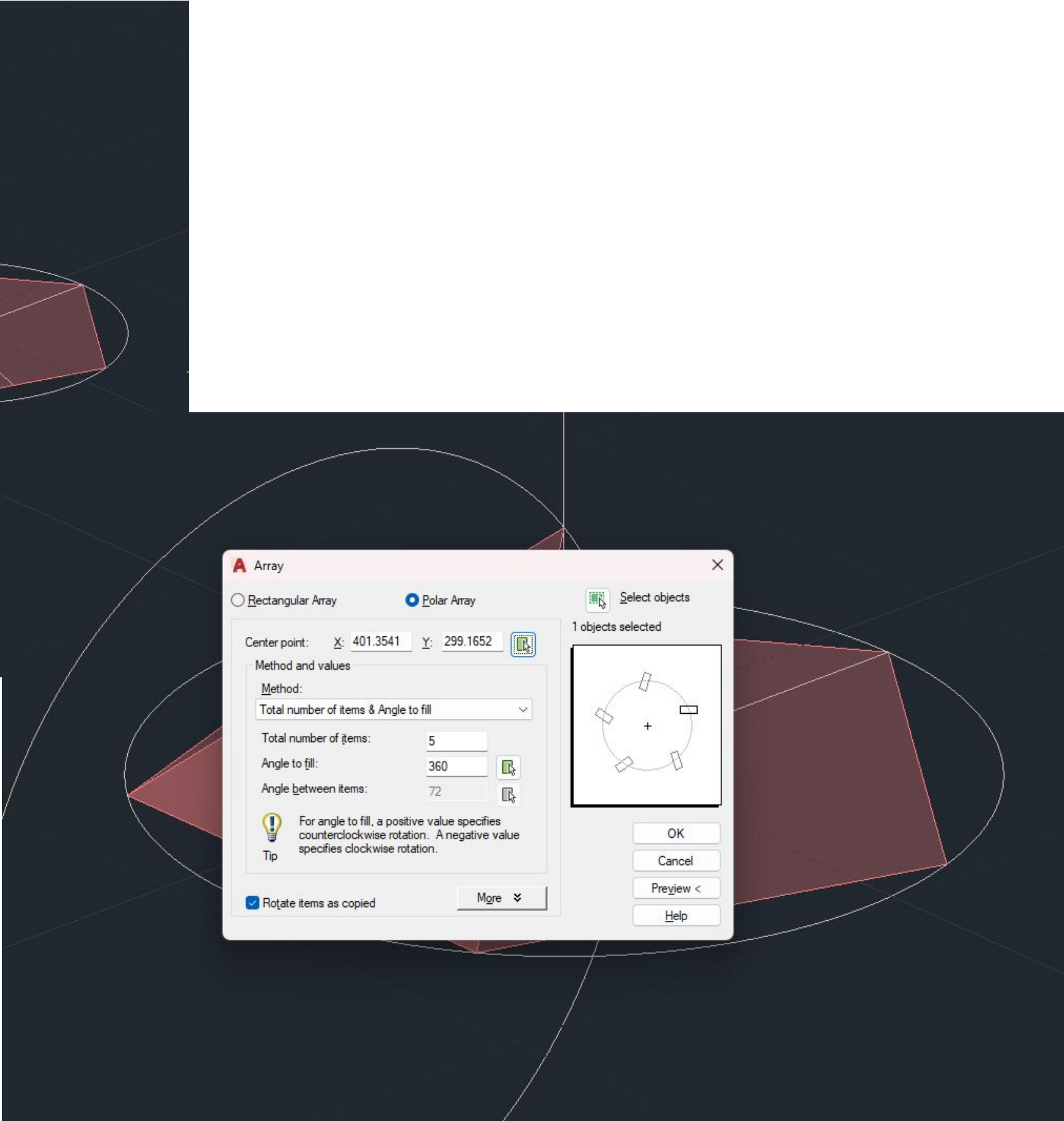
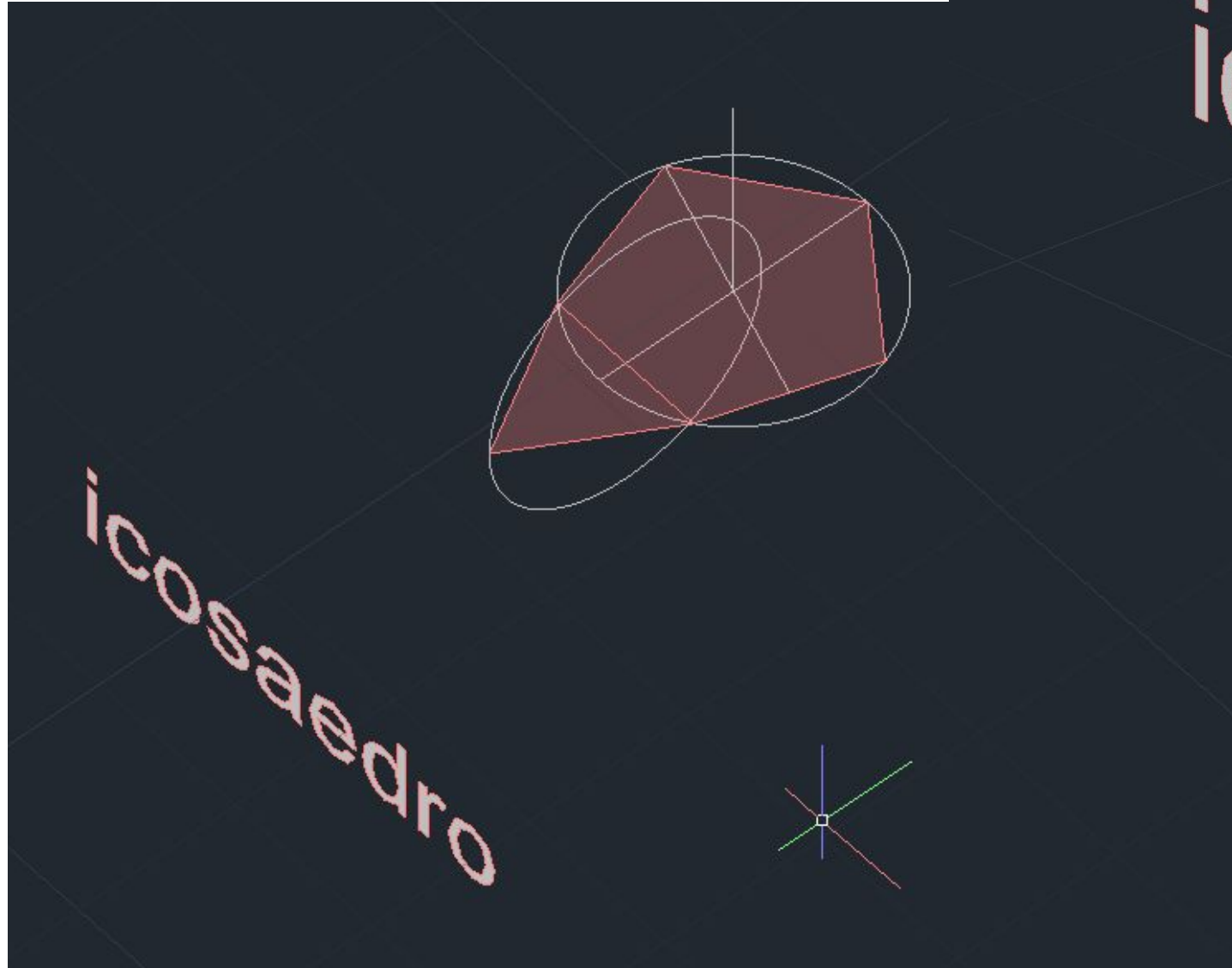
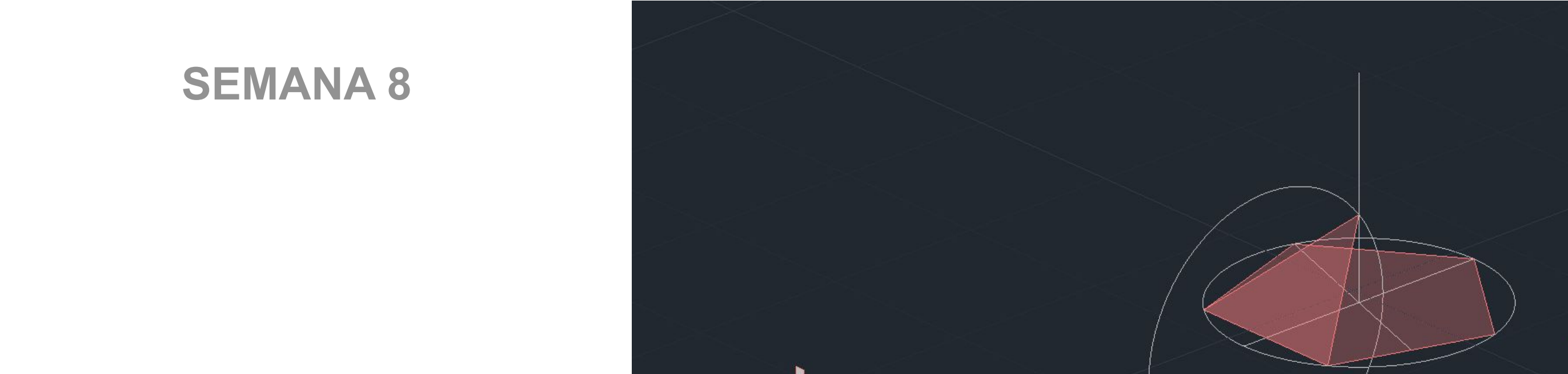



SEMANA 8



SEMANA 9

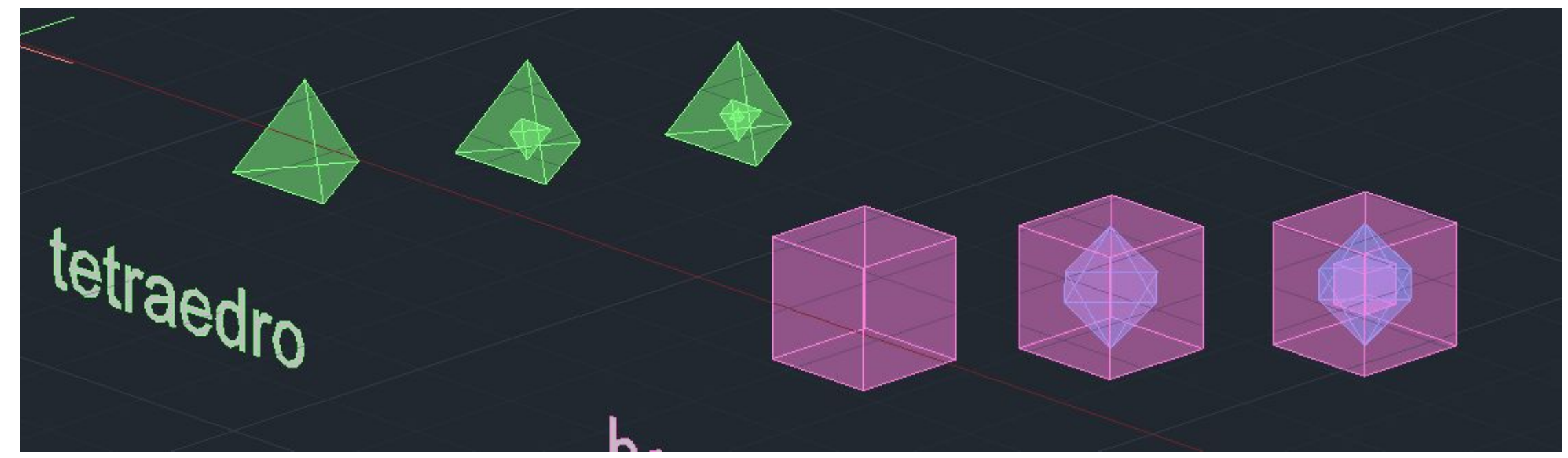
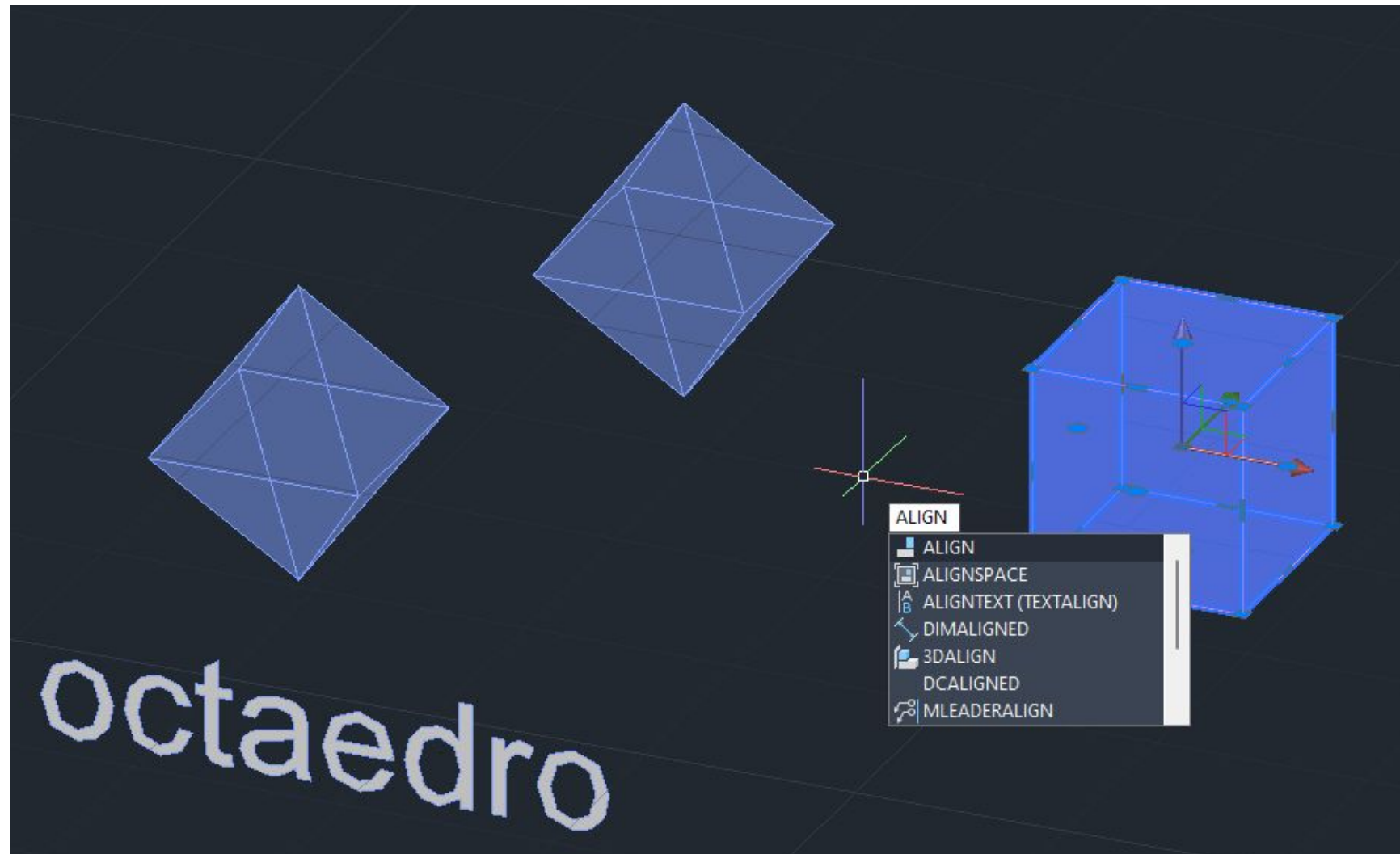

SEMANA 9

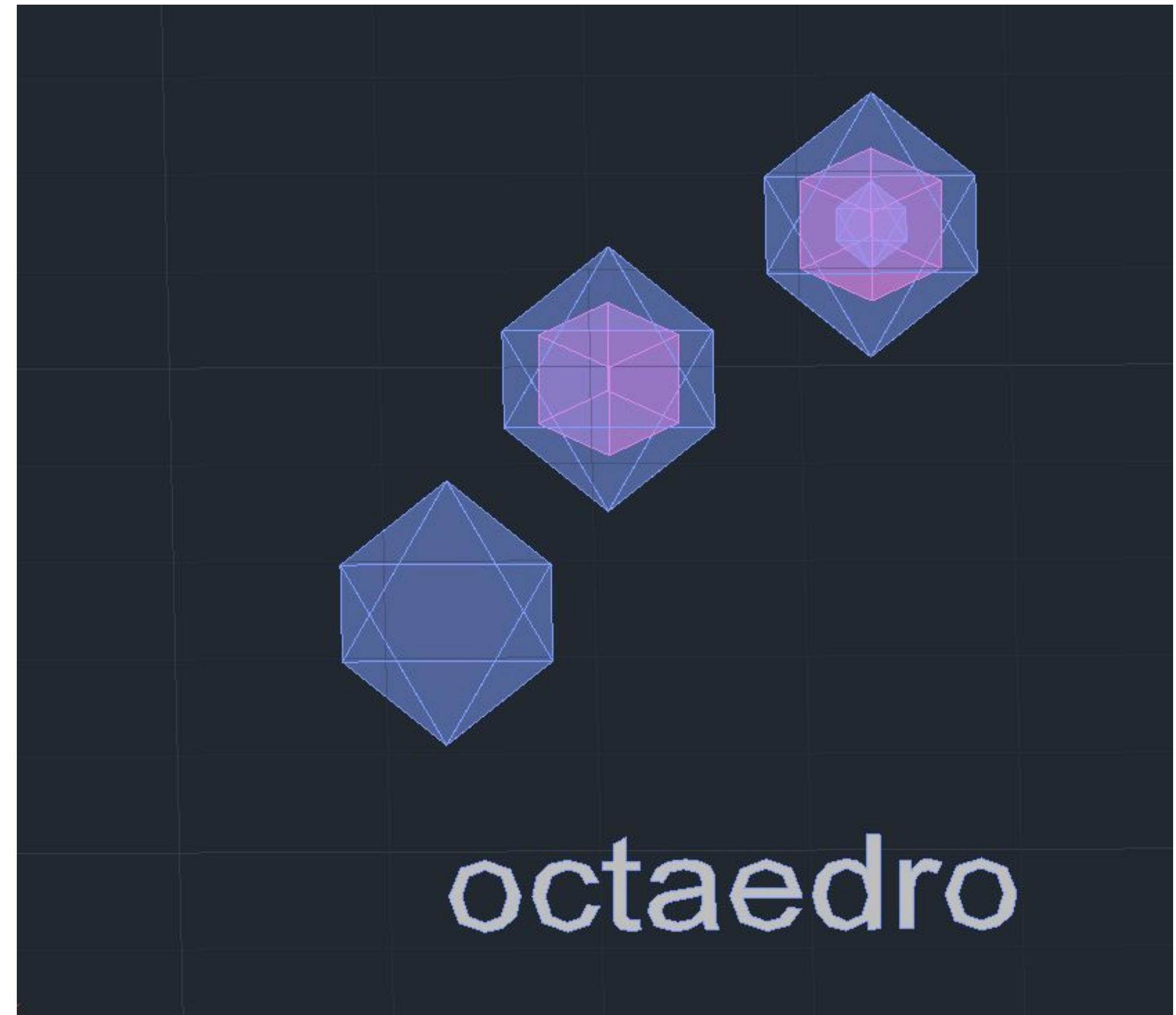

ReDig

Exerc. 2 – ACAD 3D



SEMANA 9

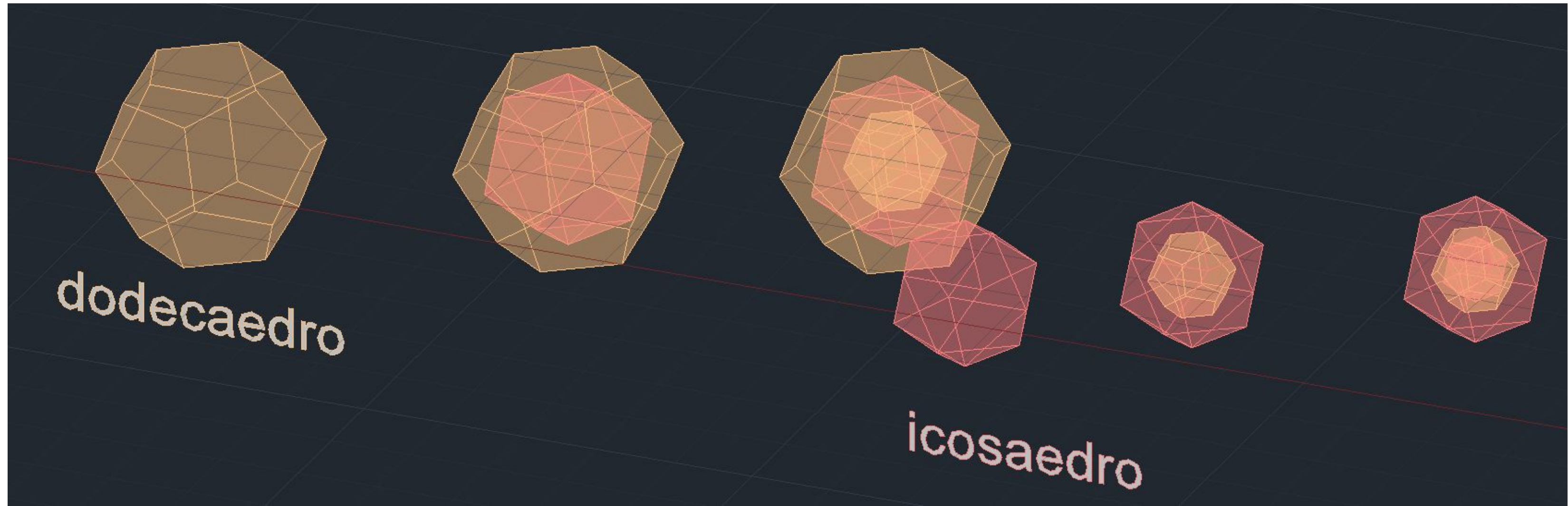

# SEMANA 10

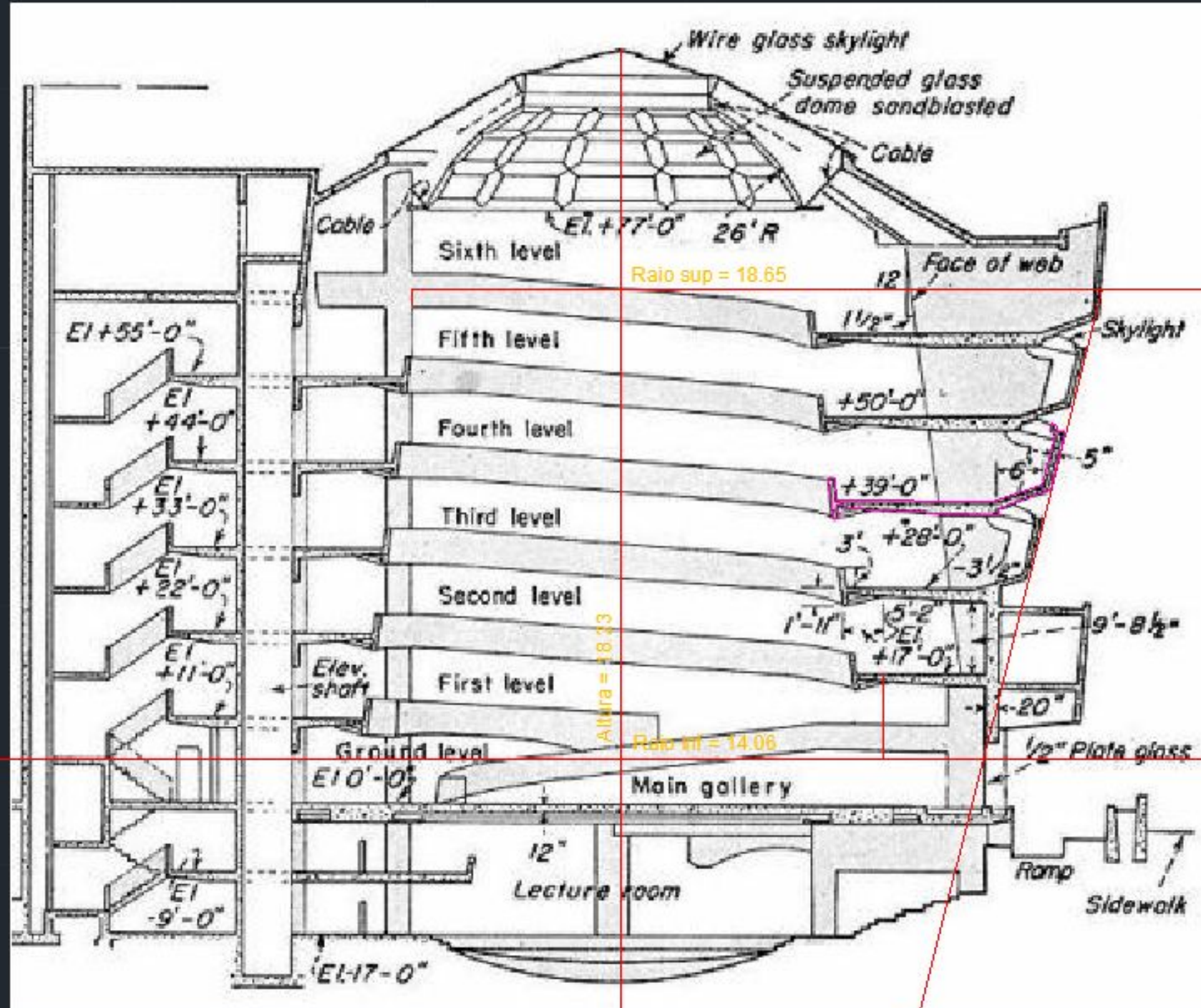

ReDig

Exerc. 3 – ACAD 3D

SEMANA 10

ReDig

Exerc. 3 – ACAD 3D