

Representação Digital

2023-2024

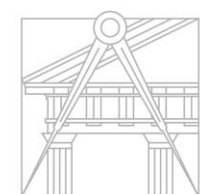

20221228



JOSÉ MOTA BARBOSA

ÍNDICE

ReDig

Exerc. 1.1 – ACAD 2D

Aula 1 - 21 de setembro

- Introdução à cadeira
- Início da criação da página index

Aula 2 - 22 de setembro

- Continuação da criação da página index, para entrega de trabalhos e sumários

Aula 3 - 28 de setembro

- Introdução ao uso do software Autocad

Aula 4 - 29 de setembro

- Começo da realização e introdução do trabalho 1

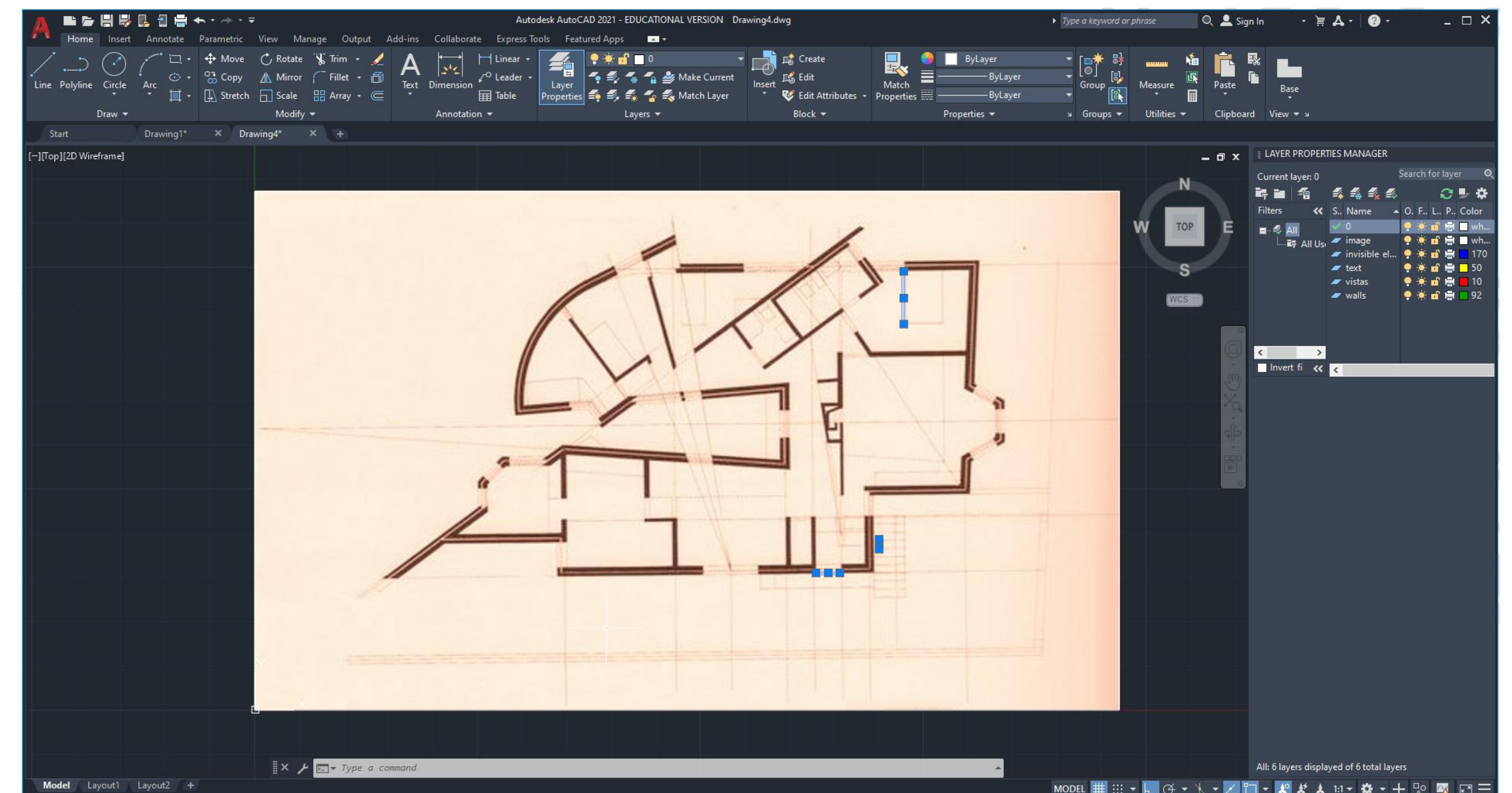
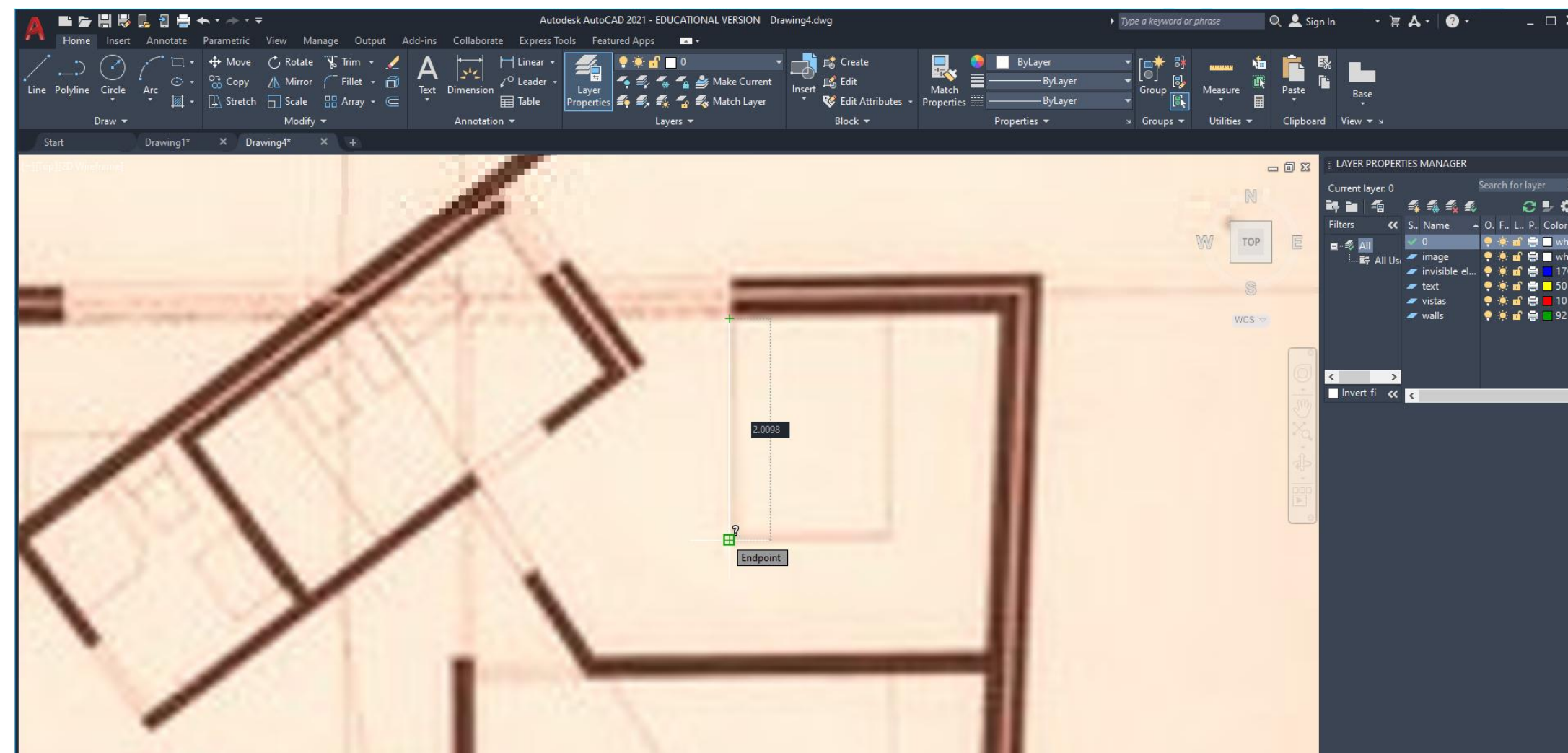

Aula 5 - 6 de Outubro

- Continuação do desenho da planta

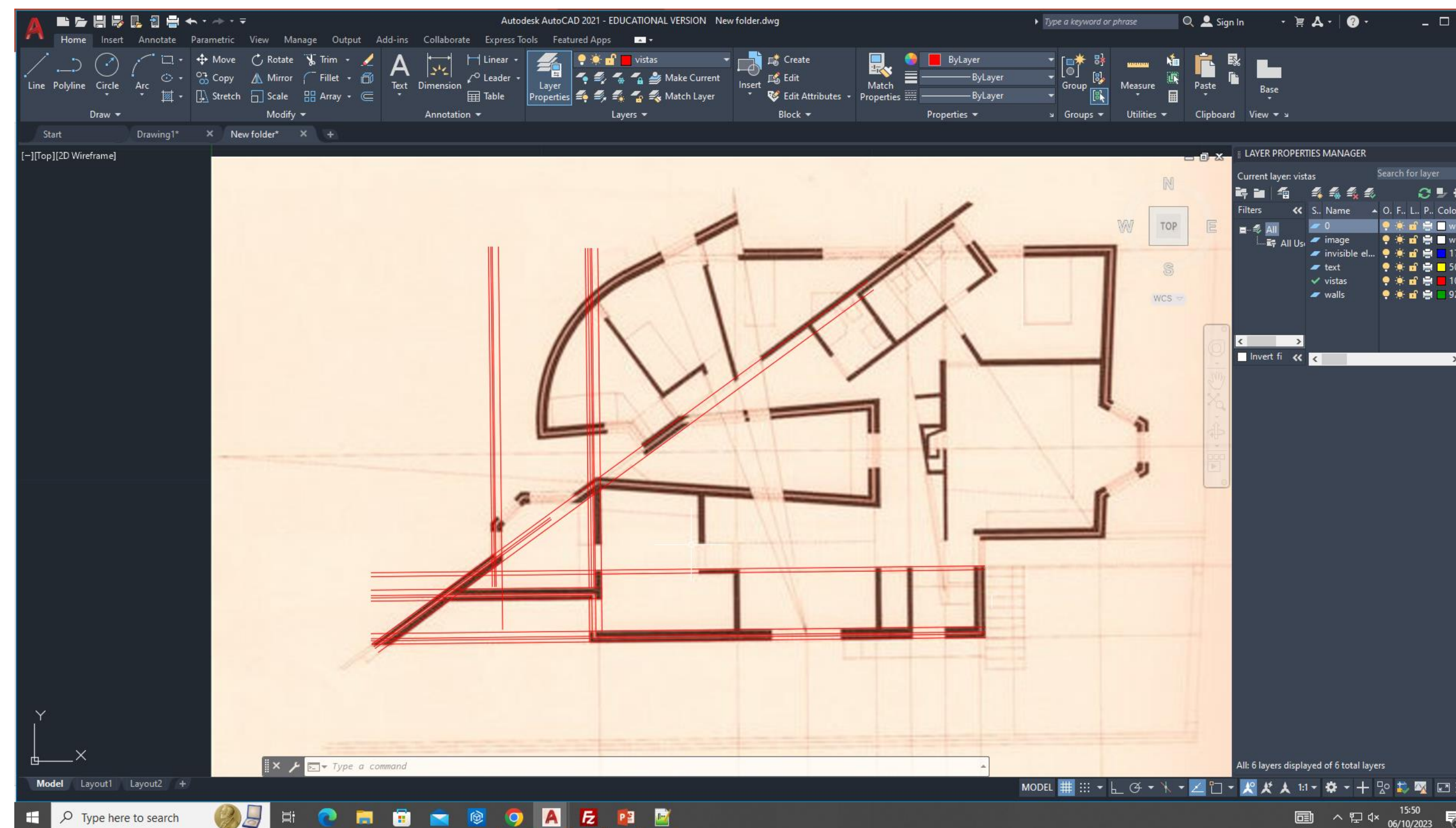

Aula 6 - 12 de Outubro

- Continuação do desenvolvimento do trabalho 1

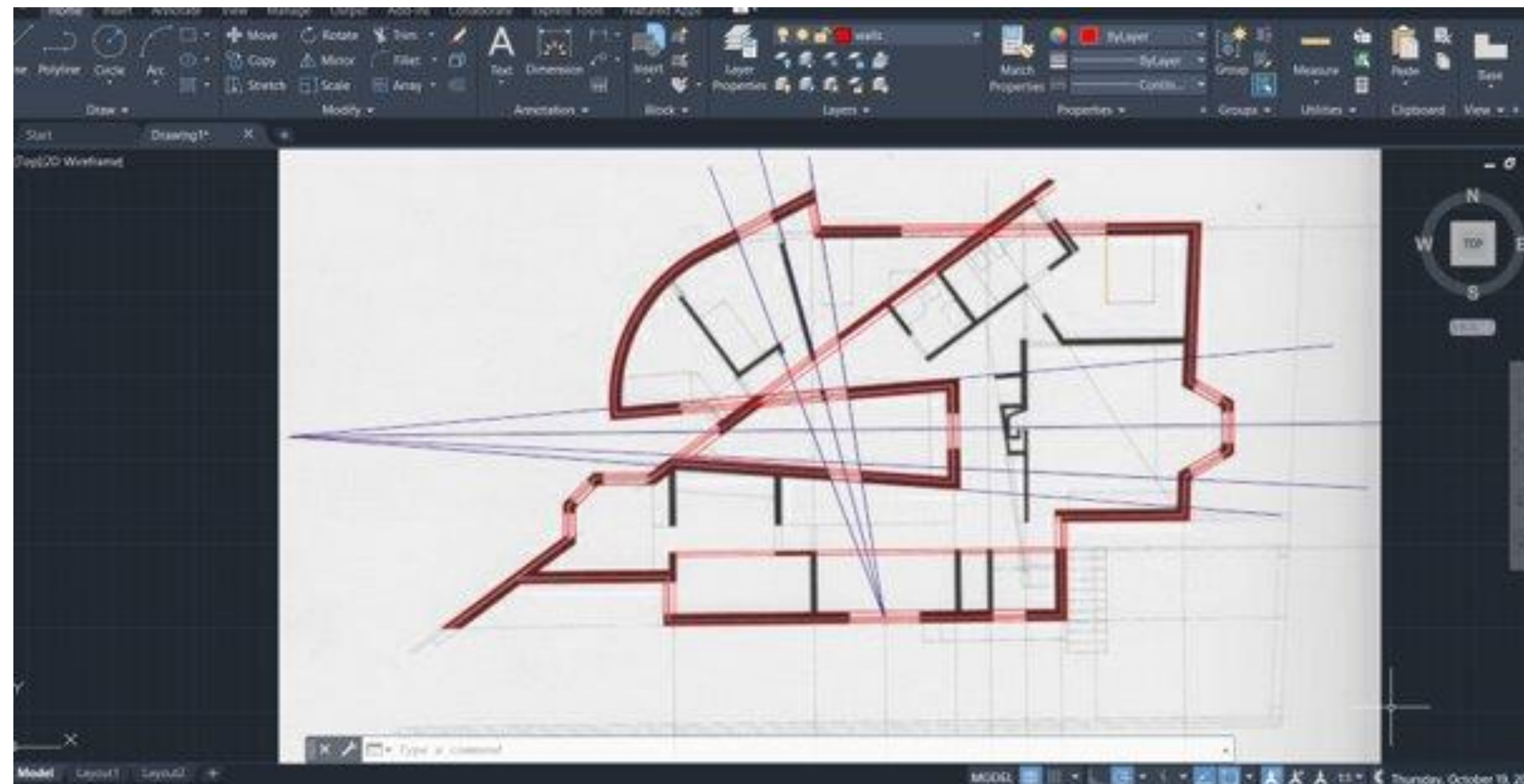

Aula 7 - 13 de Outubro

- Continuação do trabalho 1

Aula 9 - 20 de Outubro

- Continuação do trabalho 1 – promenor do caixilho em madeira

Aula 8 - 19 de Outubro

- Continuação do trabalho 1

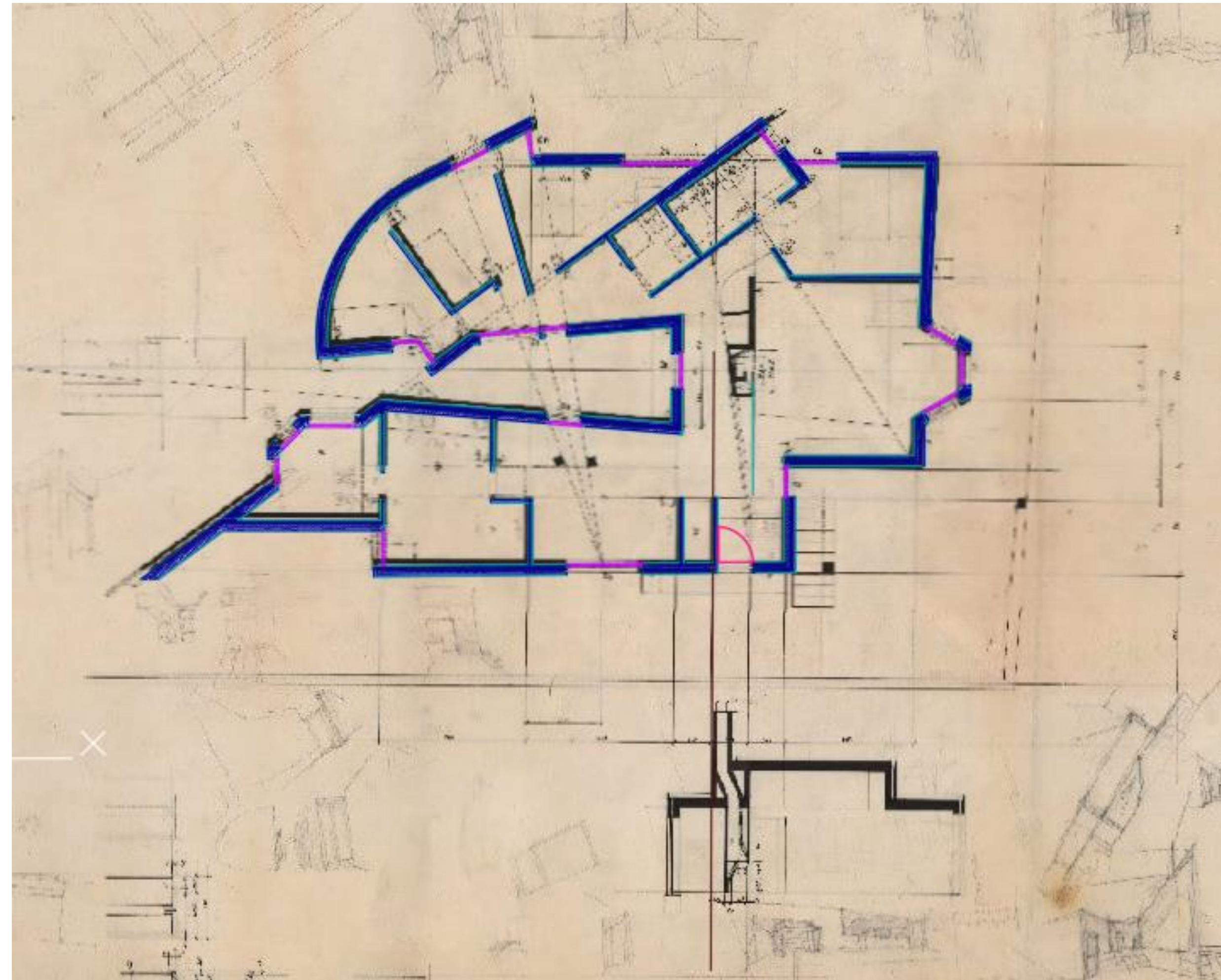

Aula 10 - 28 de setembro

- Desenho do corte

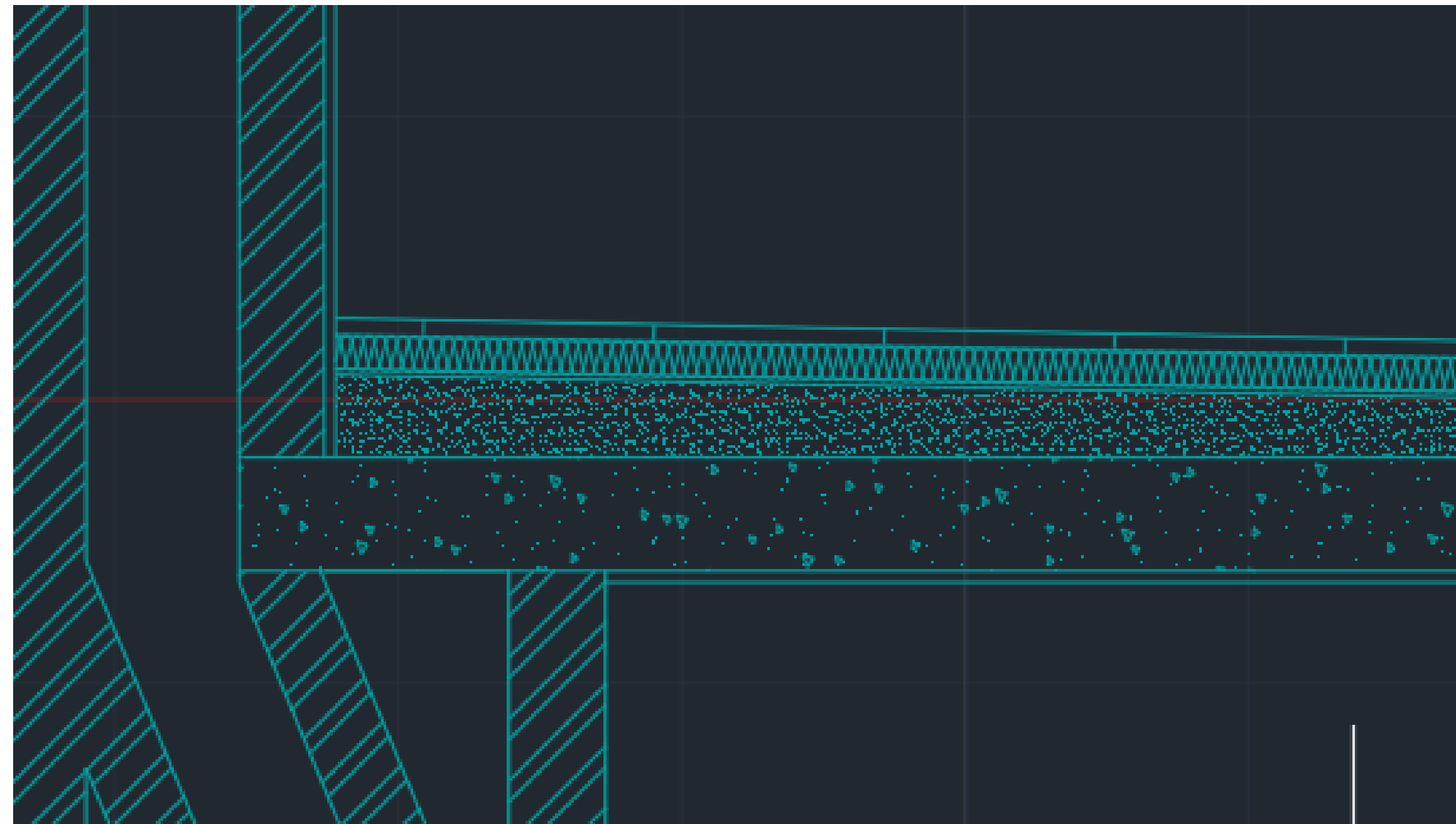
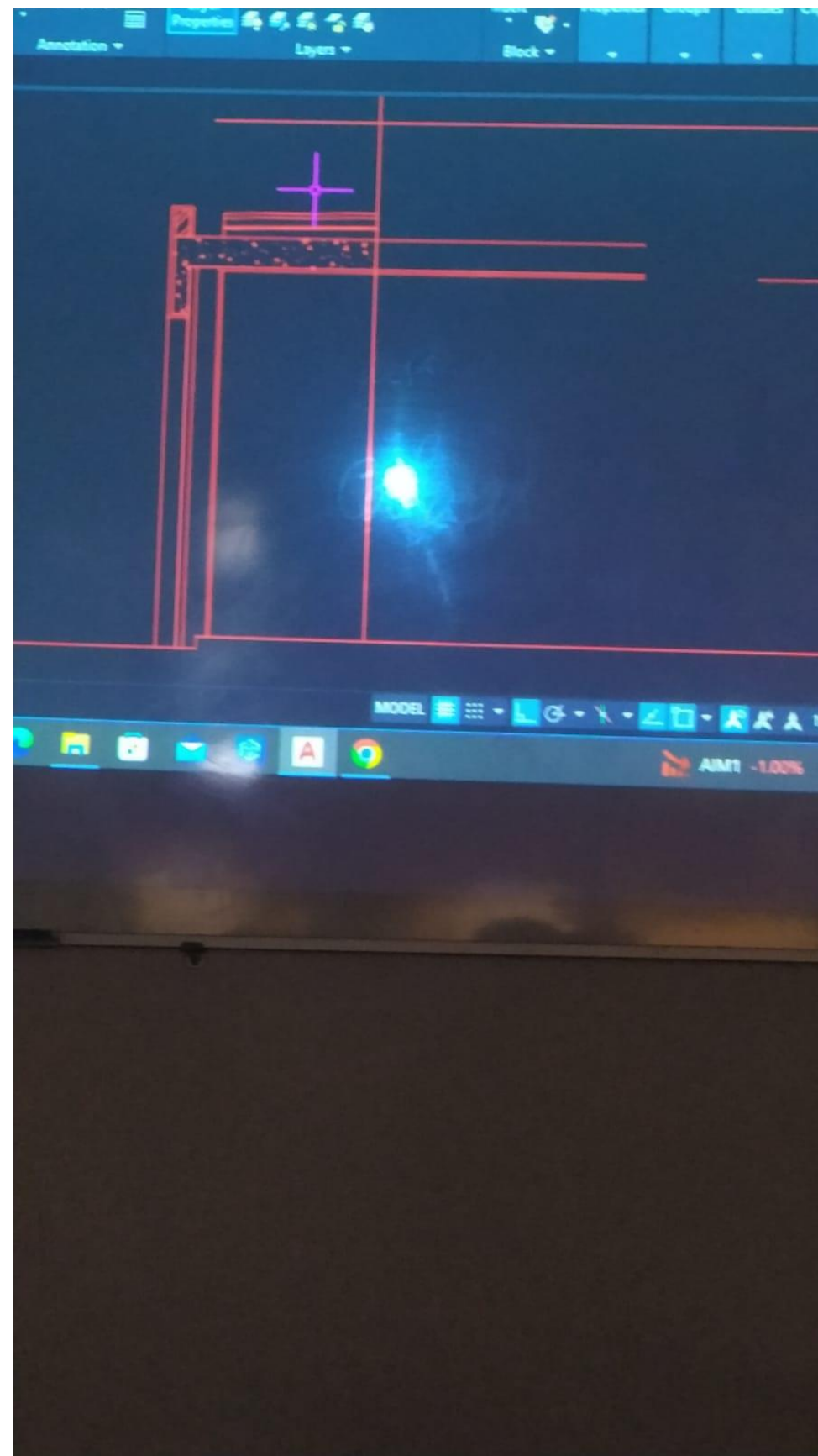

Aula 11 - 27 de Outubro

- Continuação da construção do corte

Aula 12 - 2 de Novembro

- Introdução ao 3D no Autocad

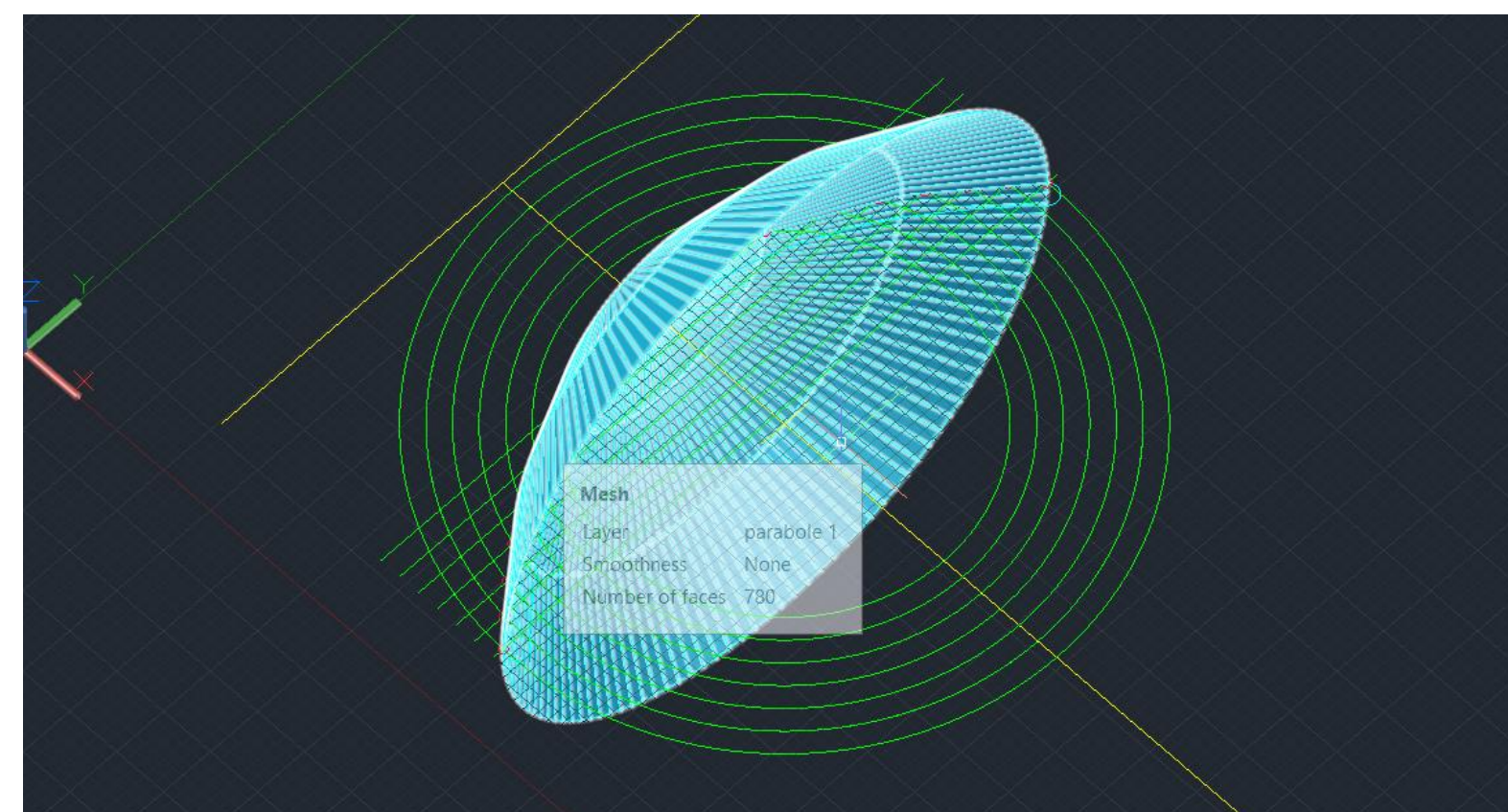
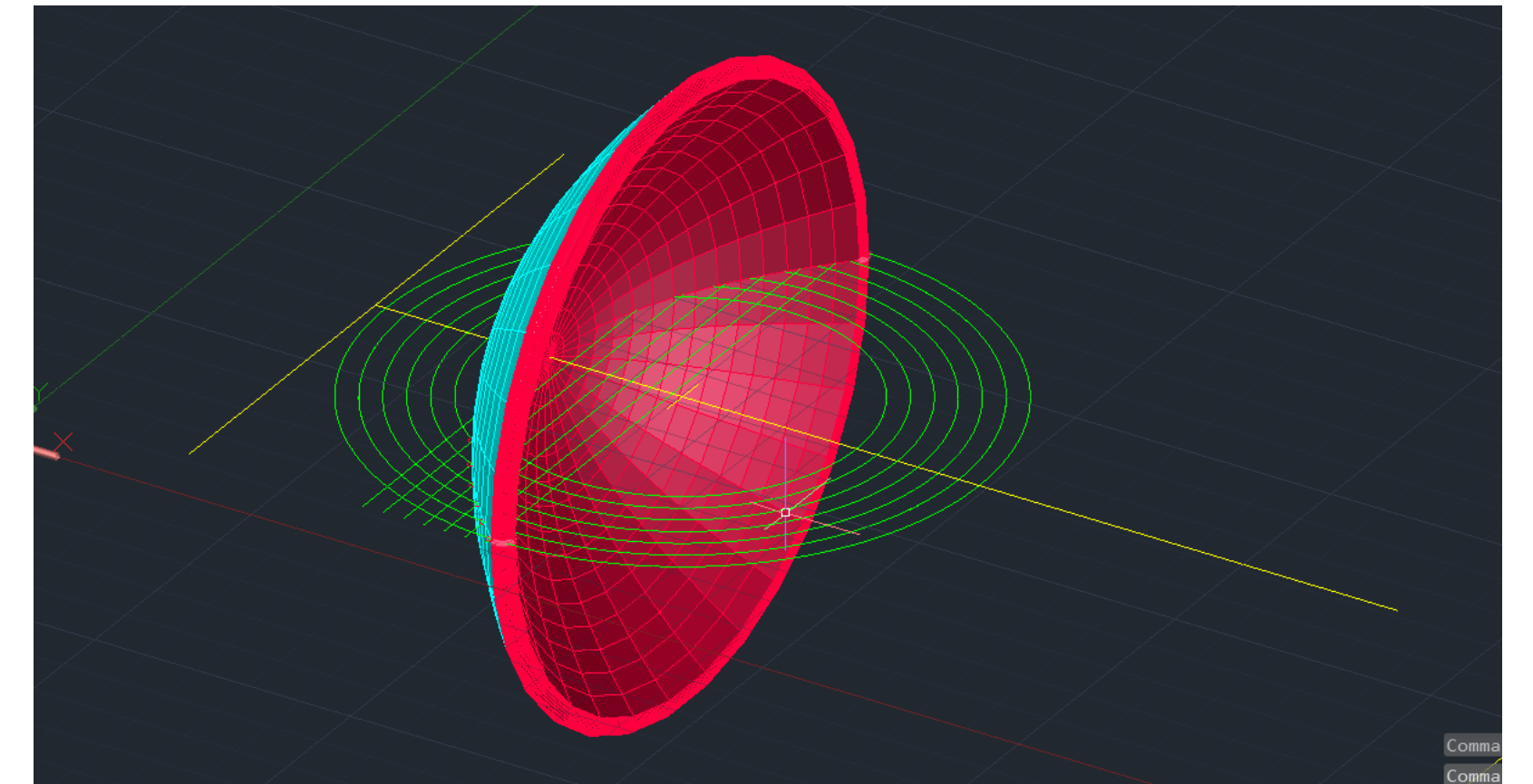
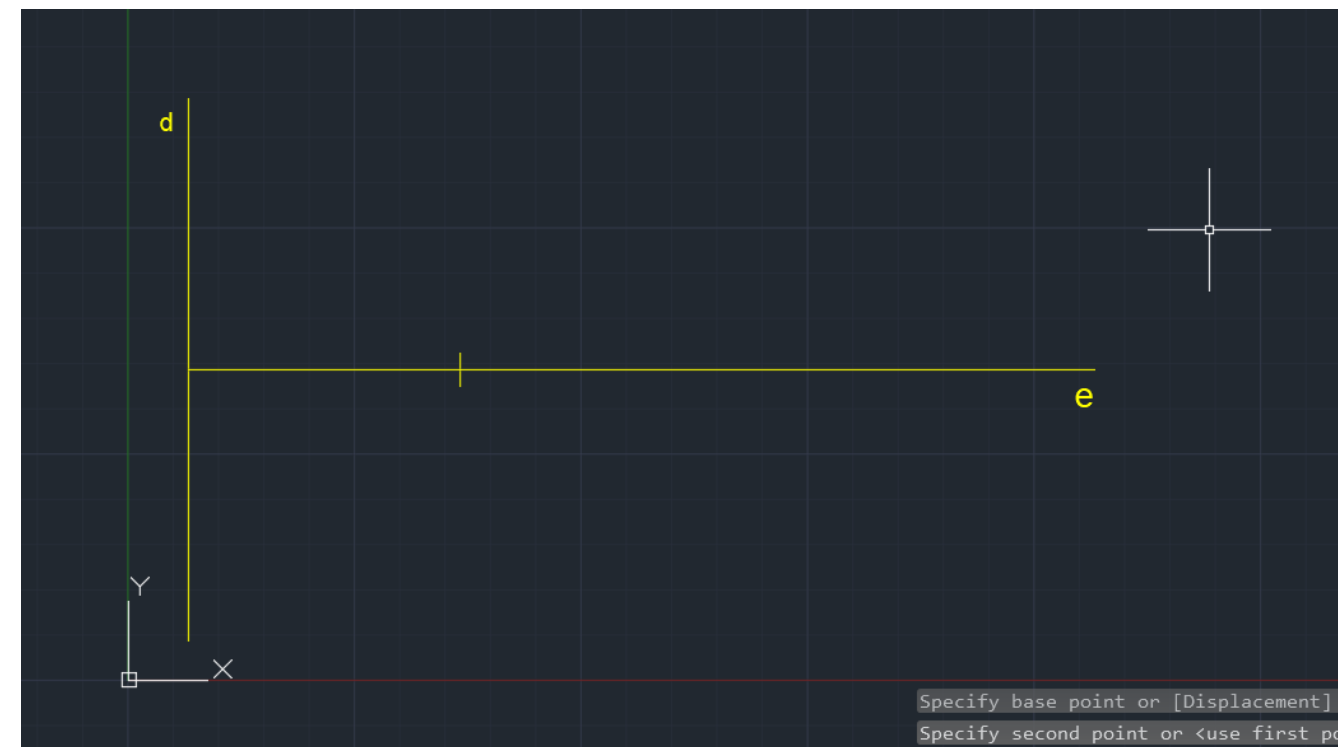

Aula 13 - 3 de Novembro

- Introdução do exercício 2

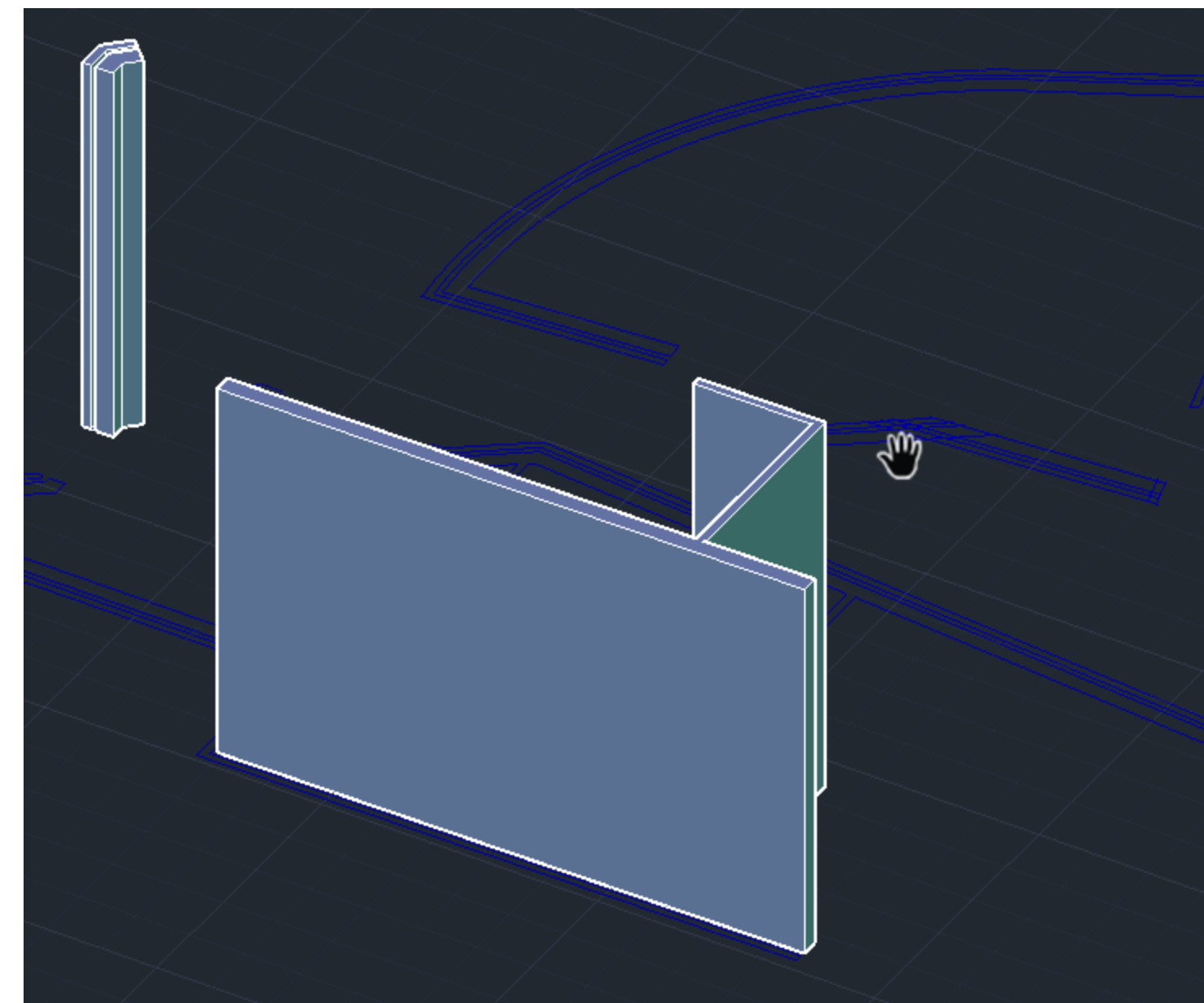
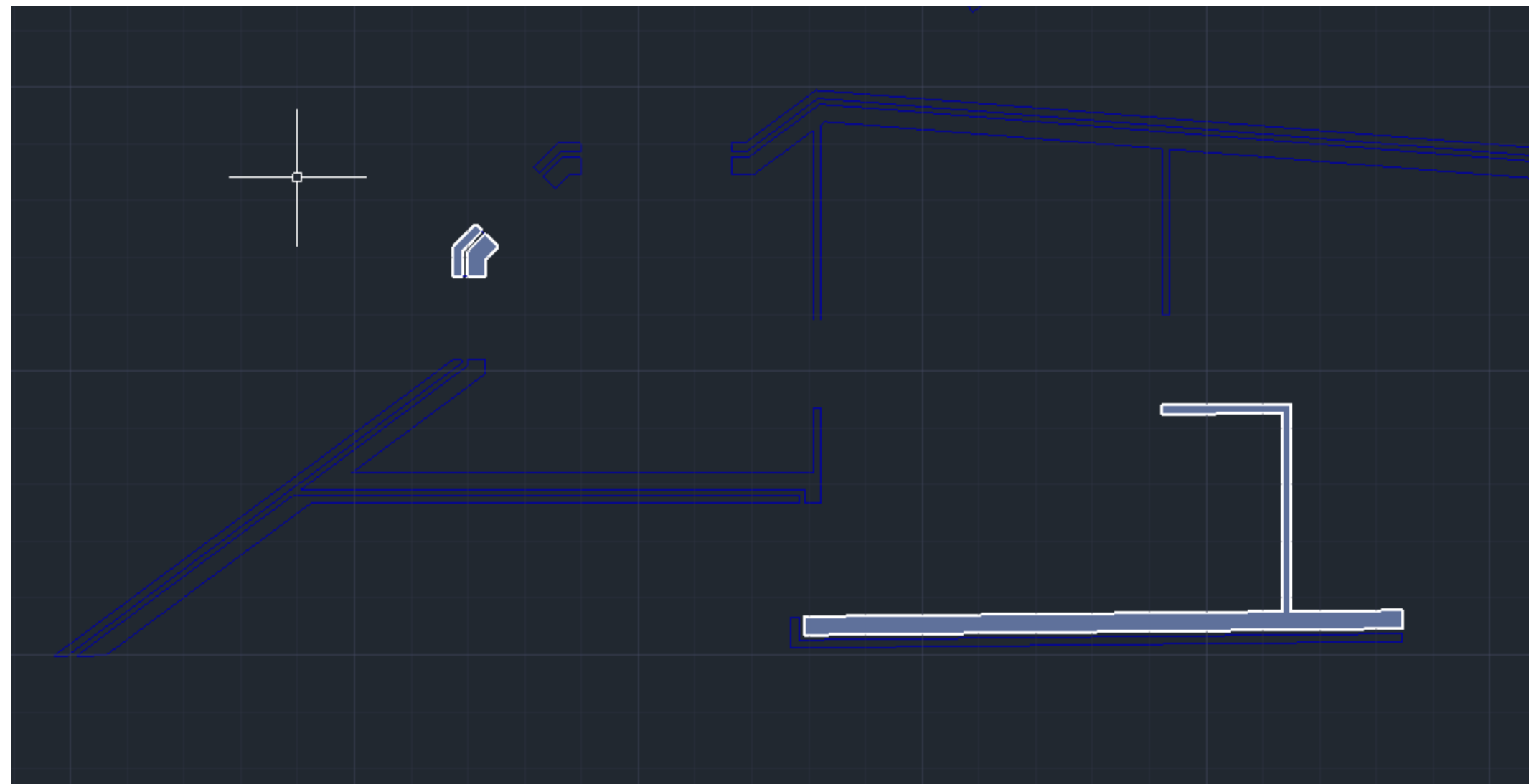

Aula 14 - 9 de Novembro

- Modelação dos sólidos platónicos no Autocad

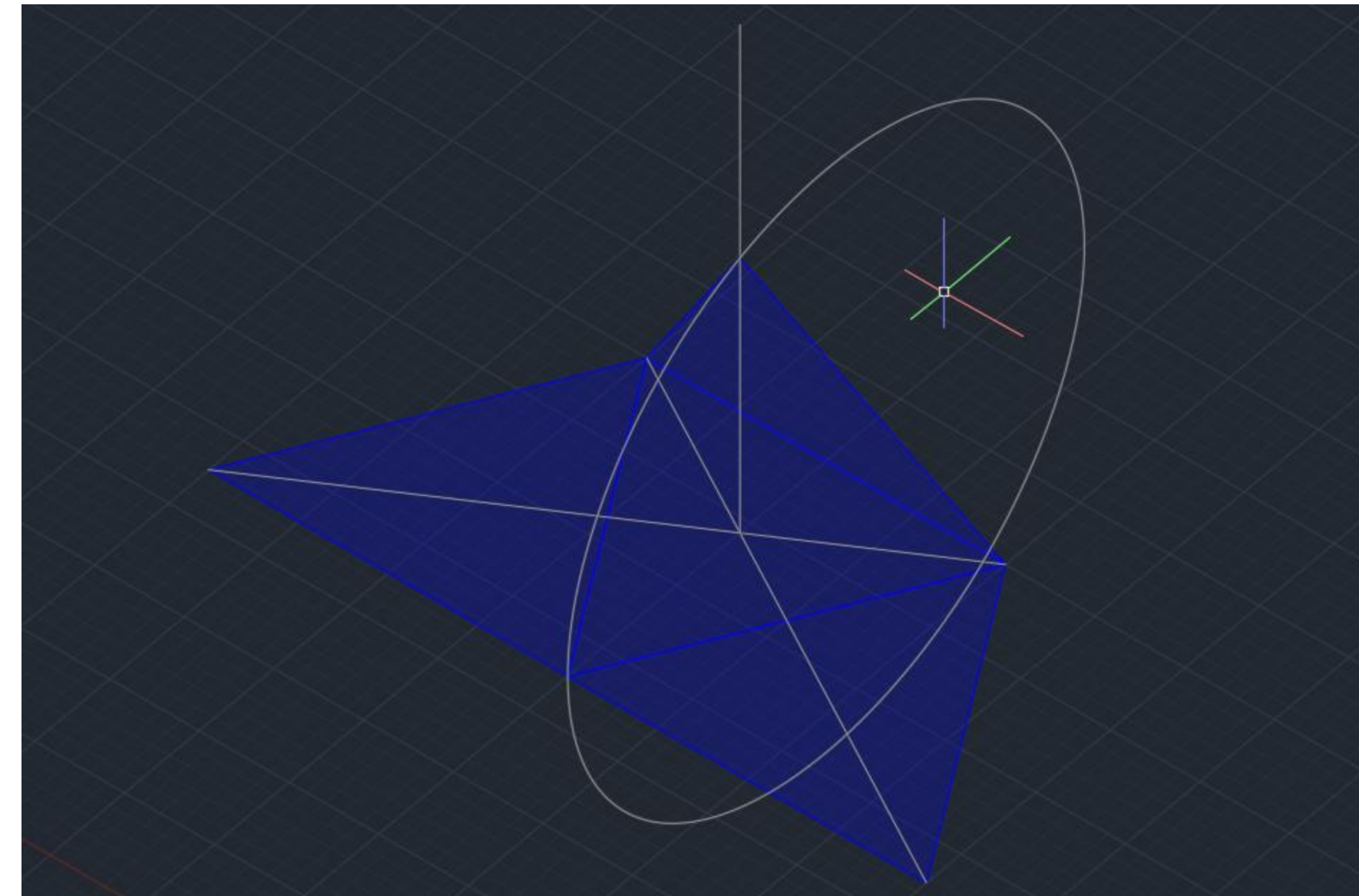
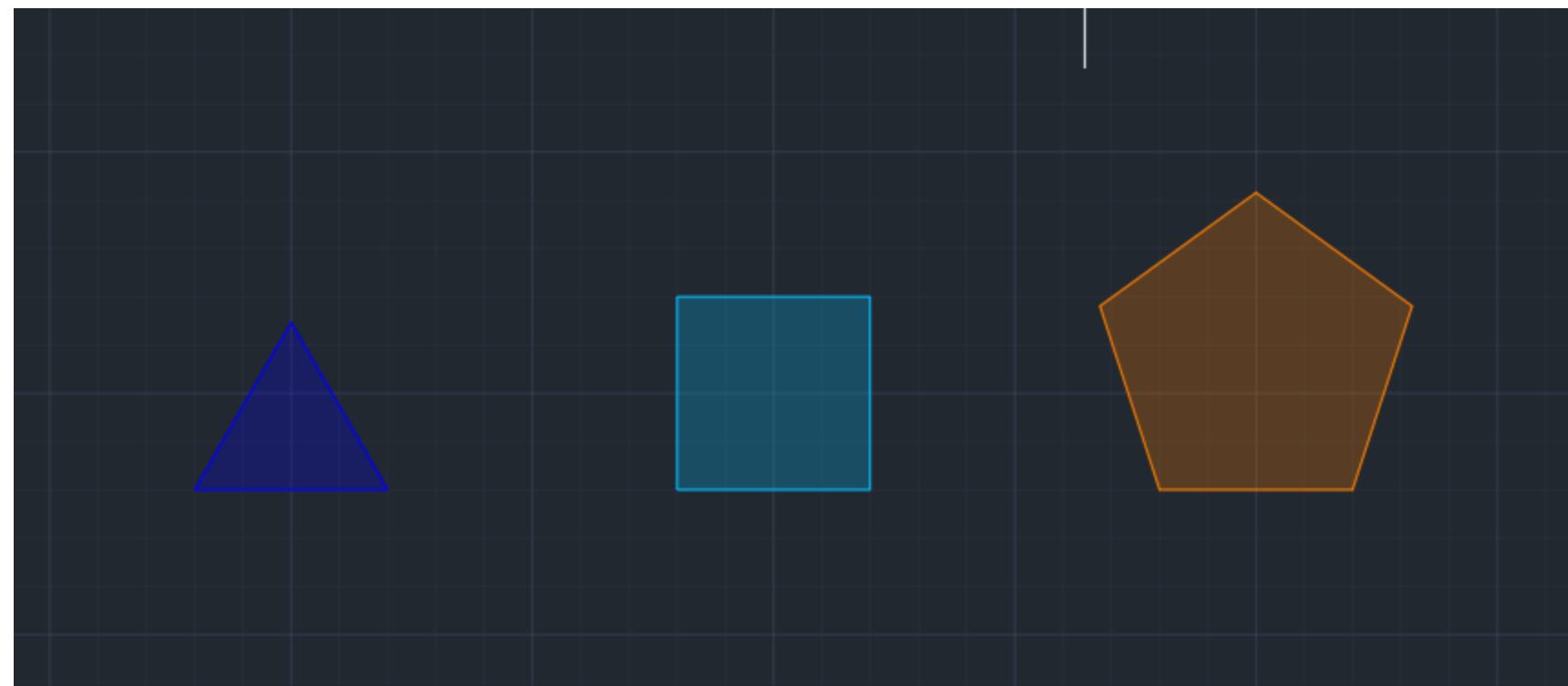

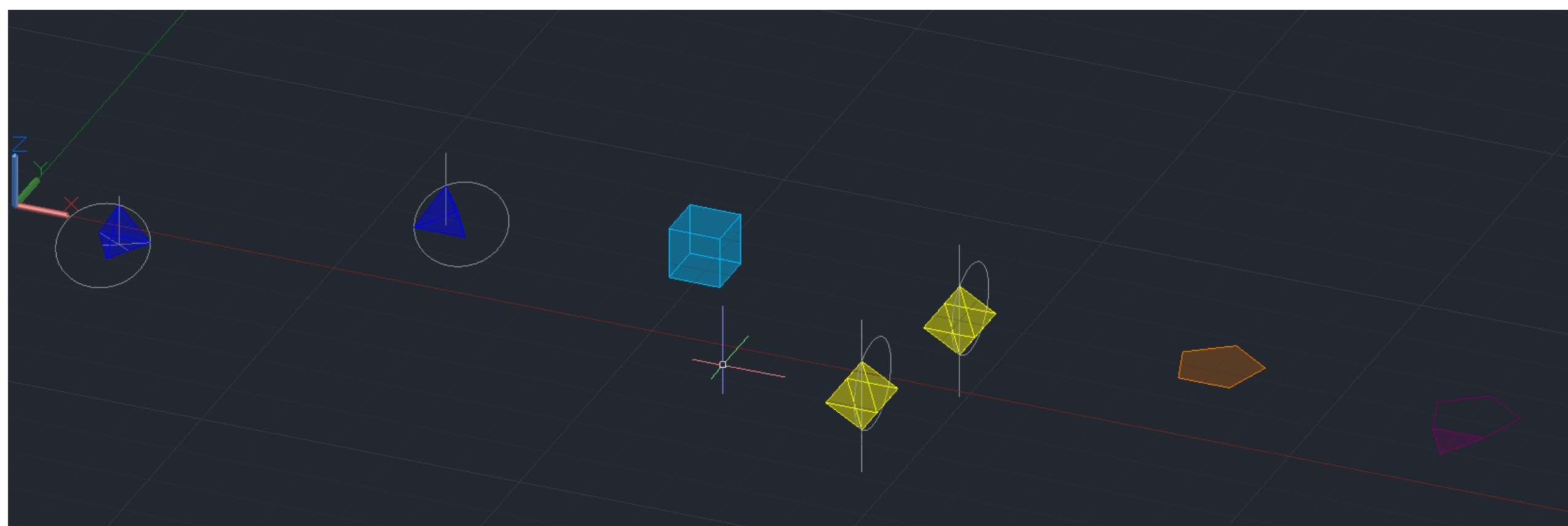
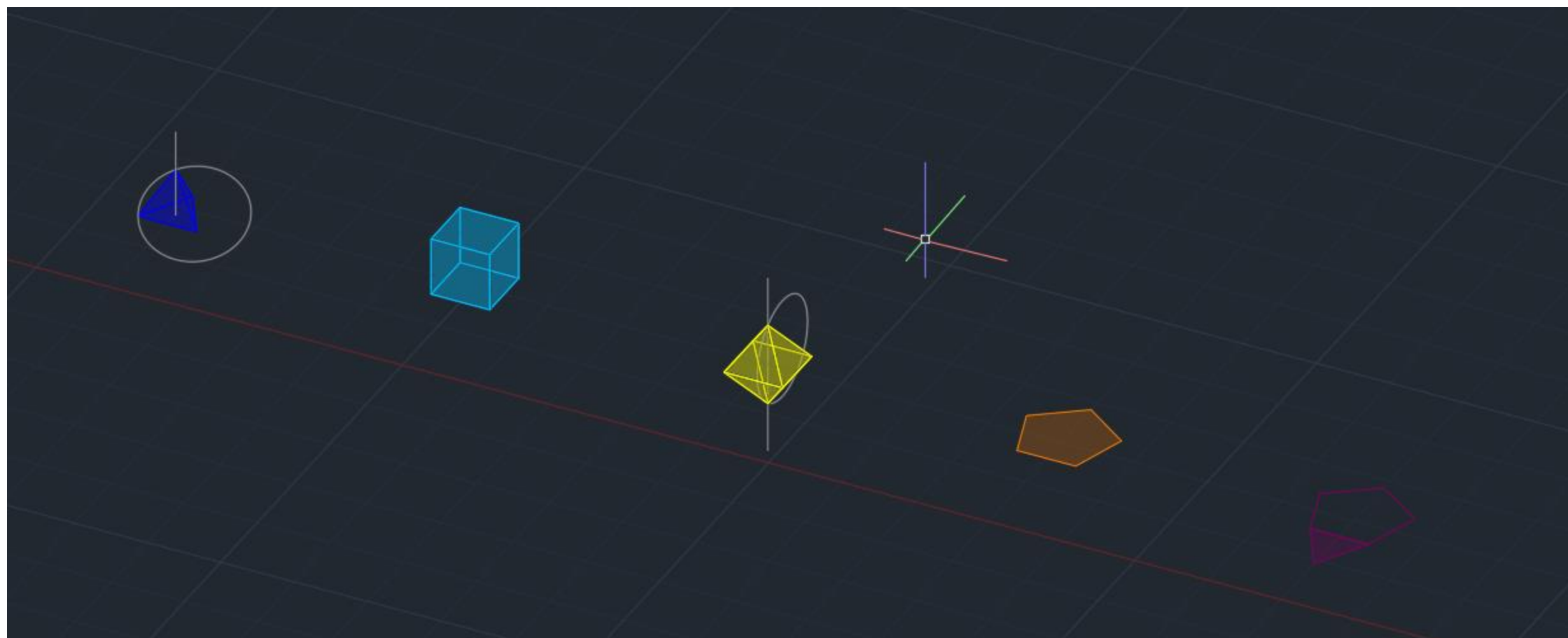

Aula 15 - 10 de novembro

- Finalização e preparação para a entrega do Exercício 1

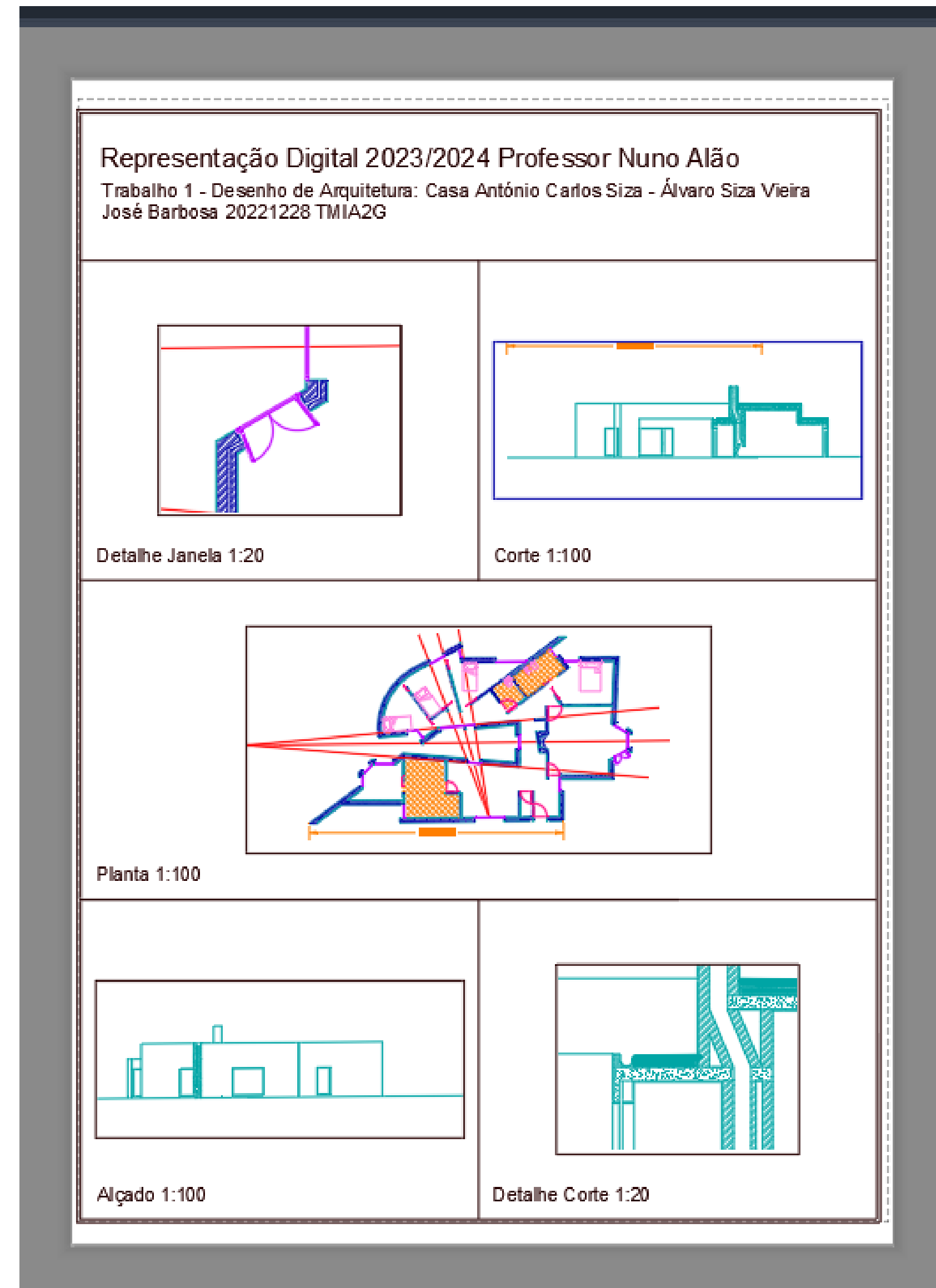
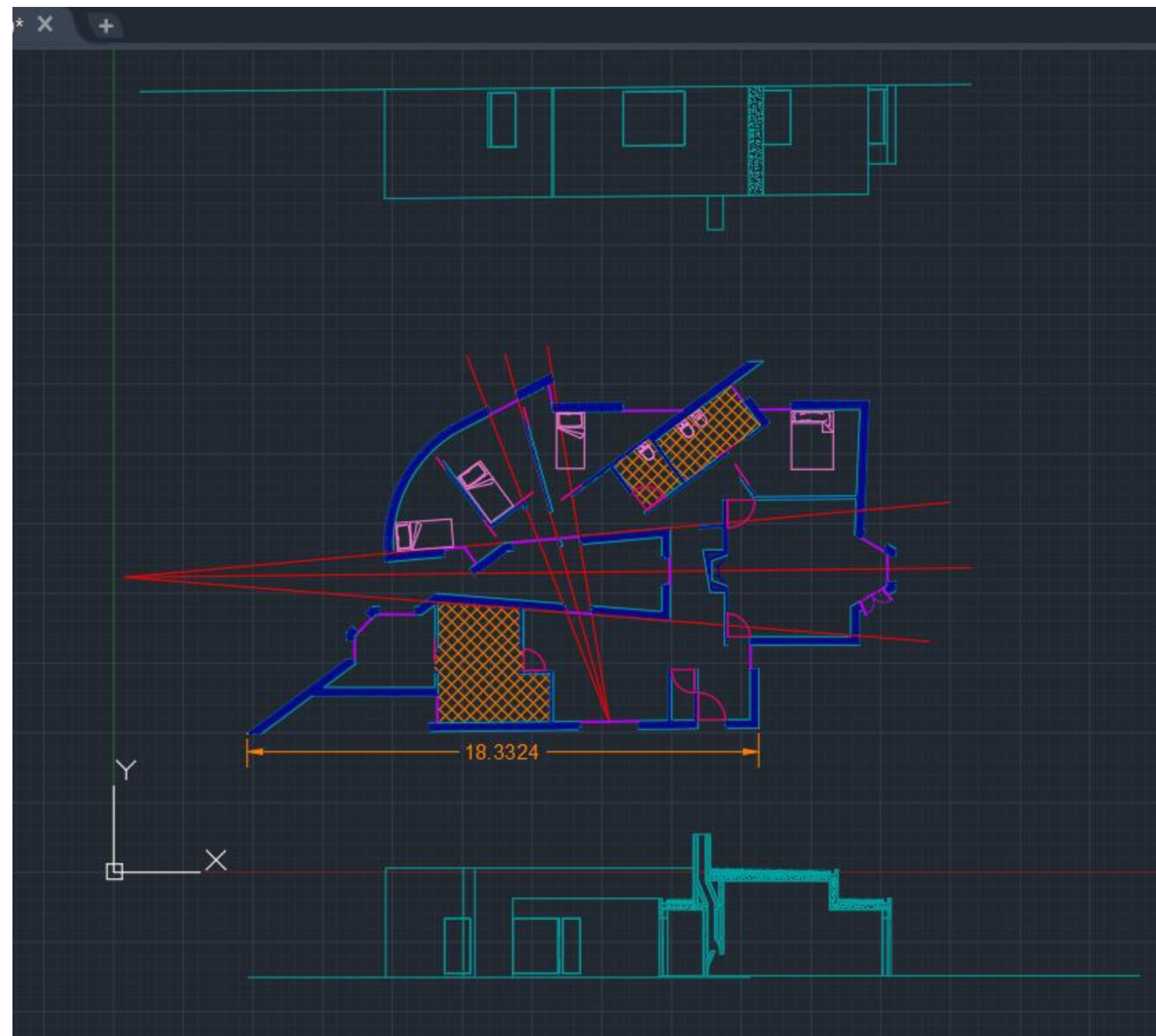

Aula 16 - 16 de Novembro

- 2ª aula de modelação dos sólidos platónicos

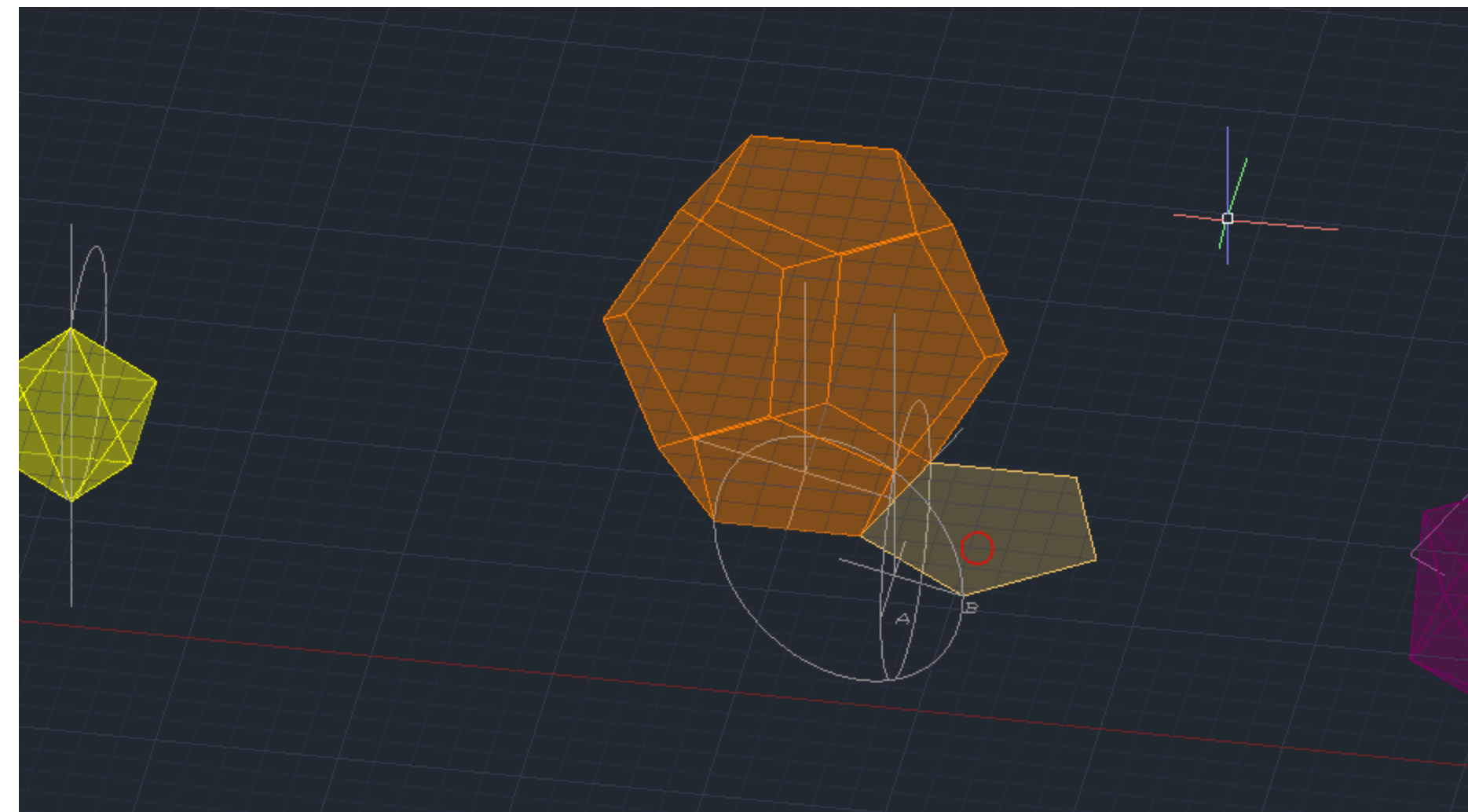
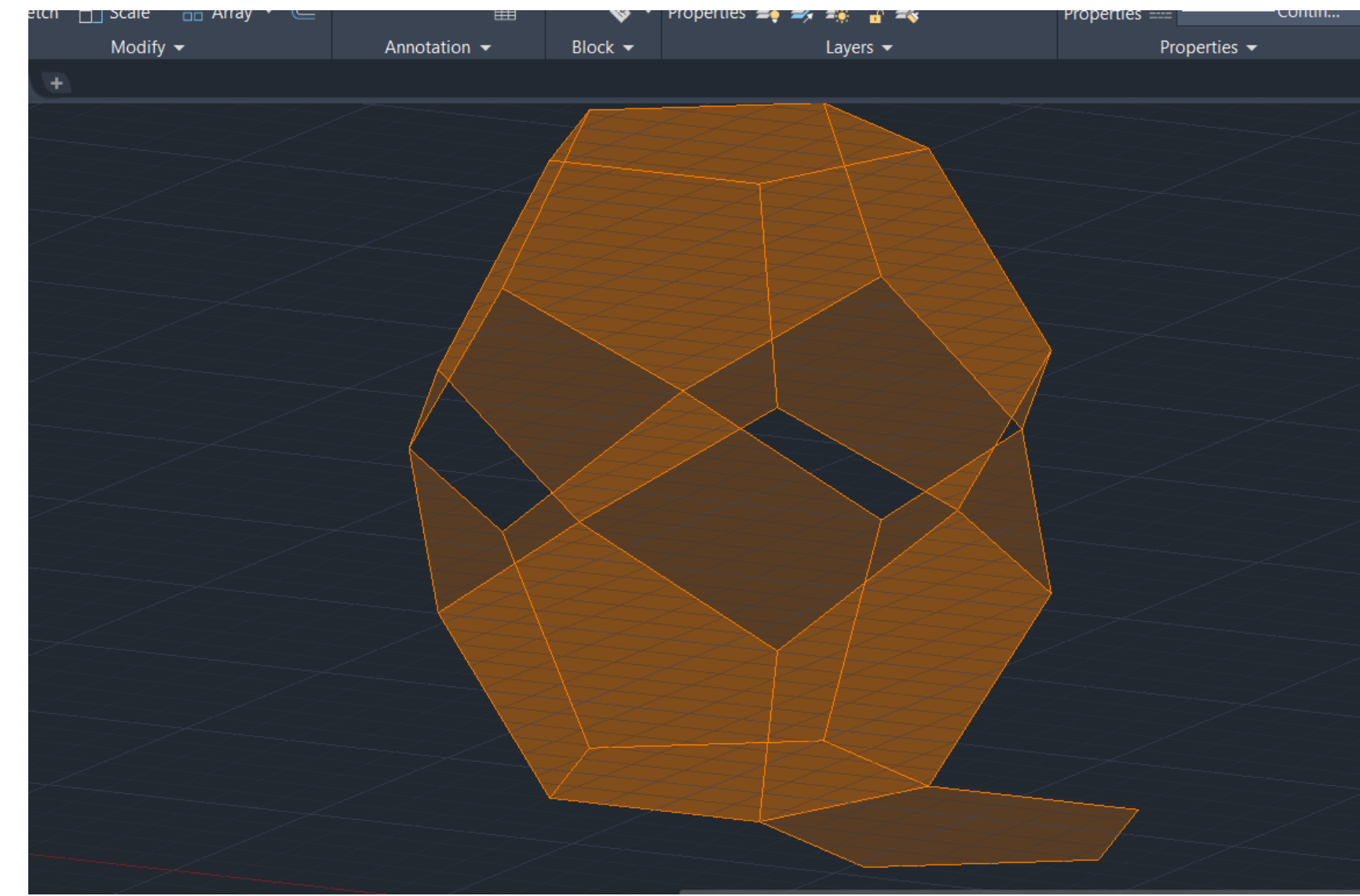
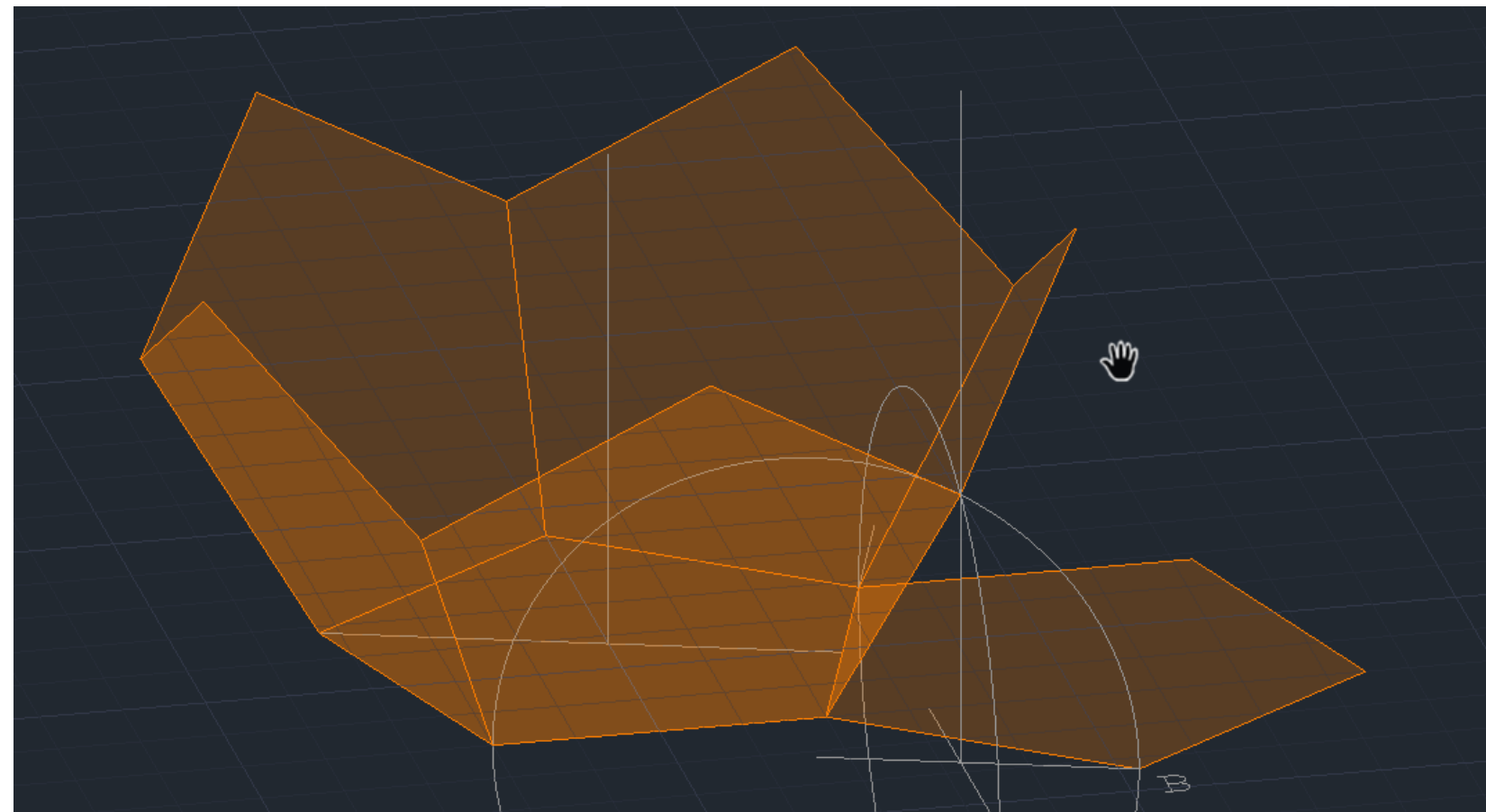

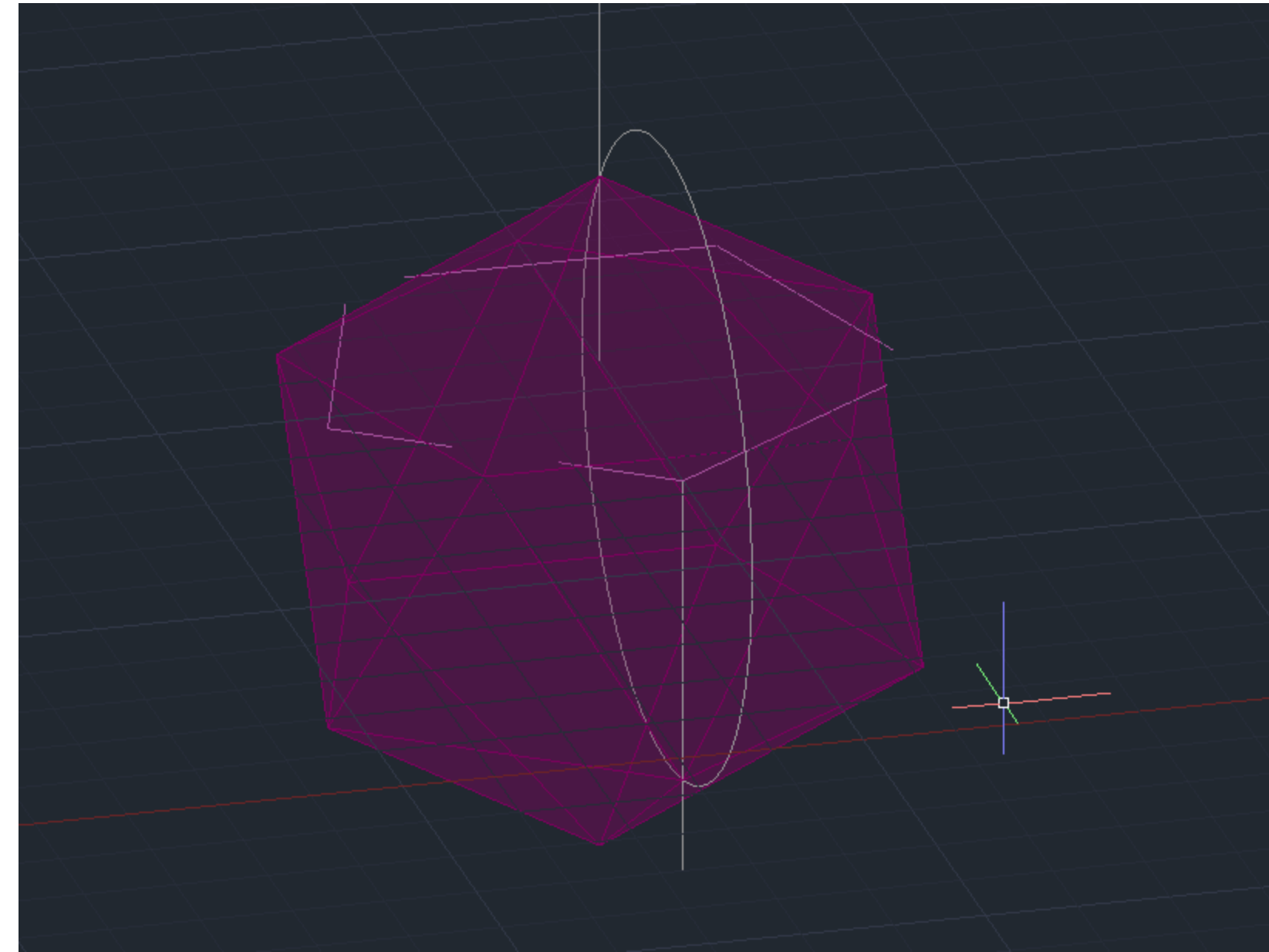
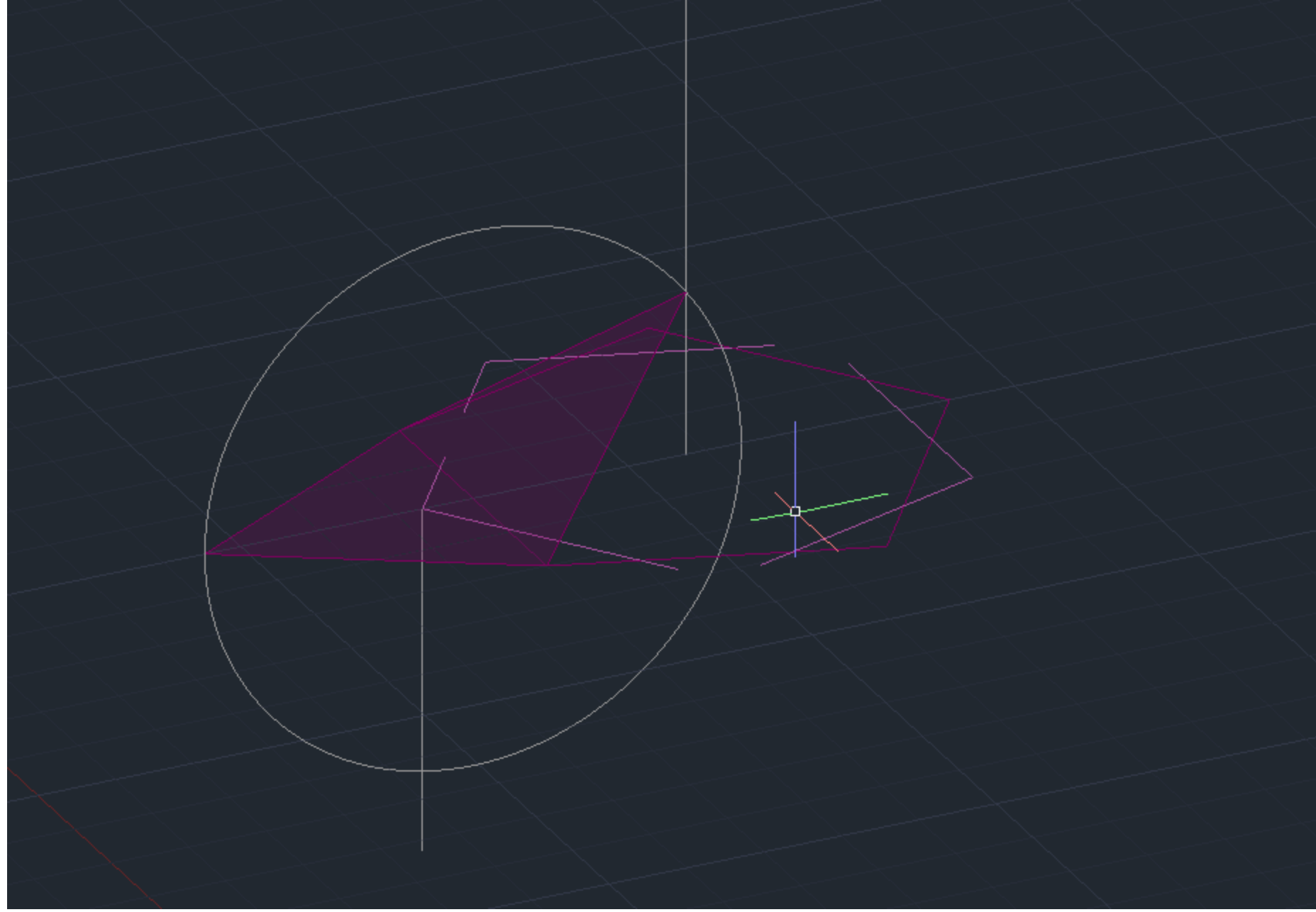

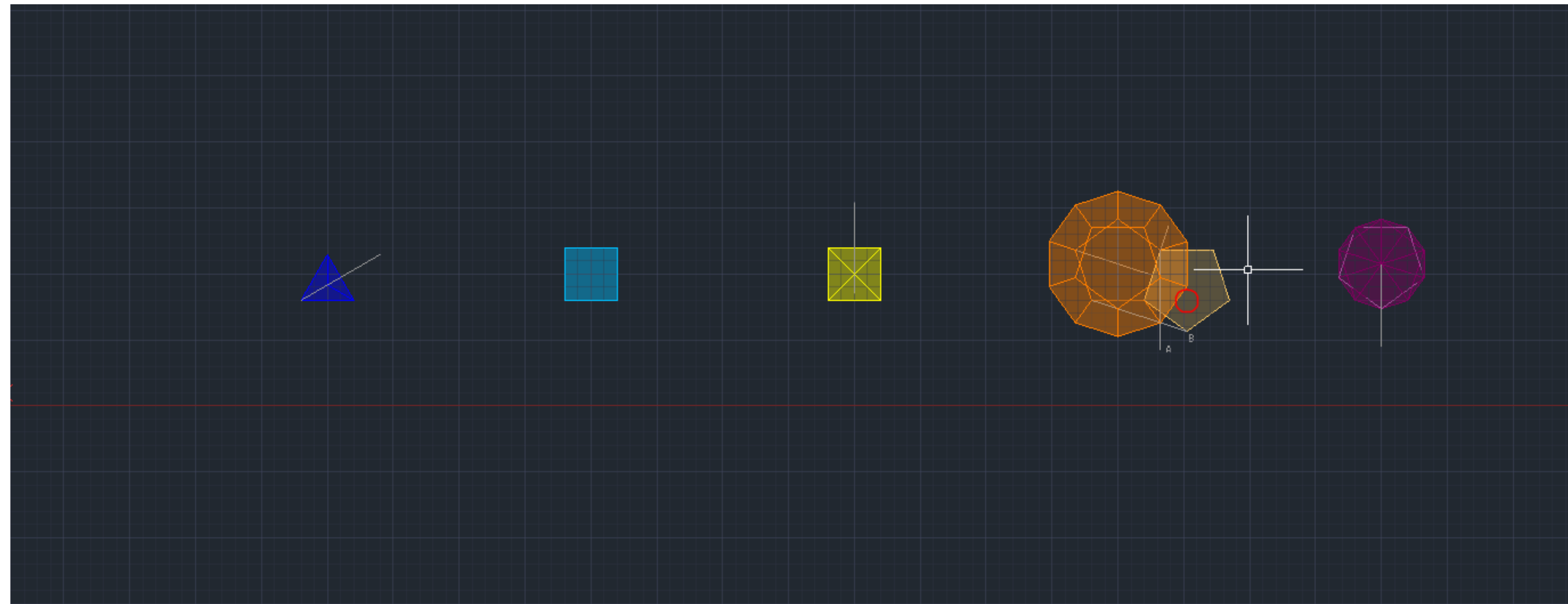
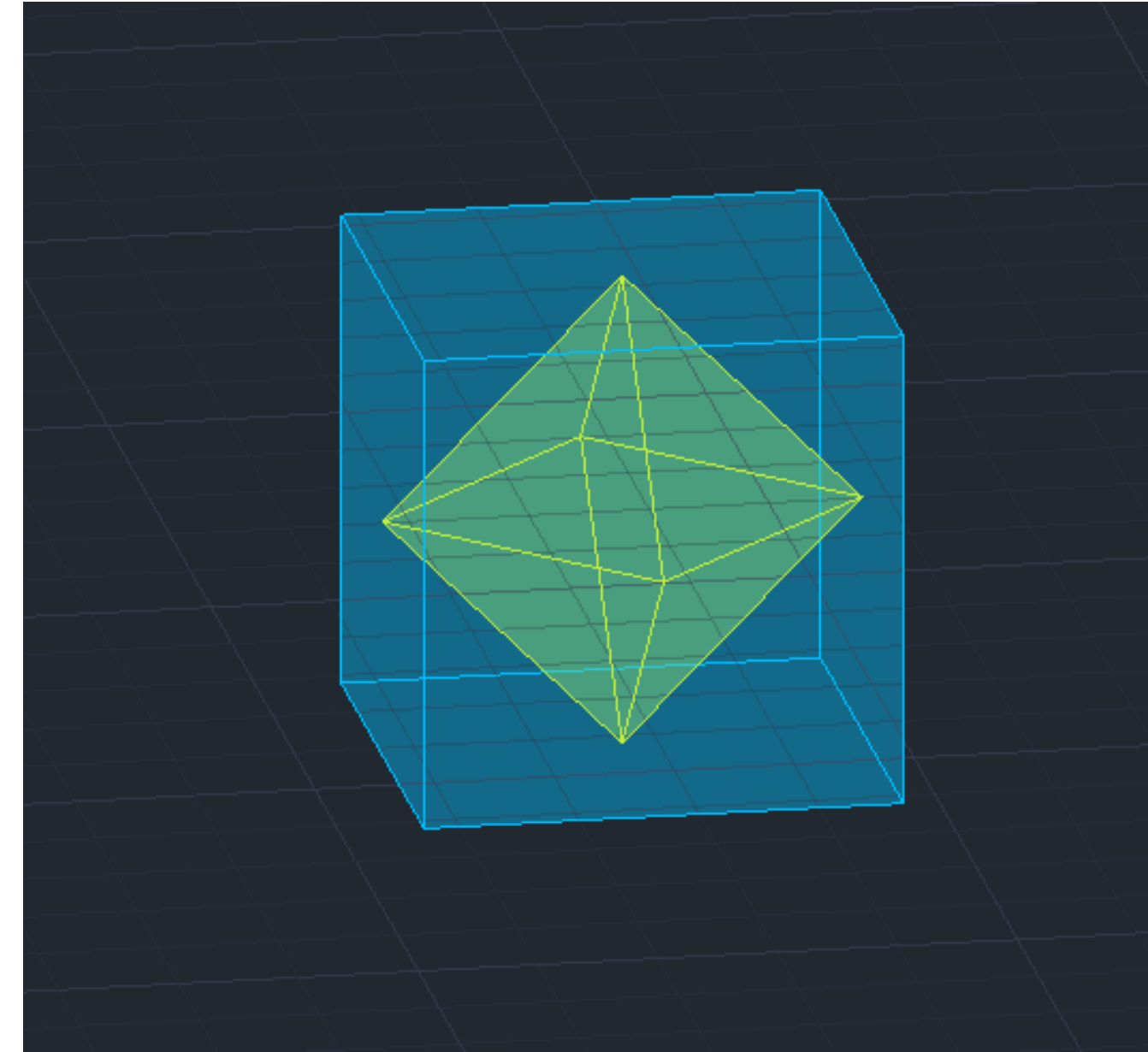
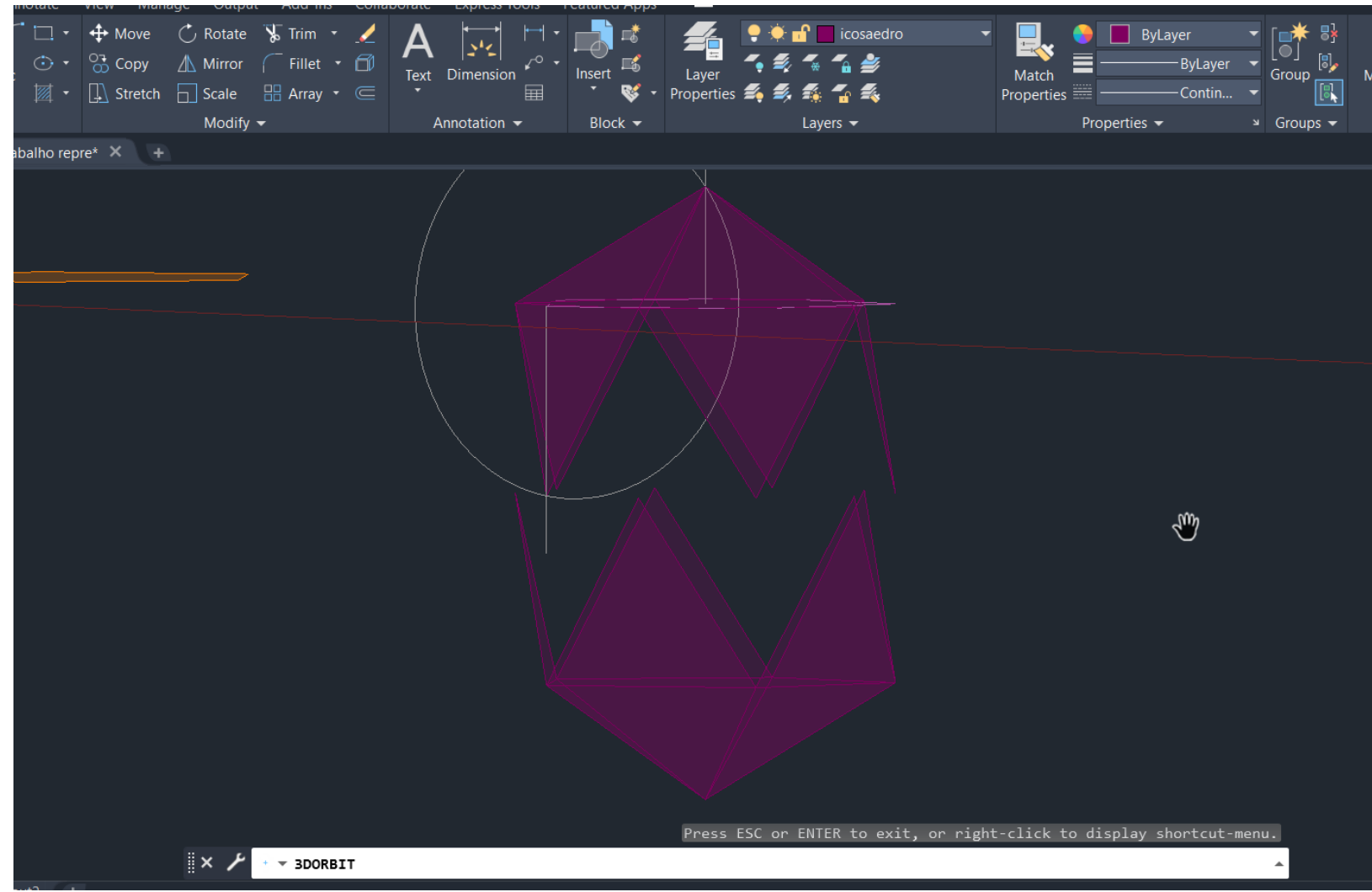

Aula 17 - 17 de Novembro

Estudo das relações Duais entre os sólidos platônicos

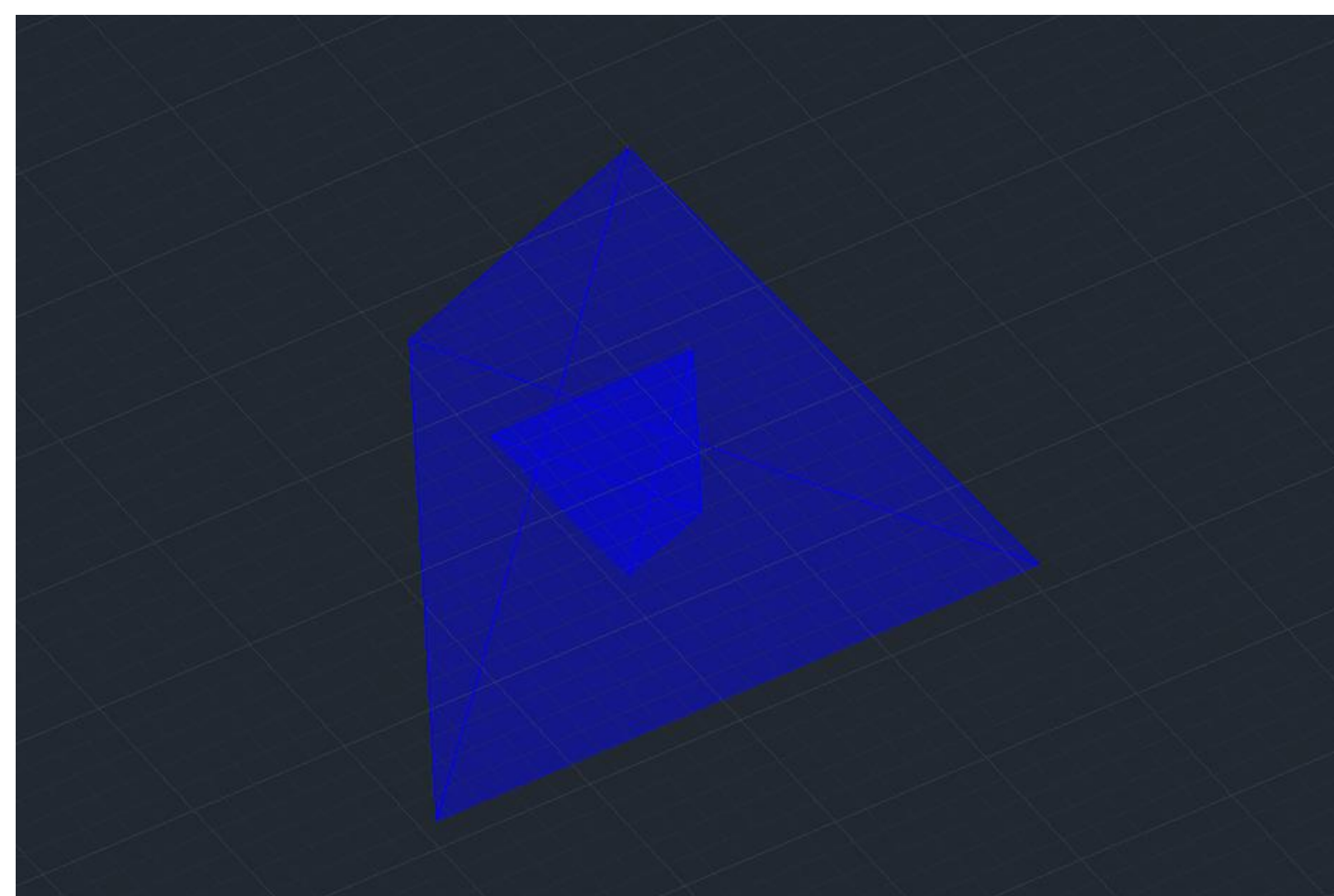
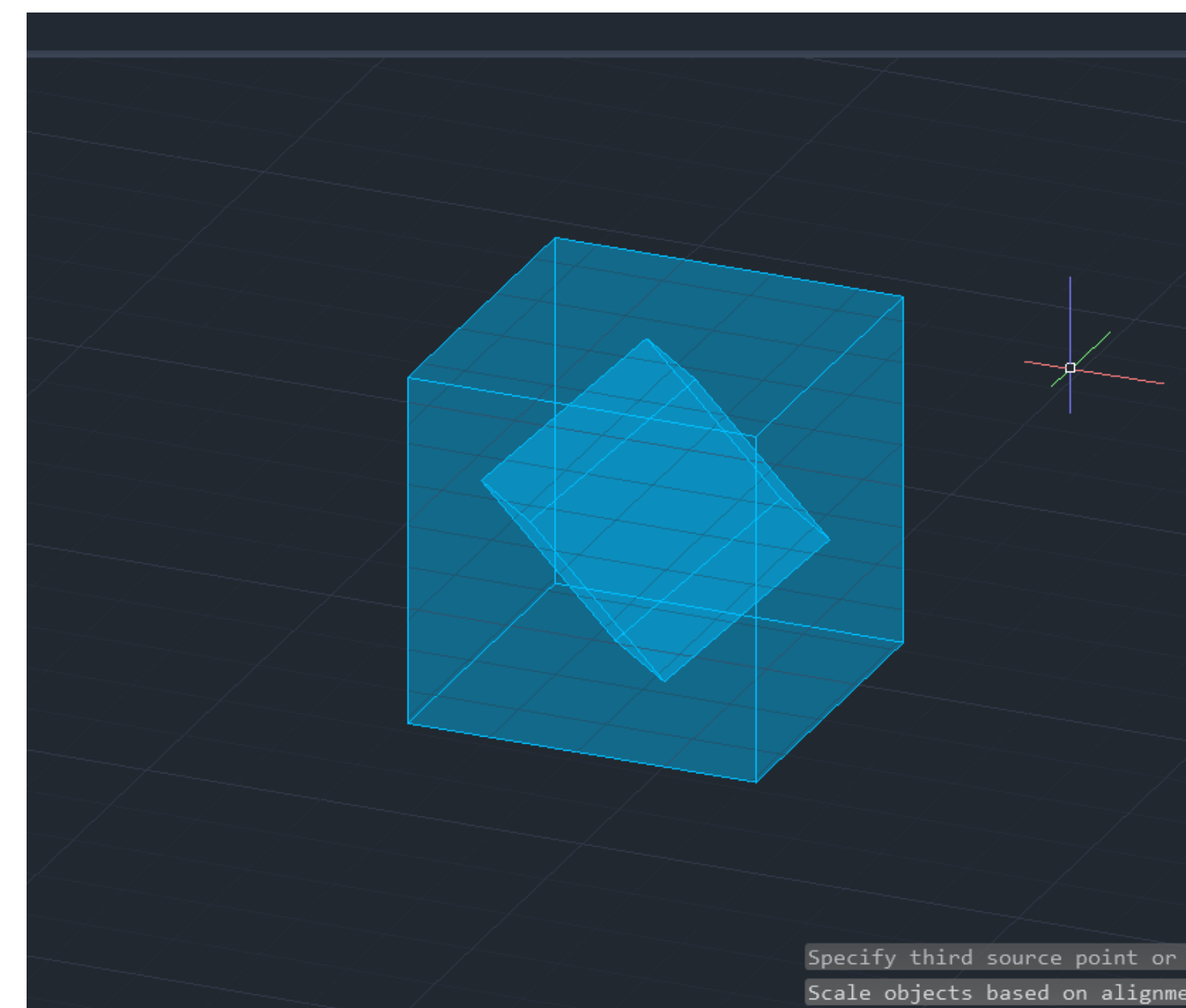
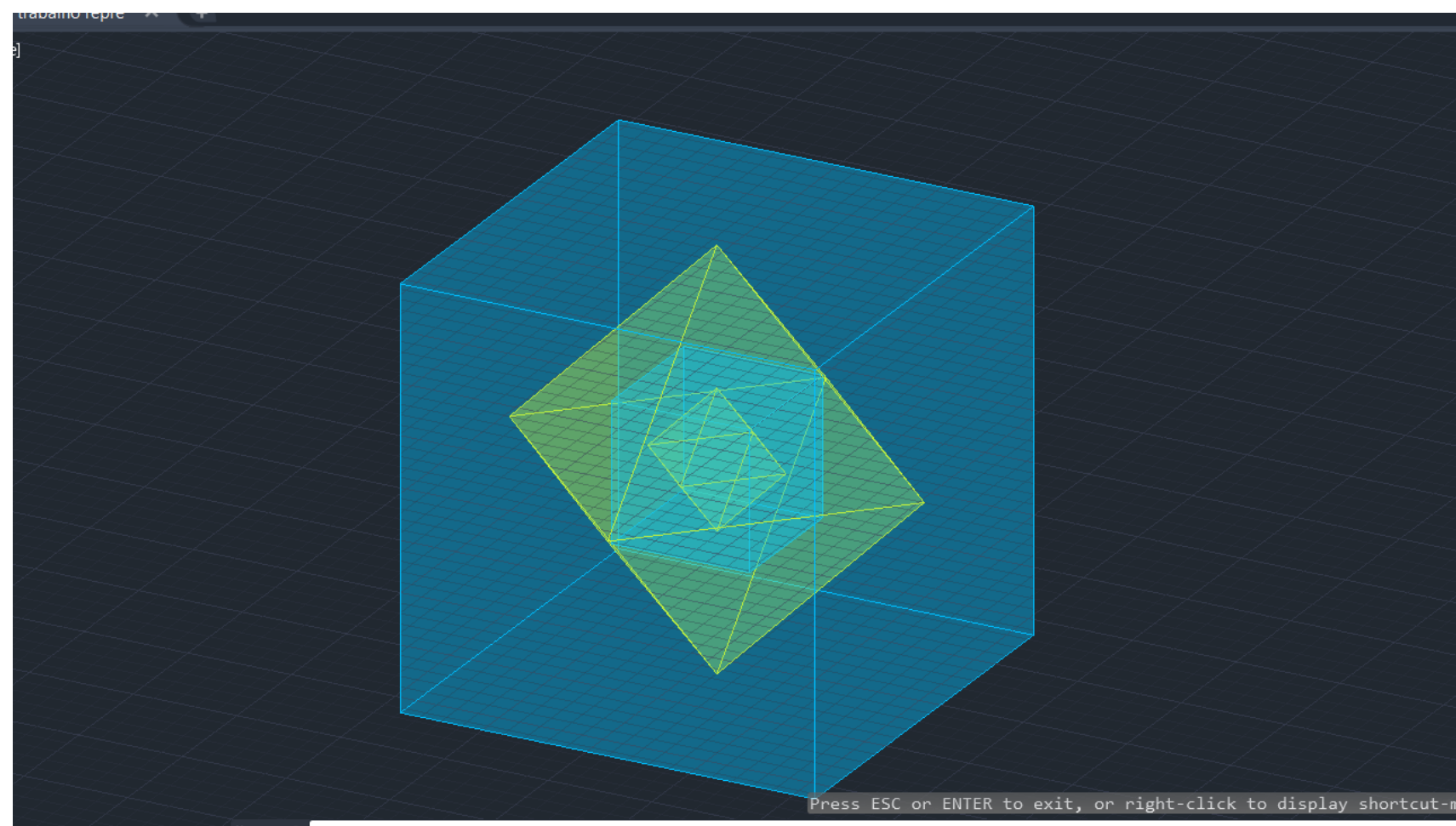

Aula 18 - 23 de Novembro

- Aula de aprofundação do tema de modelação 3d no Autocad

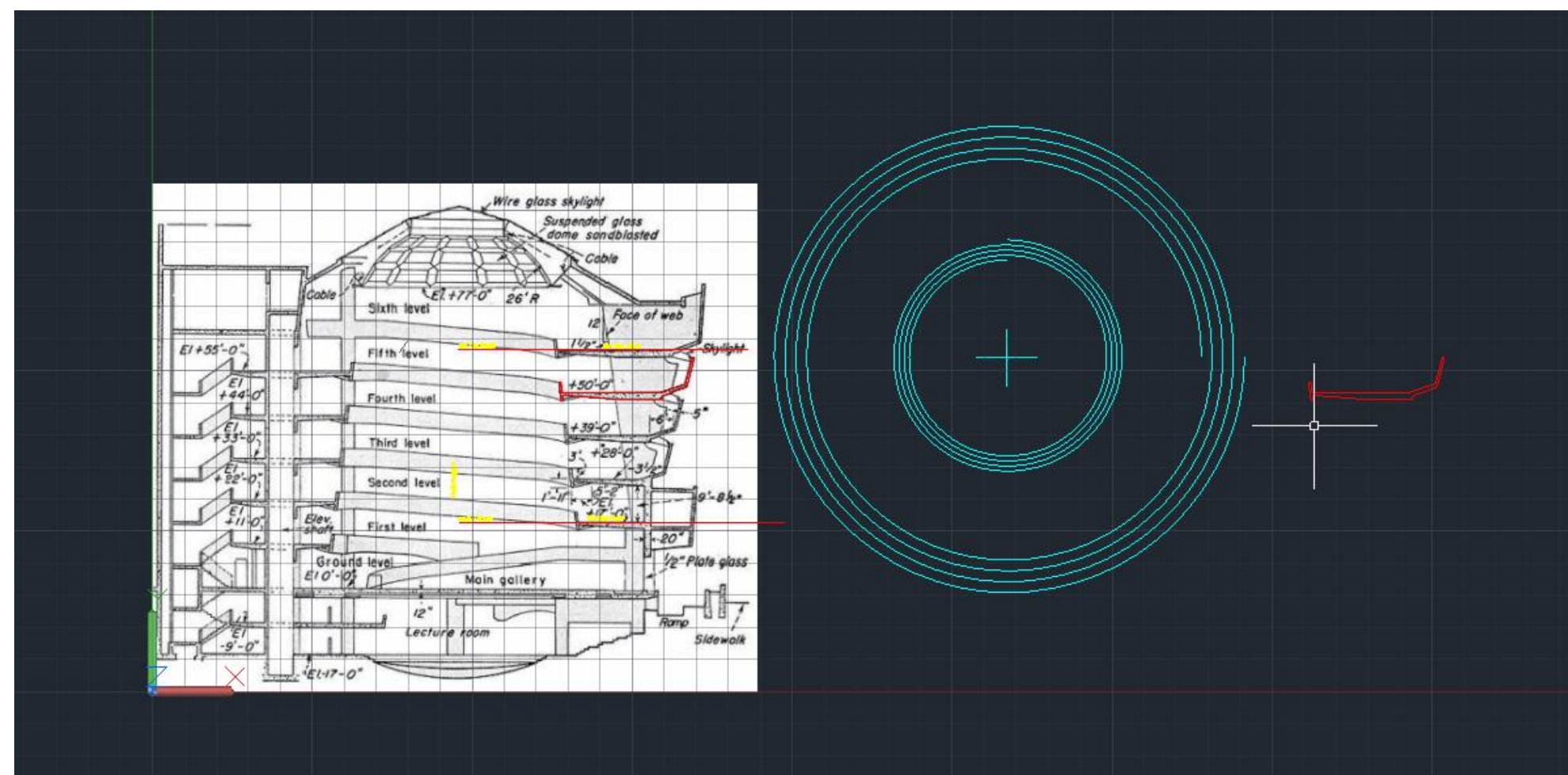
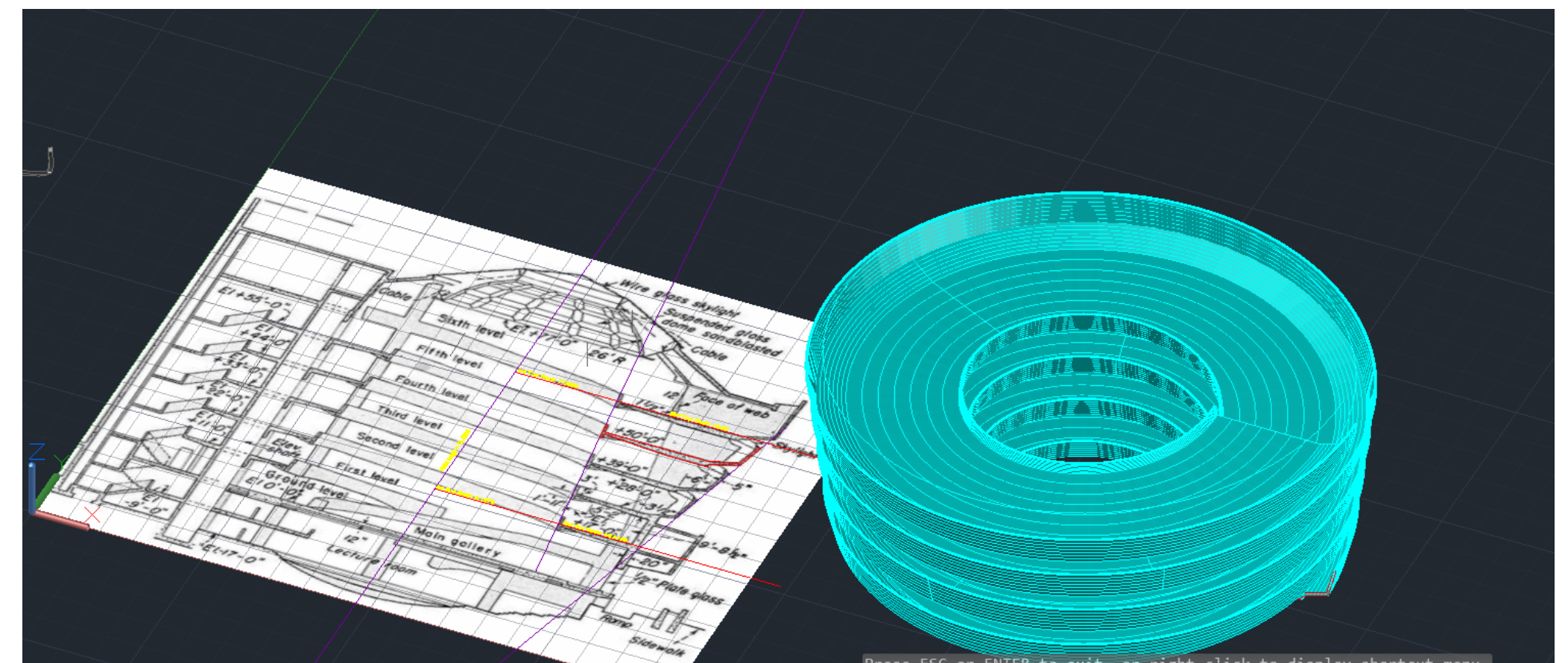
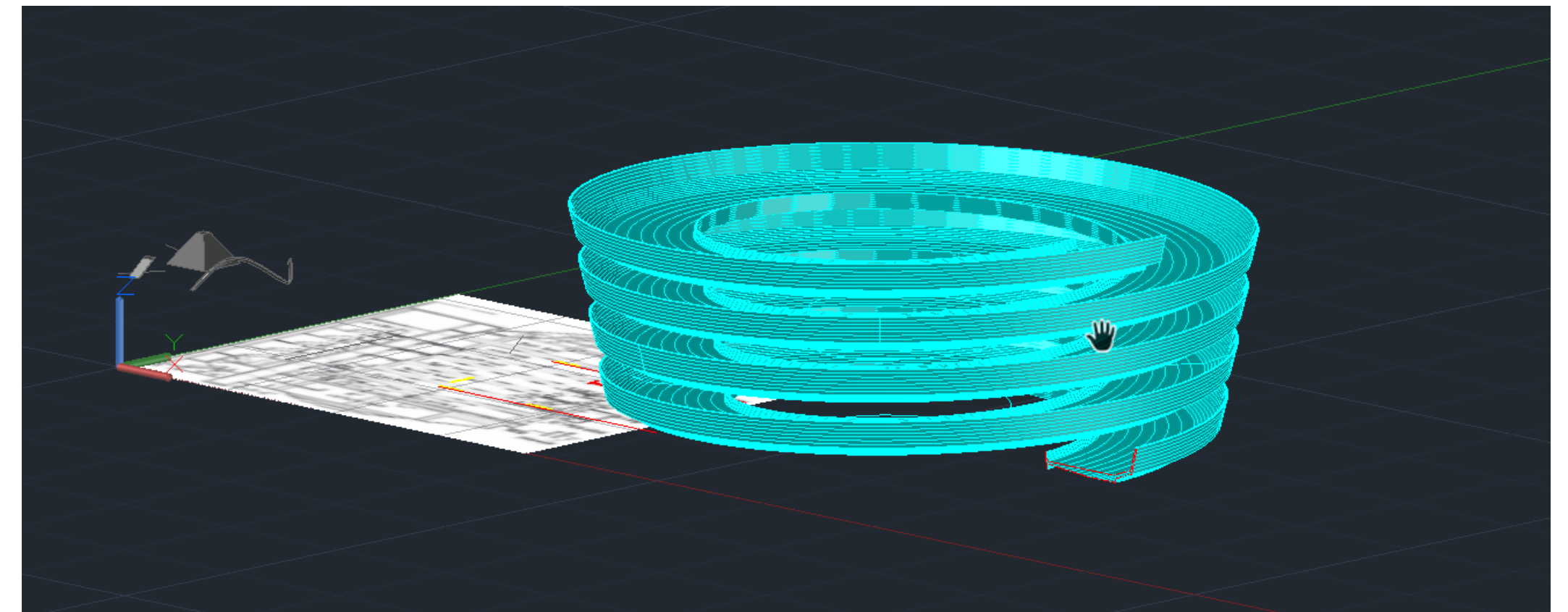

Aula 19 - 24 de Novembro

- Mais exemplos de modelação 3d no Autocad

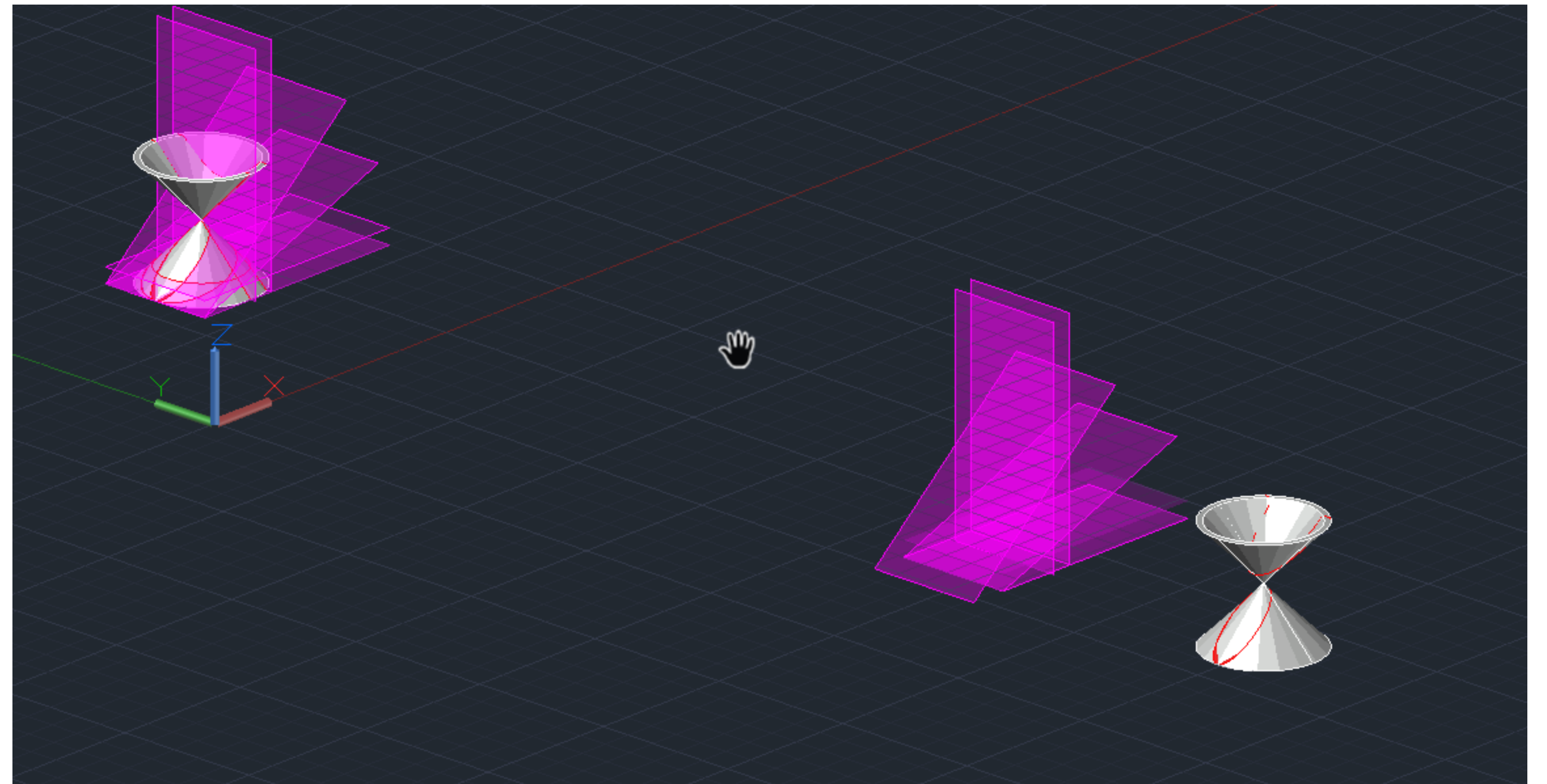
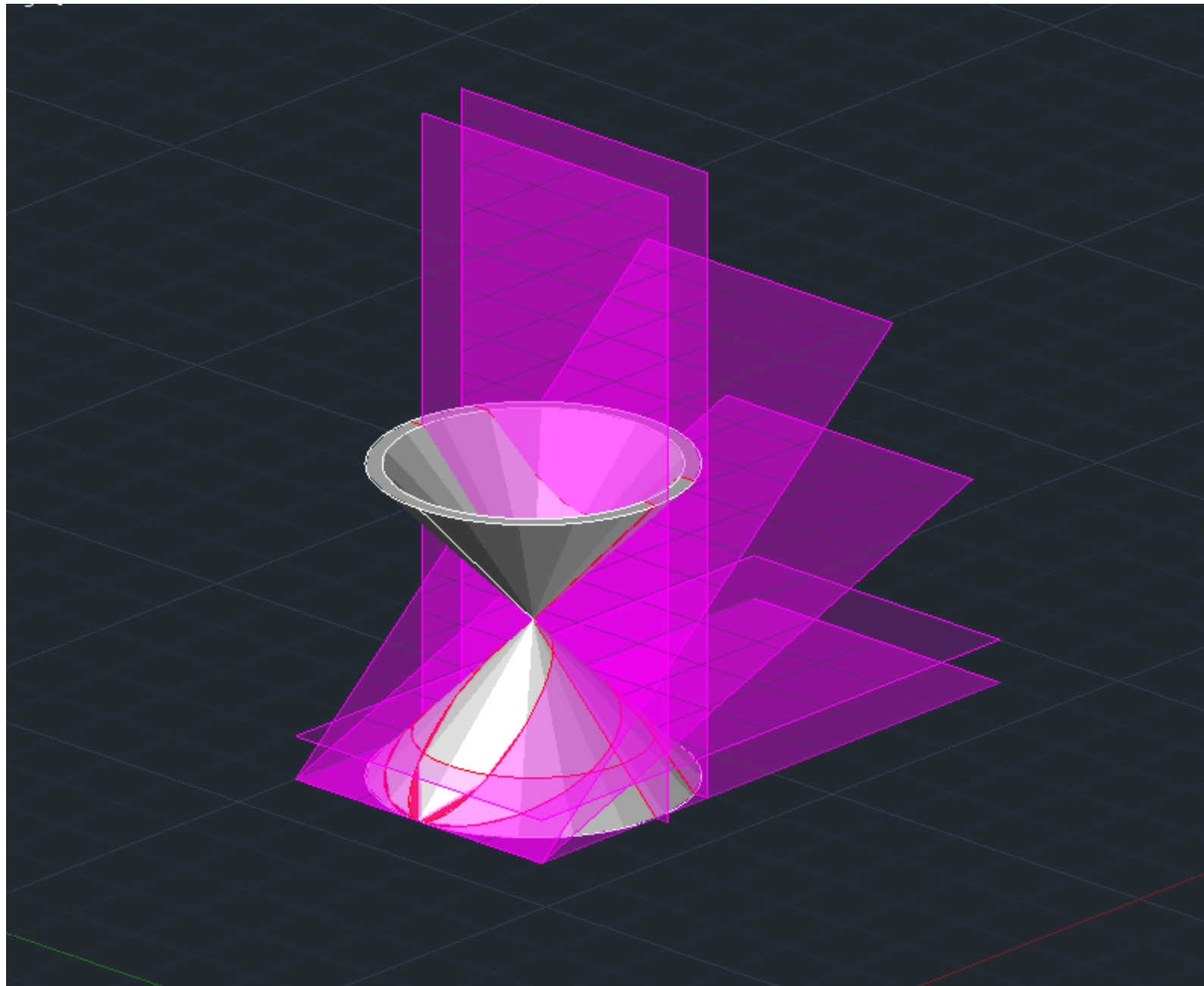

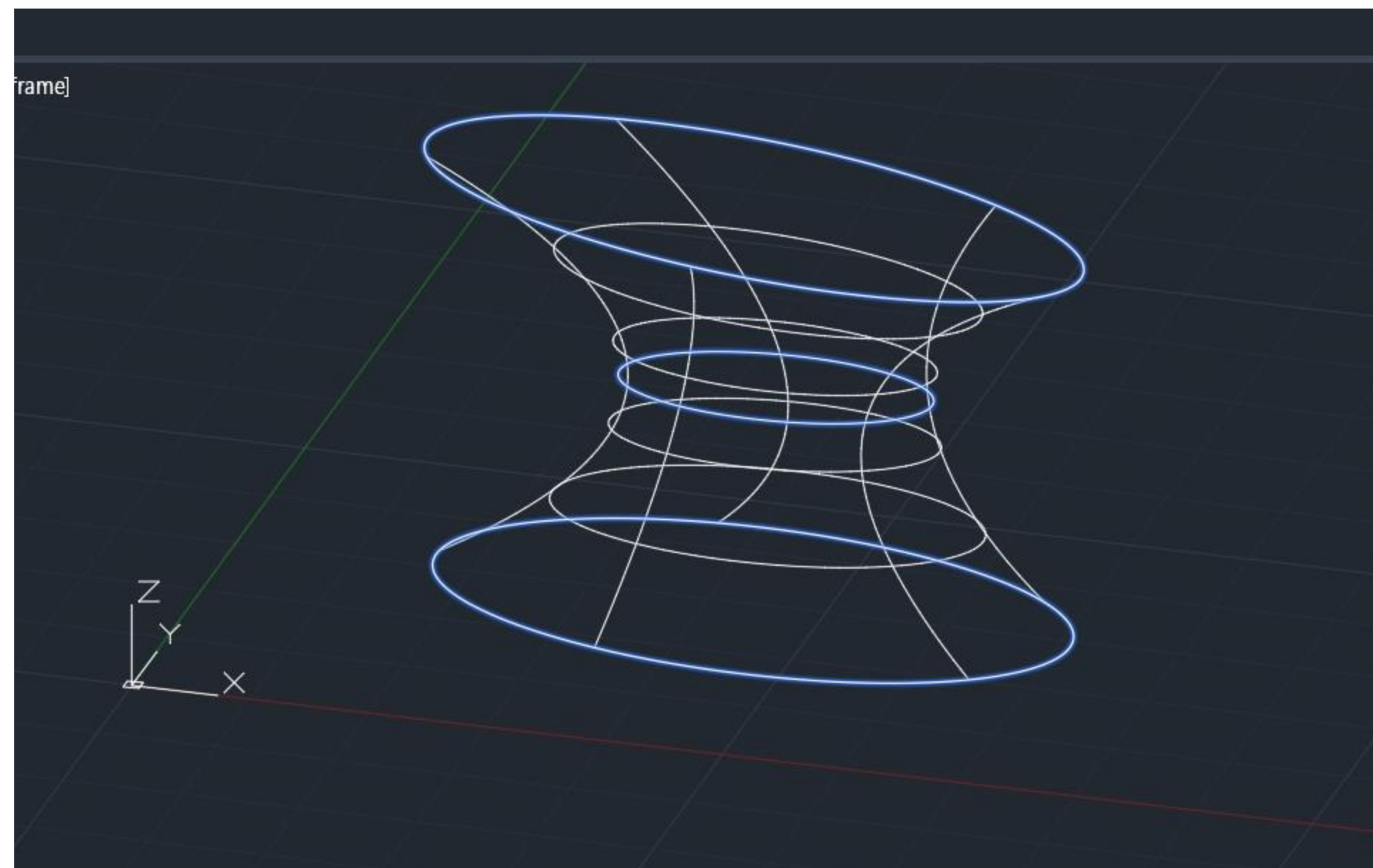
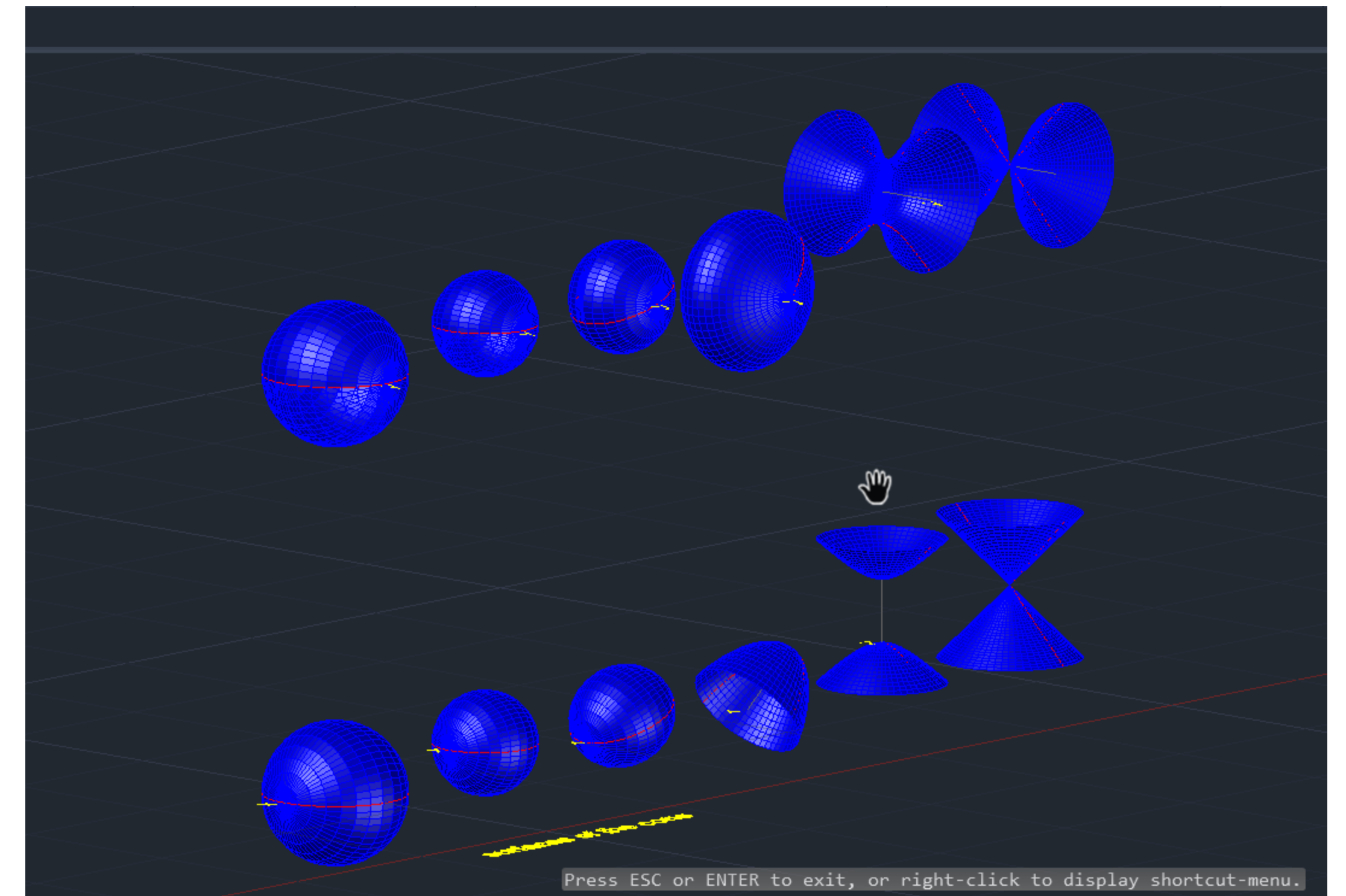
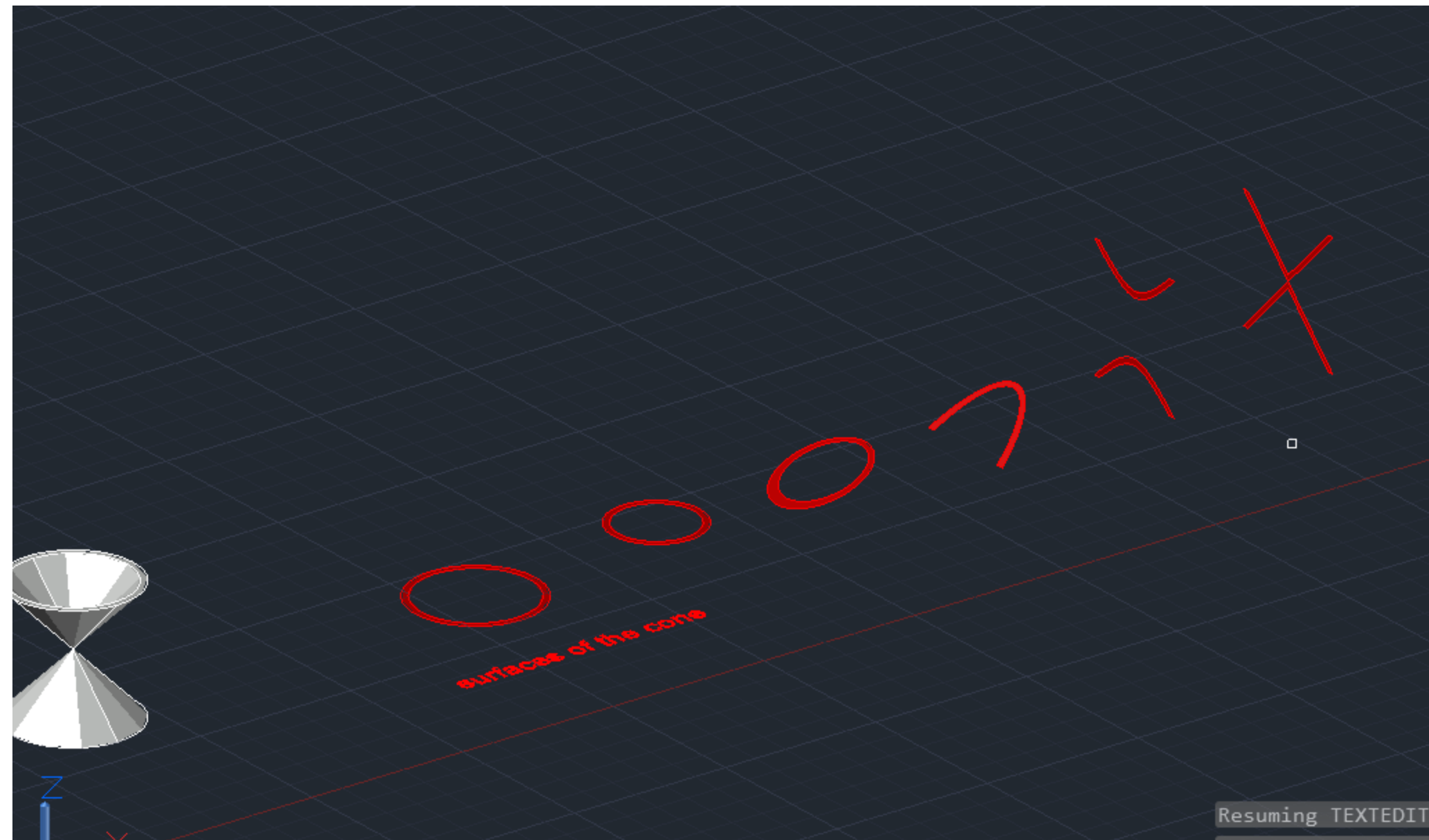

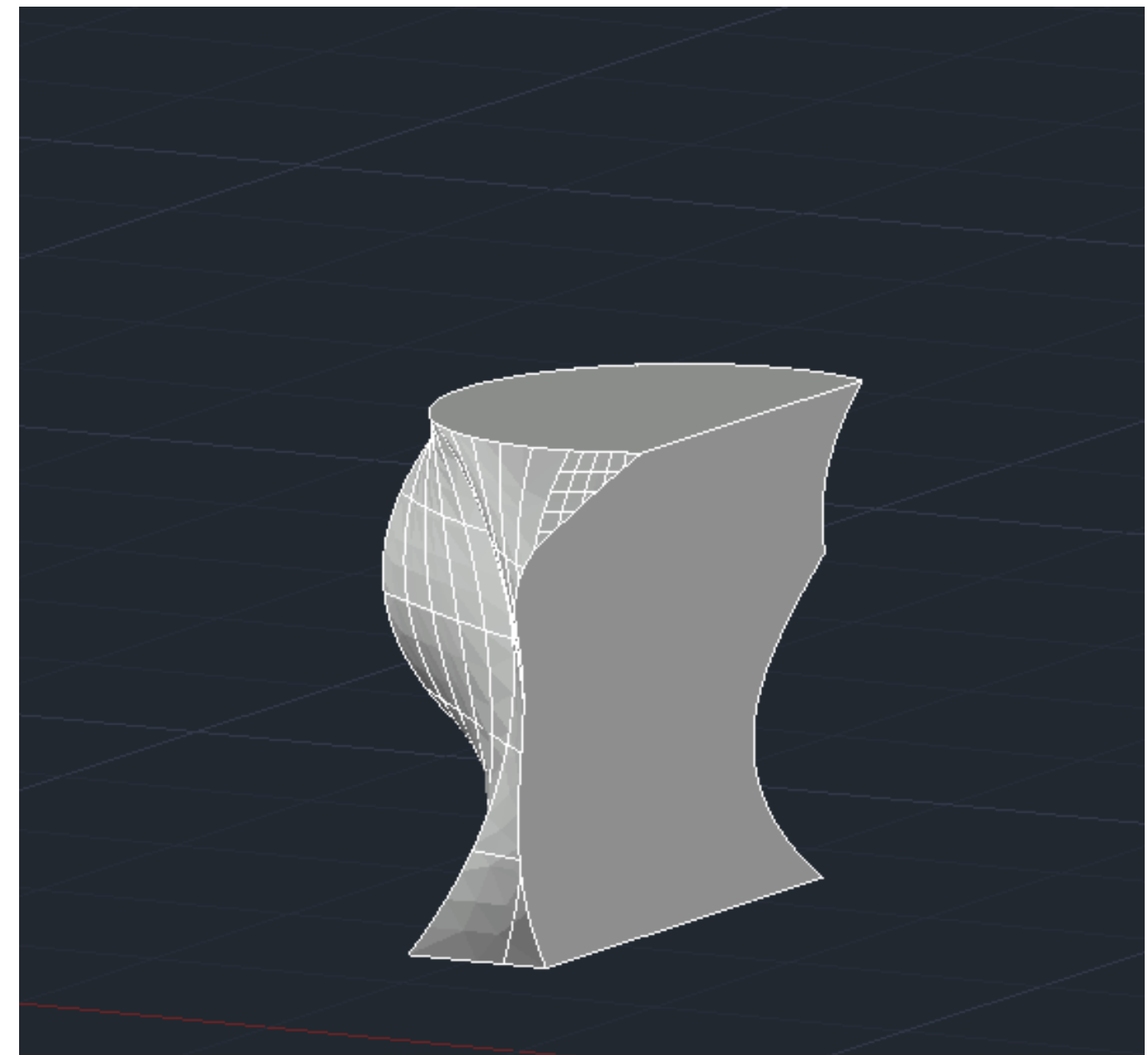
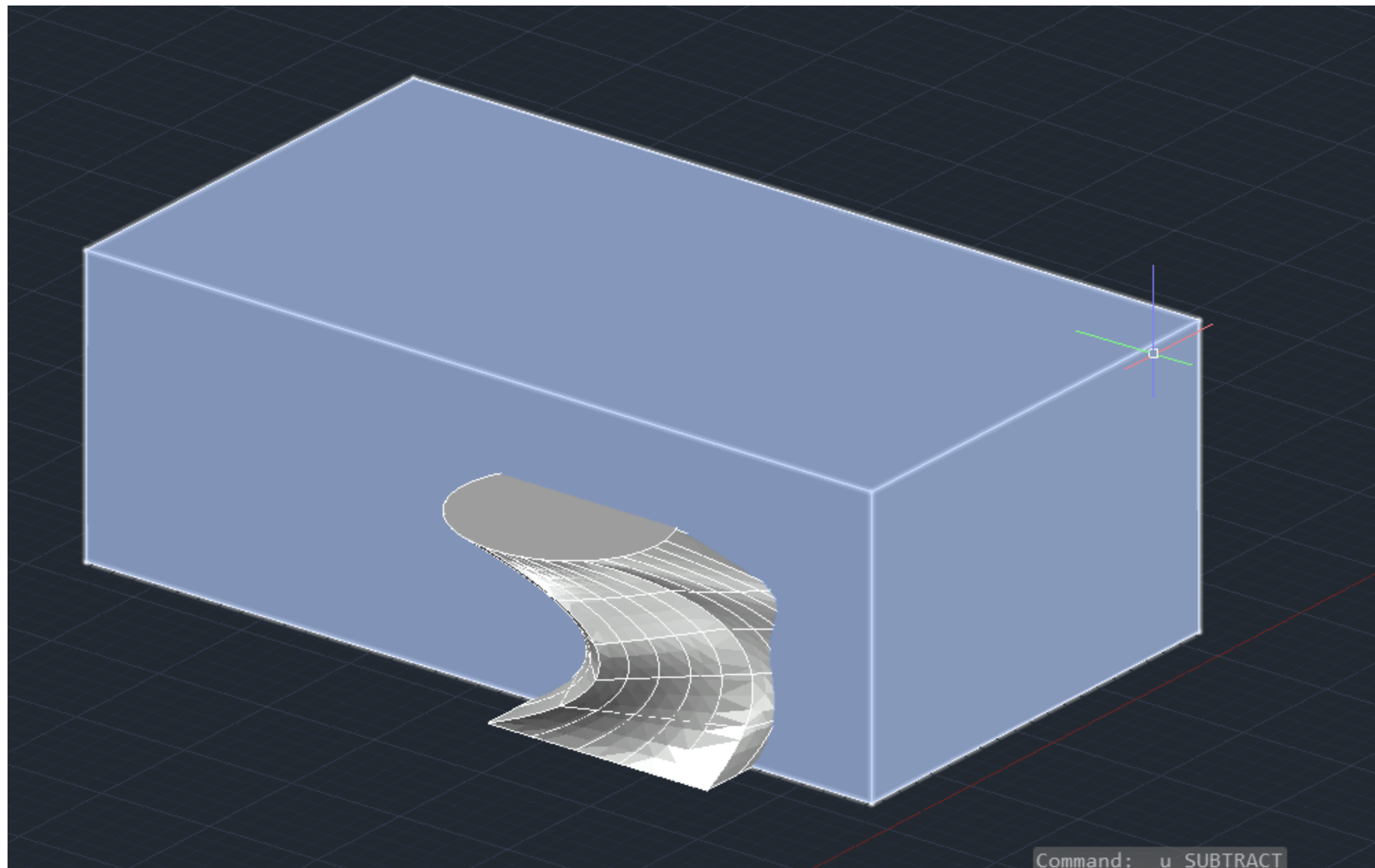
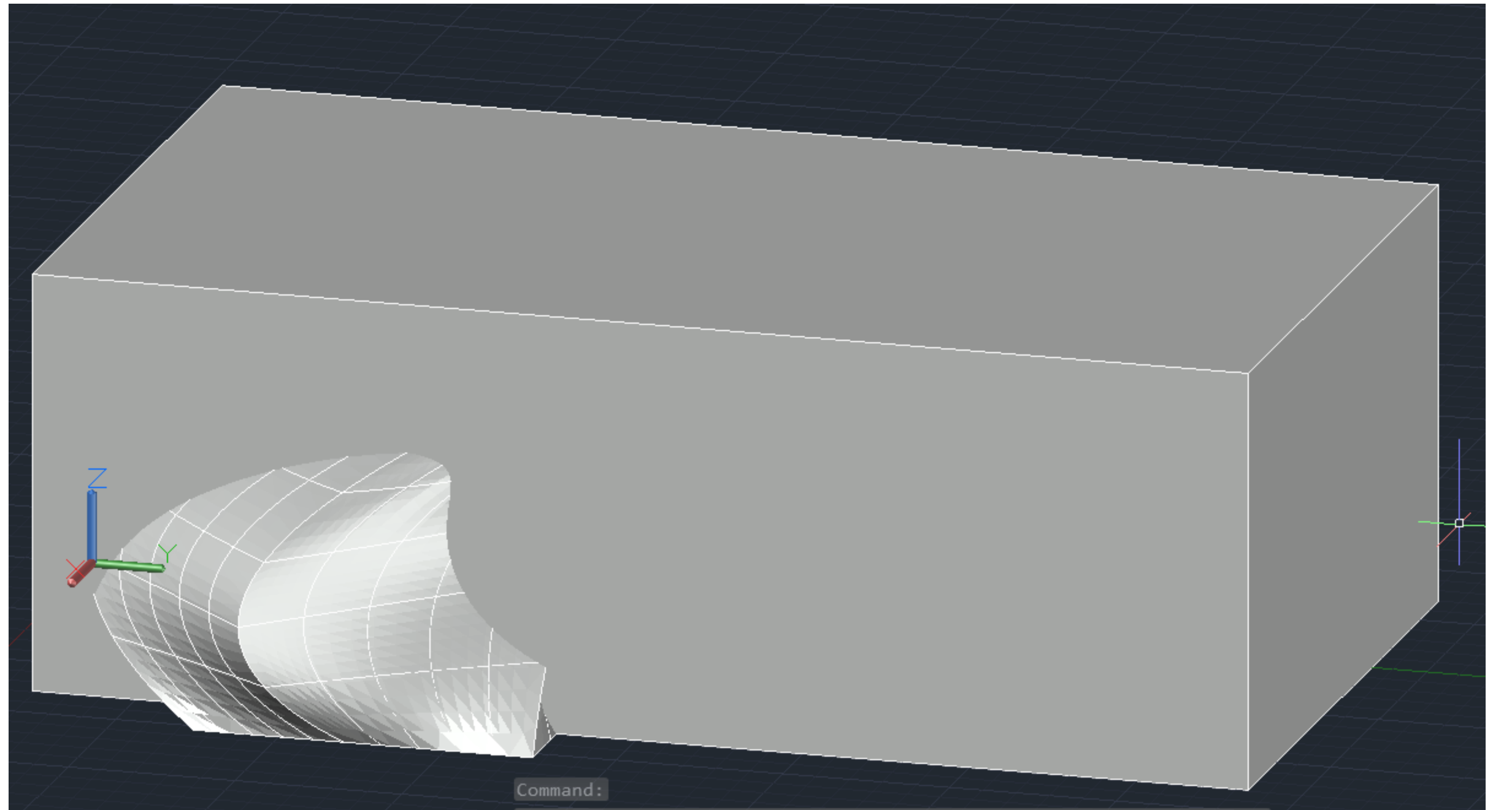
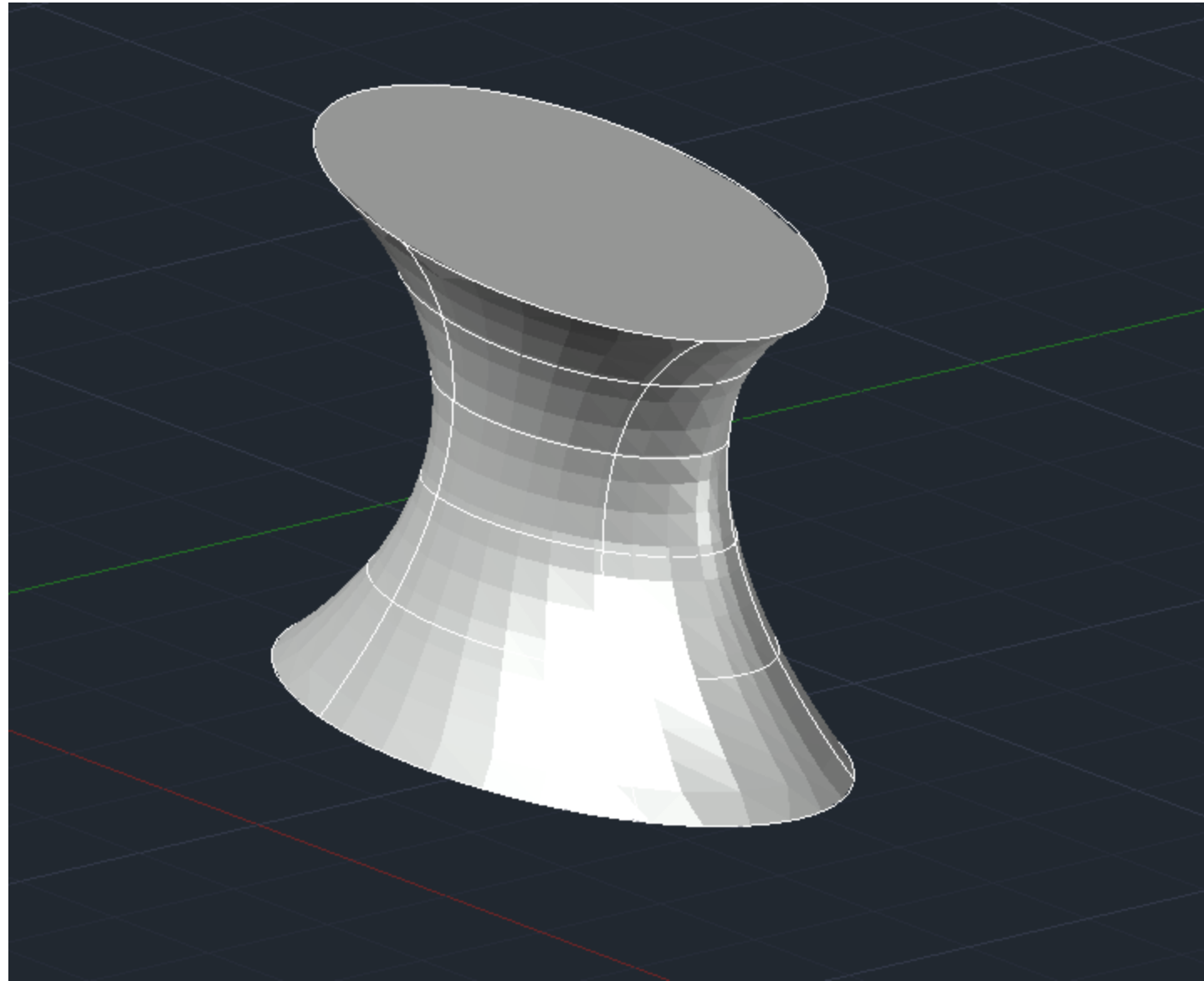

Aula 20 - 30 de Novembro

- Introdução ao uso do 3DStudioMax

