

# Modelação e Visualização Tridimensional em Arquitectura

**U** LISBOA

UNIVERSIDADE  
DE LISBOA

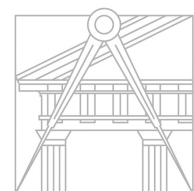

FACULDADE DE ARQUITETURA  
UNIVERSIDADE DE LISBOA

Mestrado Integrado em Arquitectura  
Ano Lectivo 2022-2023 2º Semestre  
Docente - Nuno Alão 3º Ano



Cosmina Pop 20201200 Margarida Almas 20201320 Mariana Monteiro 20201476 Mariana Reis 20201326 Marta Capinha 20181490

# Guggenheim

## TRABALHO DE GRUPO

## ÍNDICE

- Fontes de Trabalho \_\_\_\_\_ Pág. 4-5
- Pisos do Edifício \_\_\_\_\_ Pág. 6-13
- Modelo 3D \_\_\_\_\_ Pág. 14-15

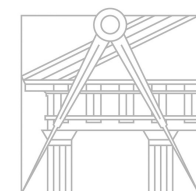

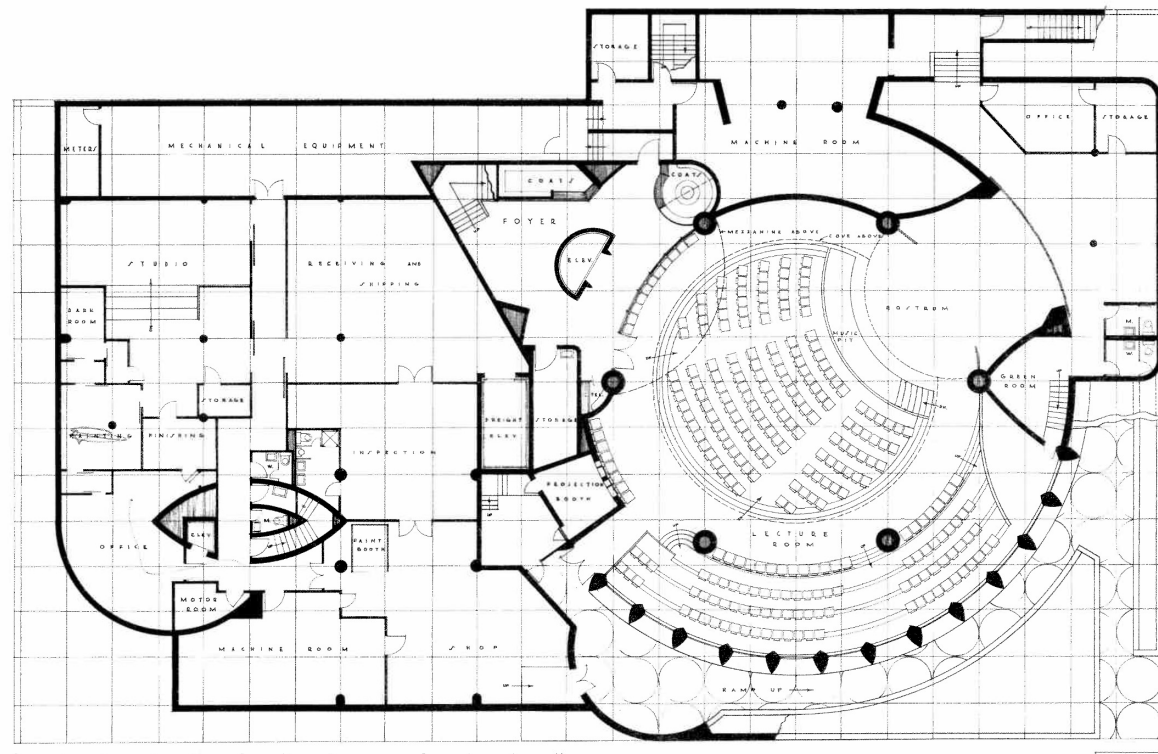

BASEMENT PLAN  
THE SOLOMON R. GUGGENHEIM MUSEUM  
FRANK LLOYD WRIGHT ARCHITECT

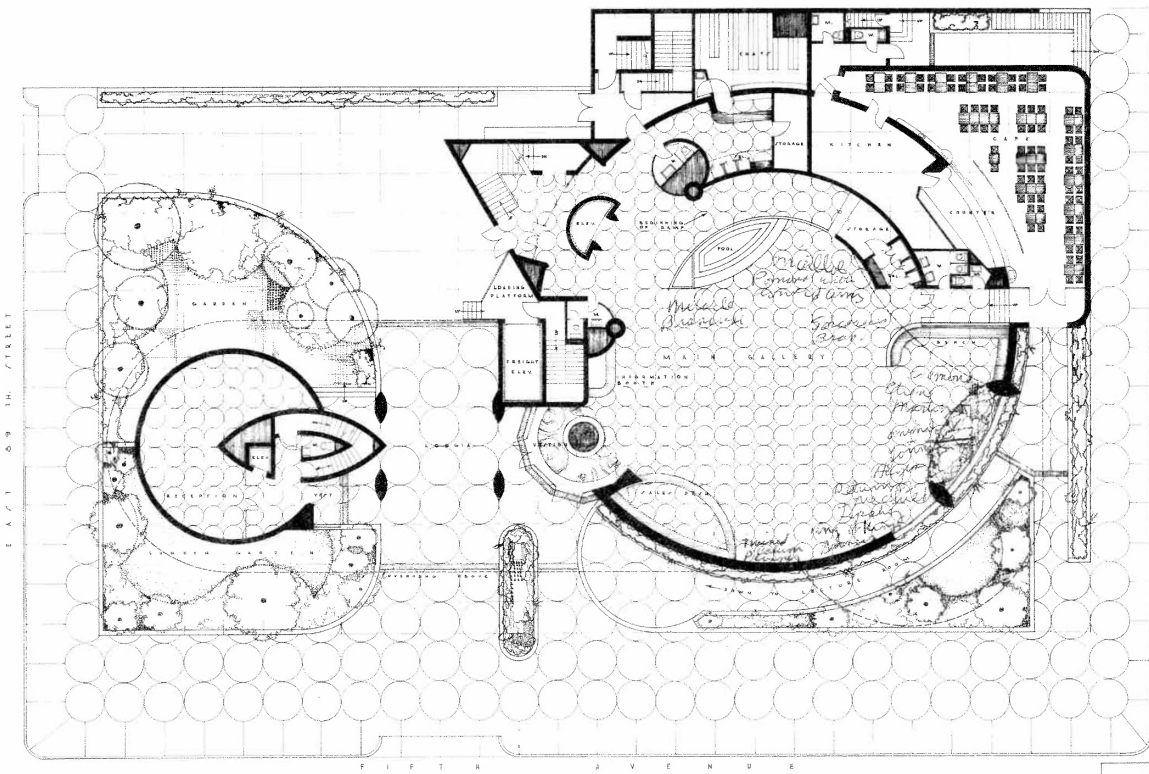

GROUND LEVEL  
THE SOLOMON R. GUGGENHEIM MUSEUM  
FRANK LLOYD WRIGHT ARCHITECT

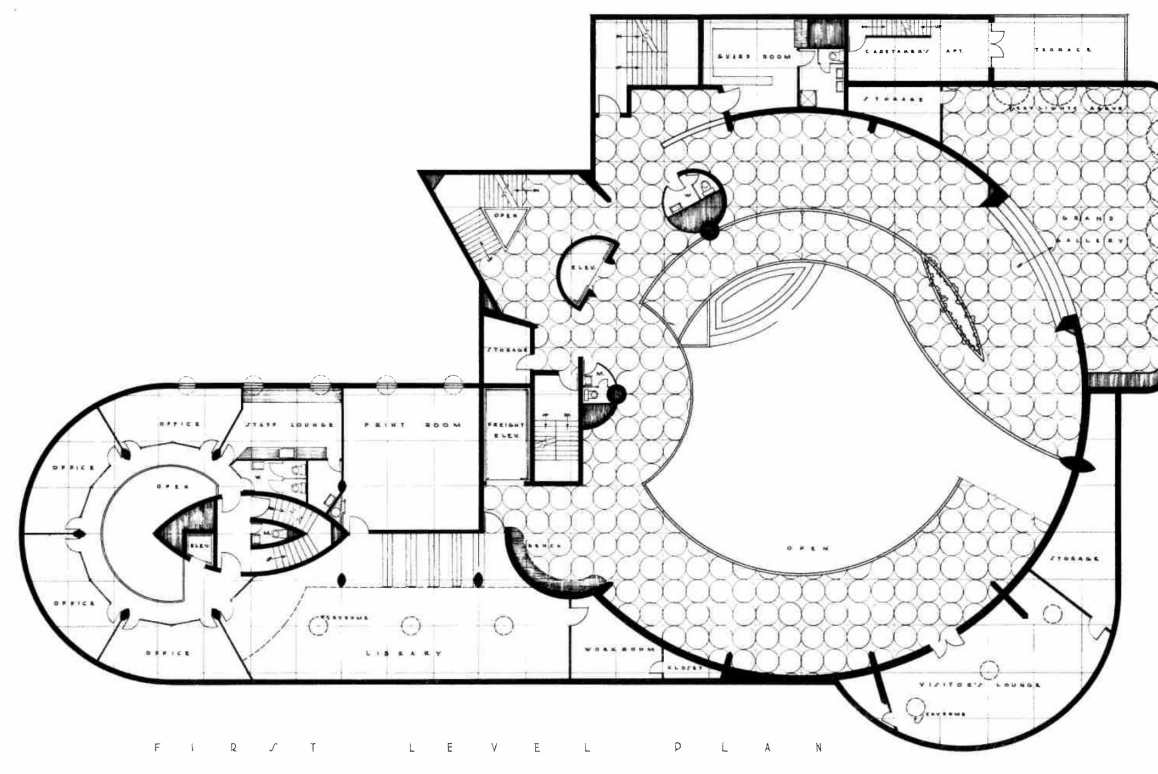

FIRST LEVEL PLAN  
THE SOLOMON R. GUGGENHEIM MUSEUM  
FRANK LLOYD WRIGHT ARCHITECT

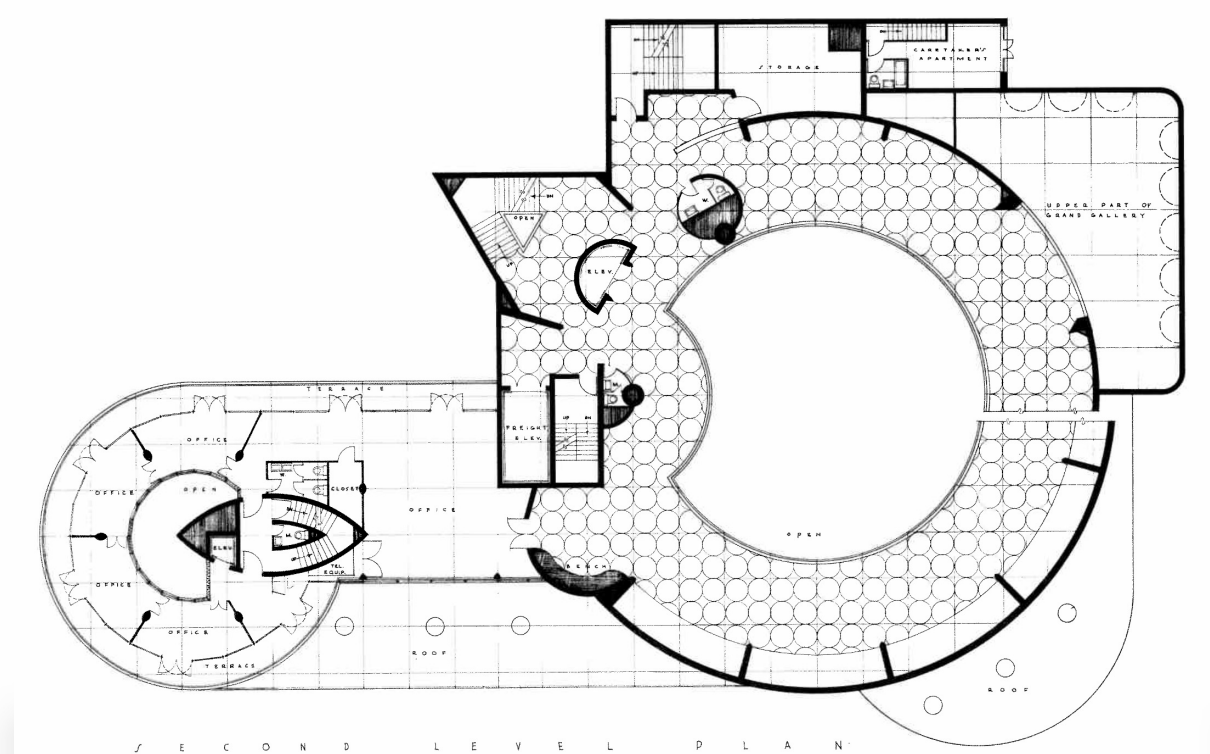

SECOND LEVEL PLAN  
THE SOLOMON R. GUGGENHEIM MUSEUM  
FRANK LLOYD WRIGHT ARCHITECT

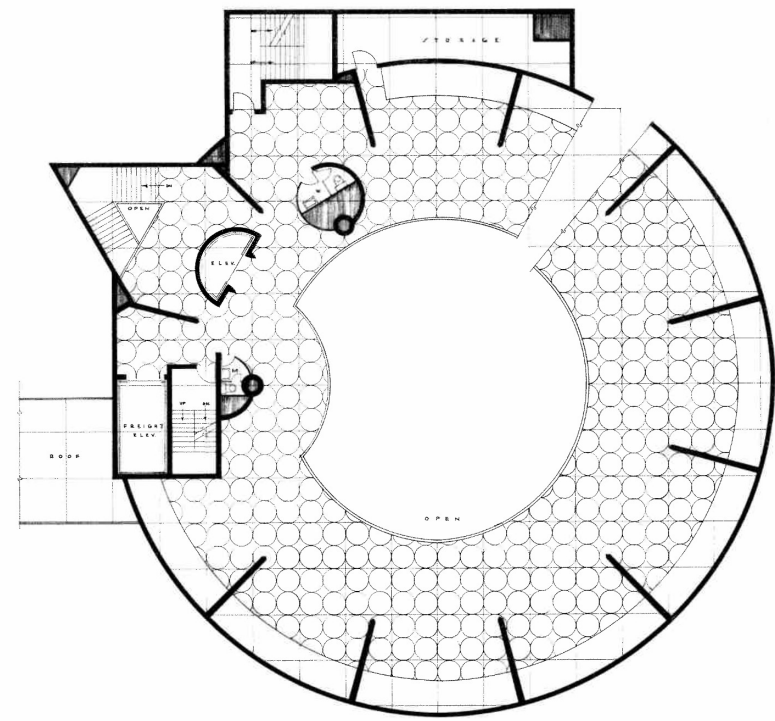

FOURTH LEVEL PLAN  
THE SOLOMON R. GUGGENHEIM MUSEUM  
FRANK LLOYD WRIGHT ARCHITECT

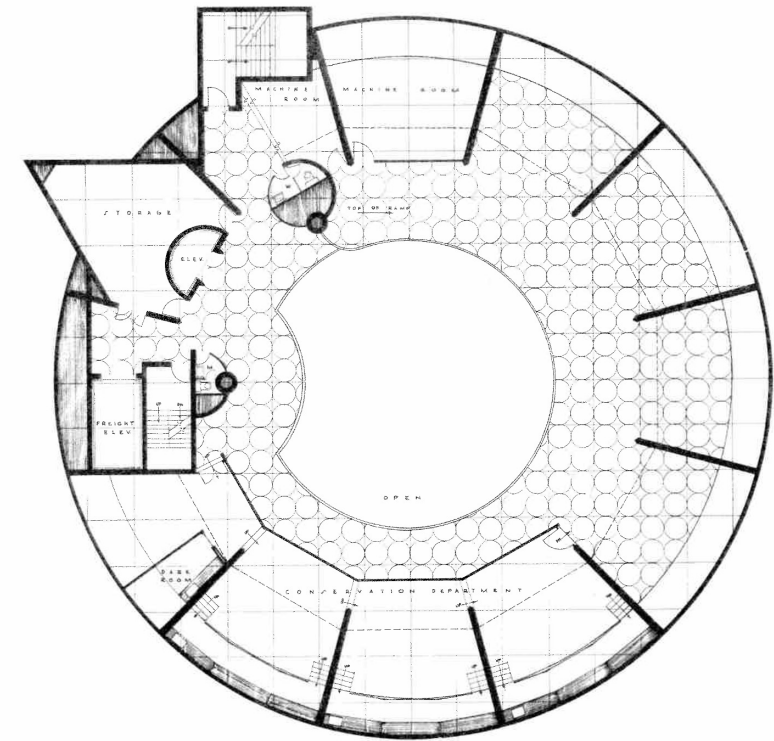

FIFTH LEVEL PLAN  
THE SOLOMON R. GUGGENHEIM MUSEUM  
FRANK LLOYD WRIGHT ARCHITECT

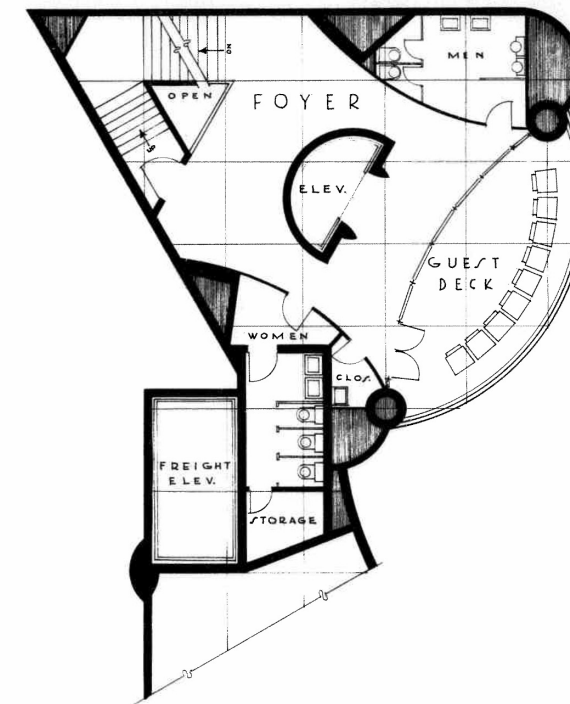

PLAN OF MEZZANINE  
THE SOLOMON R. GUGGENHEIM  
FOUND MUSEUM  
FRANK LLOYD WRIGHT ARCHITECT

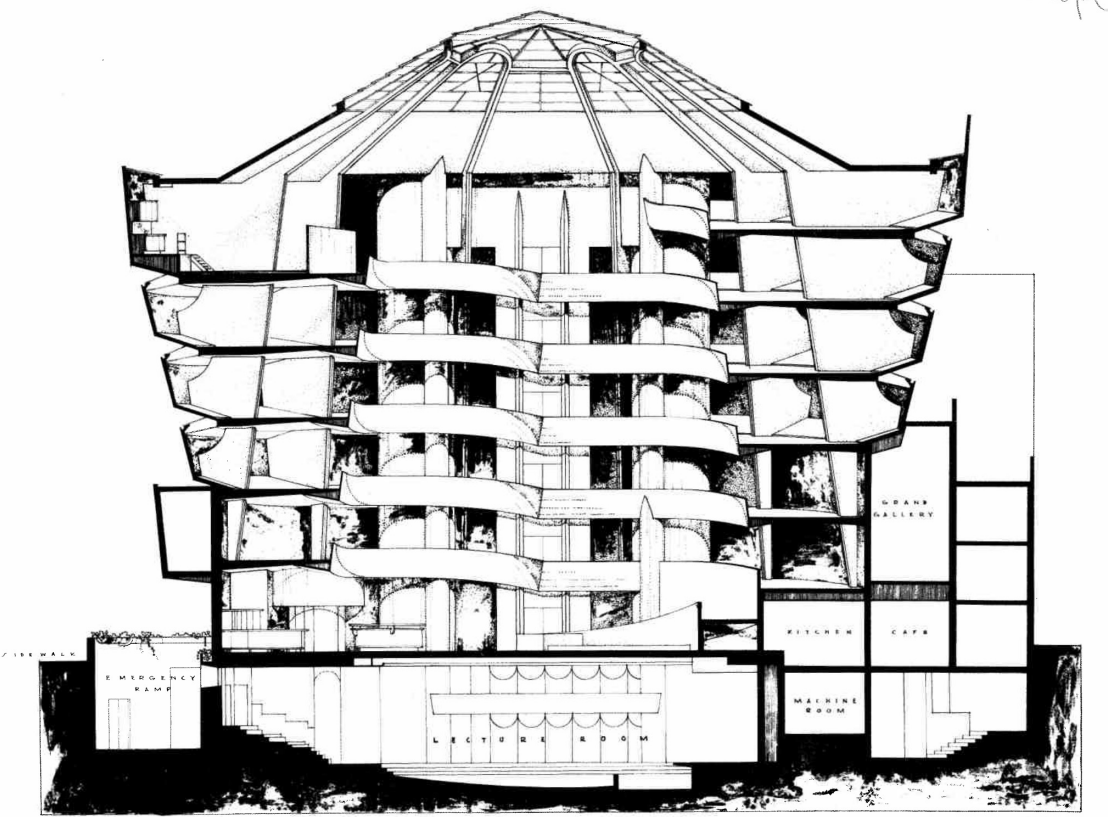

SECTION THROUGH MAIN GALLERY  
THE SOLOMON R. GUGGENHEIM MUSEUM  
FRANK LLOYD WRIGHT ARCHITECT

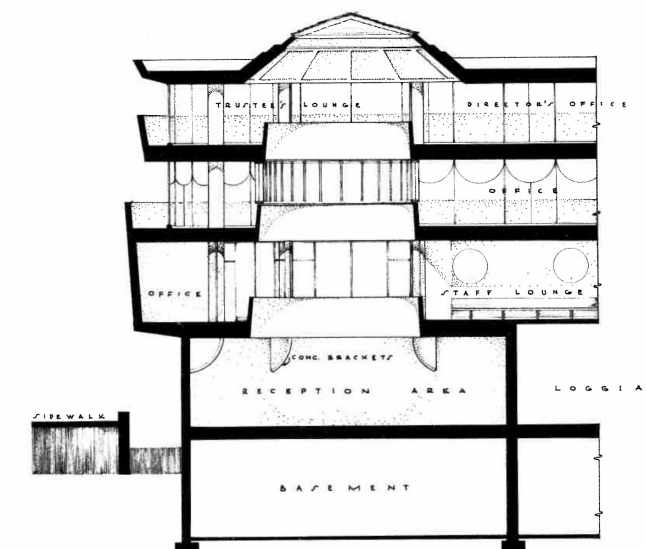

SECTION THROUGH ADMINISTRATION  
BUILDING  
THE SOLOMON R. GUGGENHEIM MUSEUM  
FRANK LLOYD WRIGHT ARCHITECT

Fontes de Trabalho

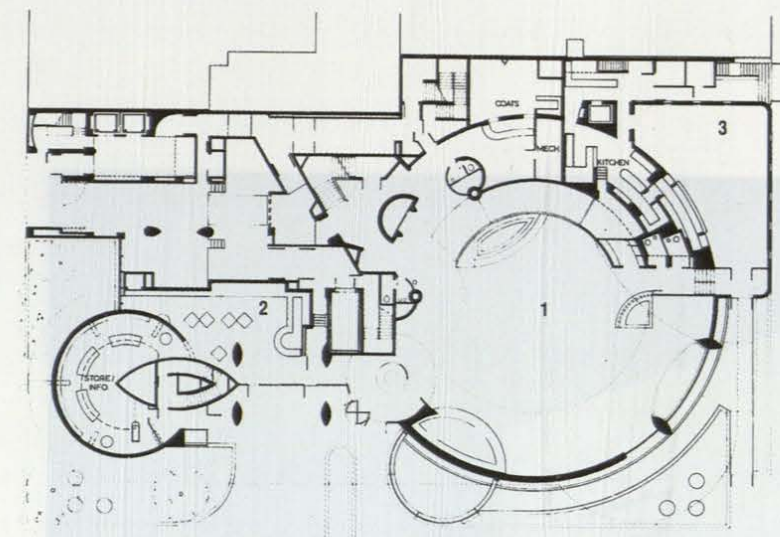

**Planta Baja**  
1 Exposiciones temporales  
2 Librería  
3 Restaurante

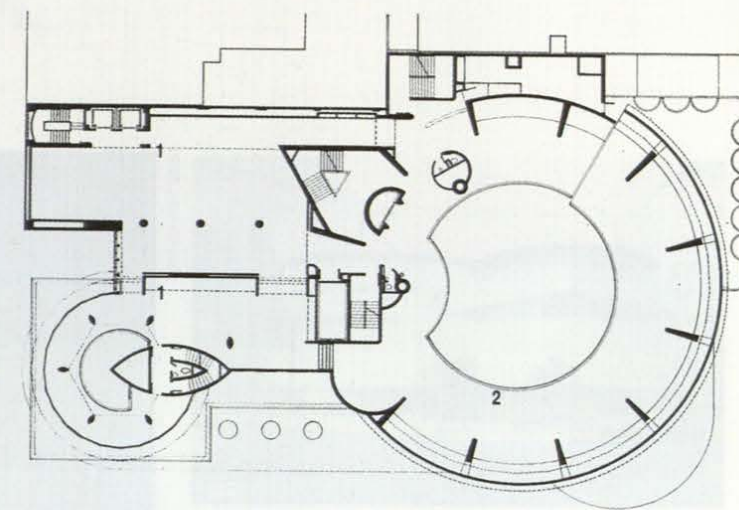

**Planta cuarta**  
1 Colección permanente  
2 Exposiciones temporales

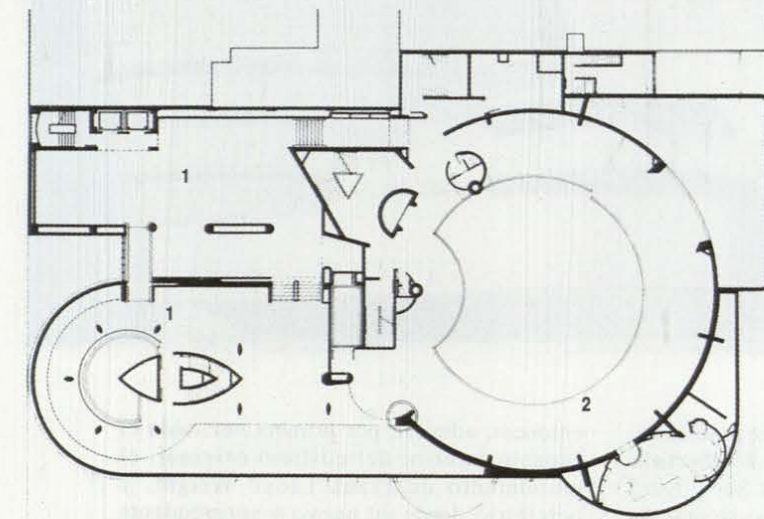

**Planta segunda**  
1 Colección permanente  
2 Exposiciones temporales

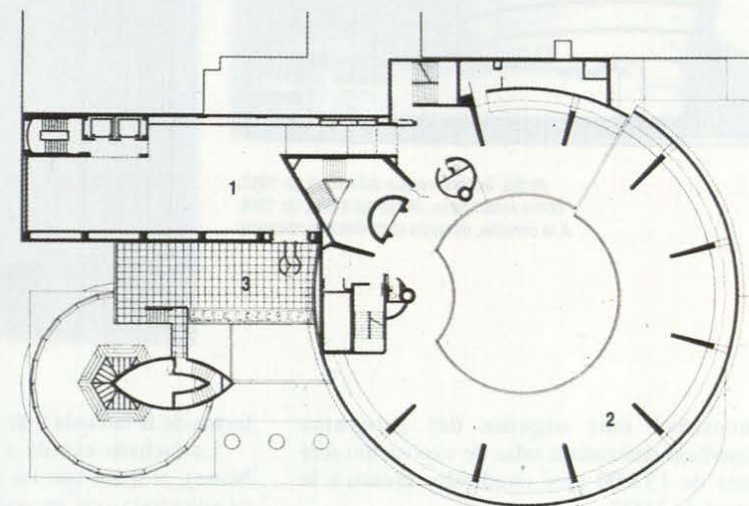

**Planta quinta**  
1 Colección permanente  
2 Exposiciones temporales  
3 Jardín de esculturas

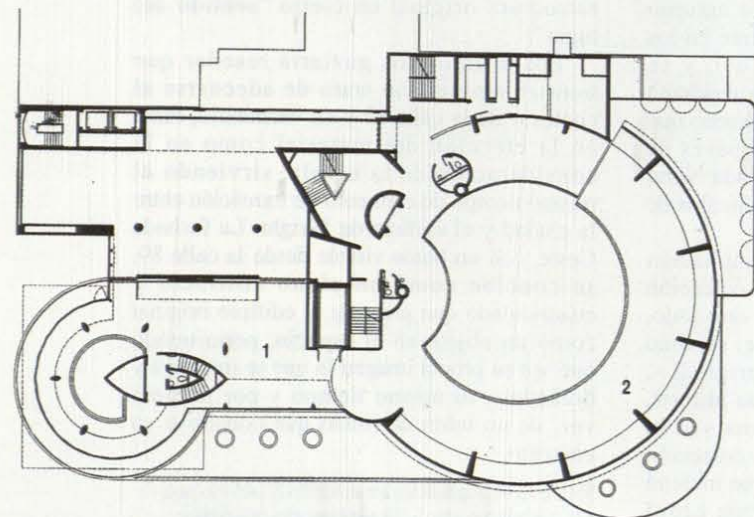

**Planta tercera**  
1 Colección permanente  
2 Exposiciones temporales

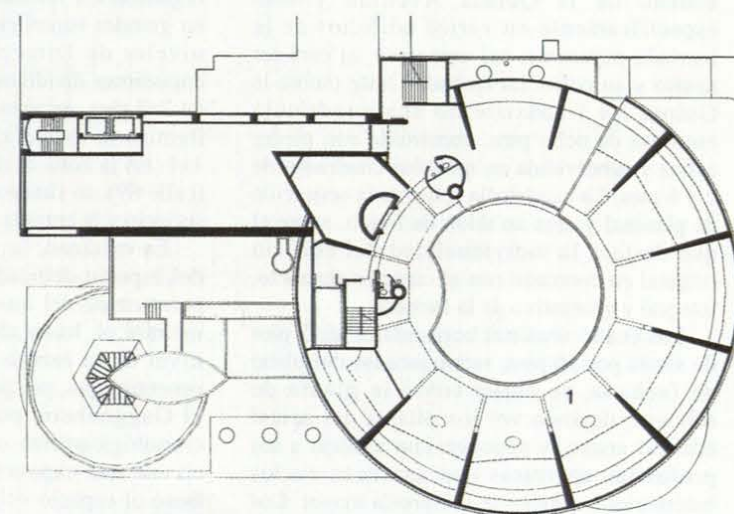

**Planta sexta**  
1 Exposiciones temporales

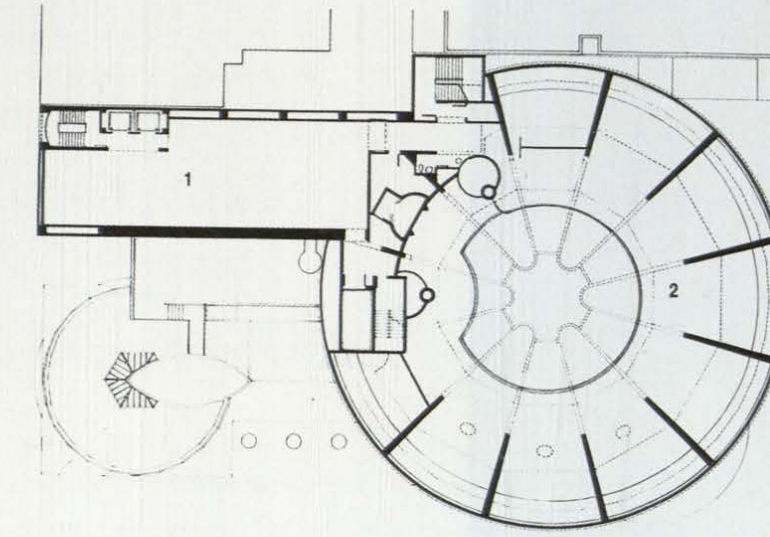

**Planta séptima**  
1 Colección permanente  
2 Exposiciones temporales

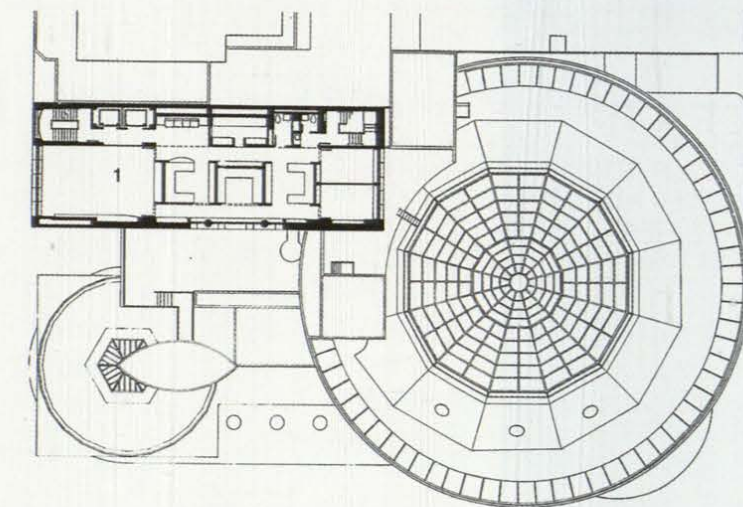

**Planta octava**  
1 Administración

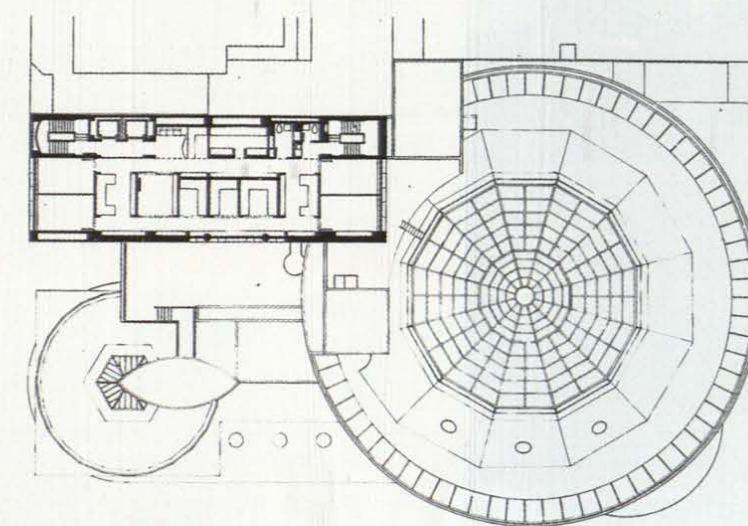

**Planta novena**  
1 Administración

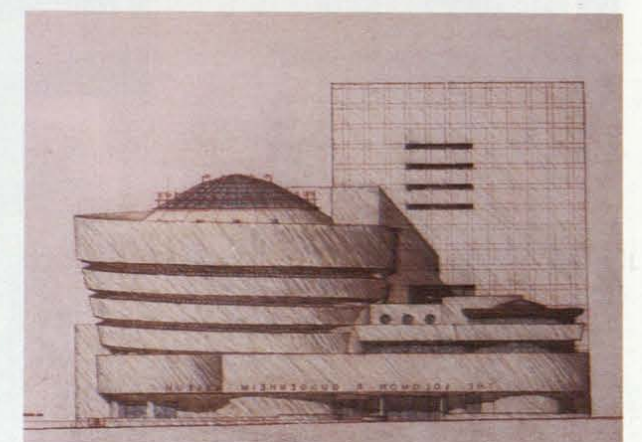
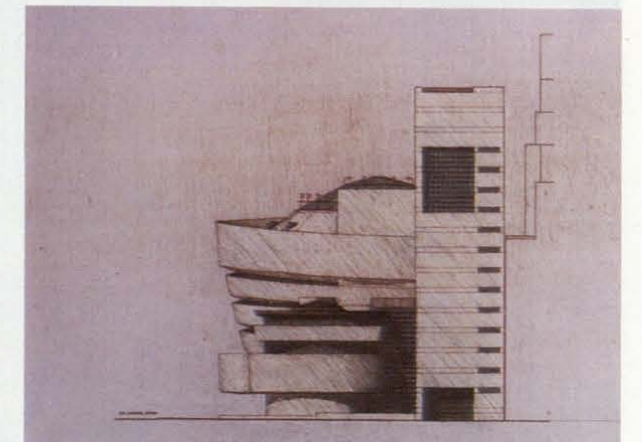
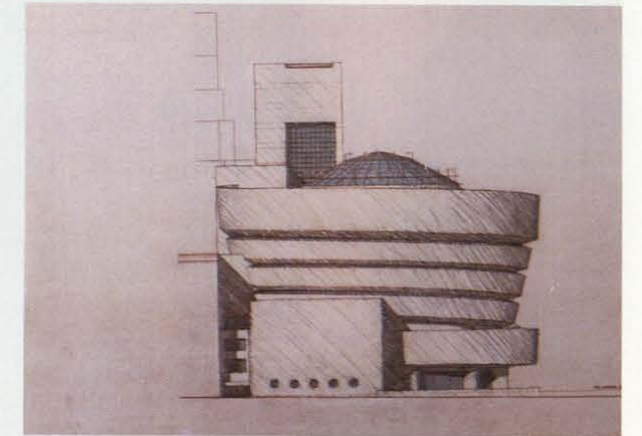
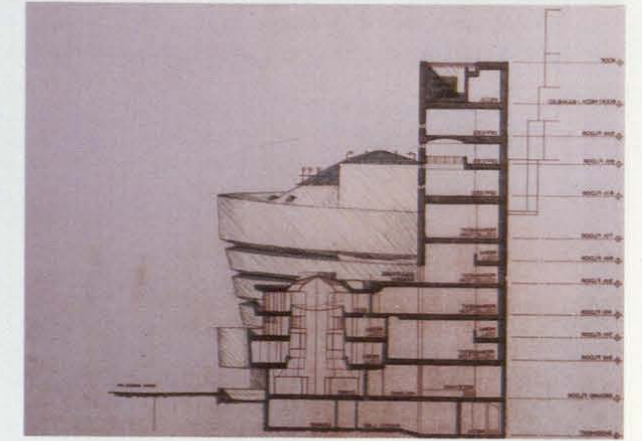

# Fontes de Trabalho

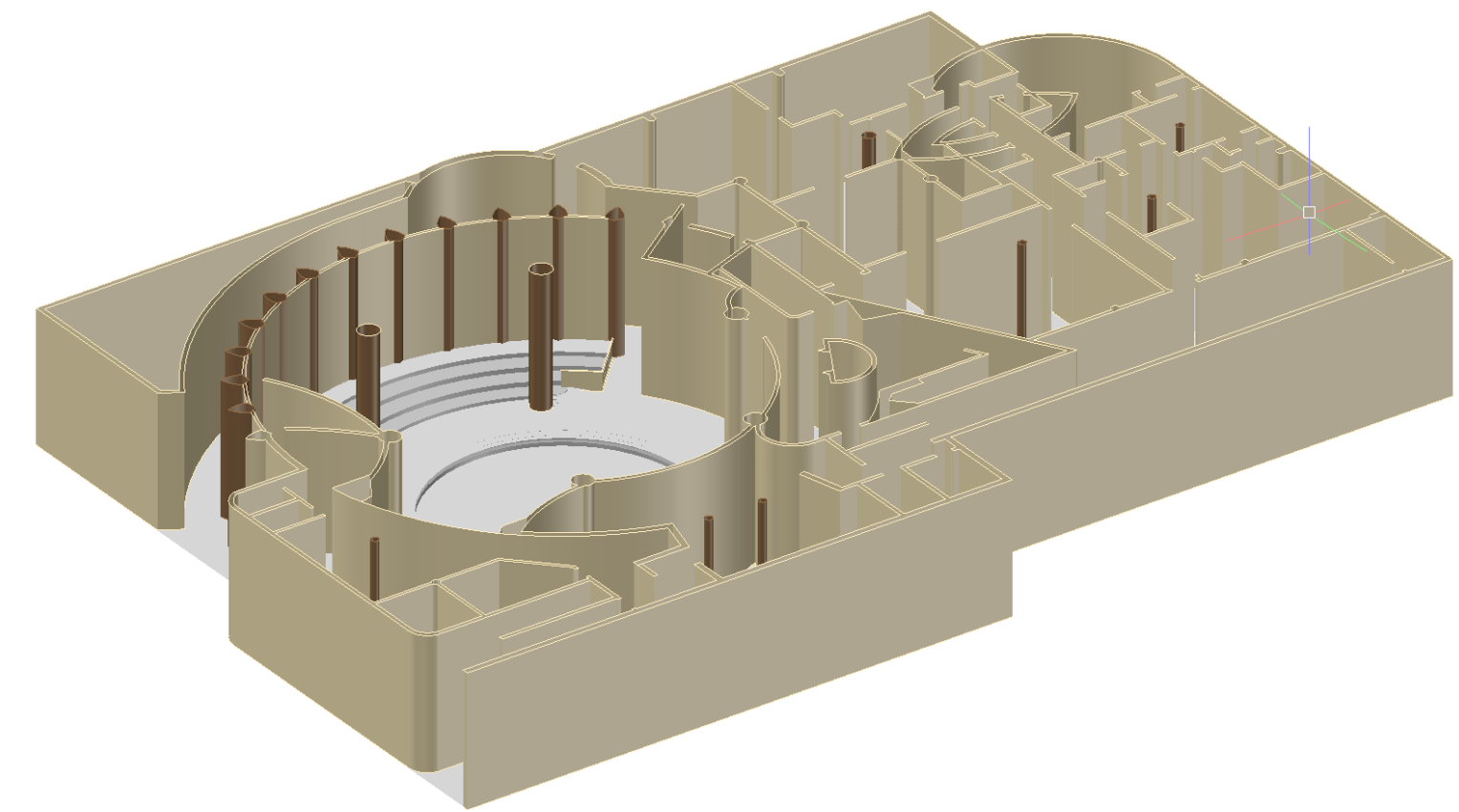
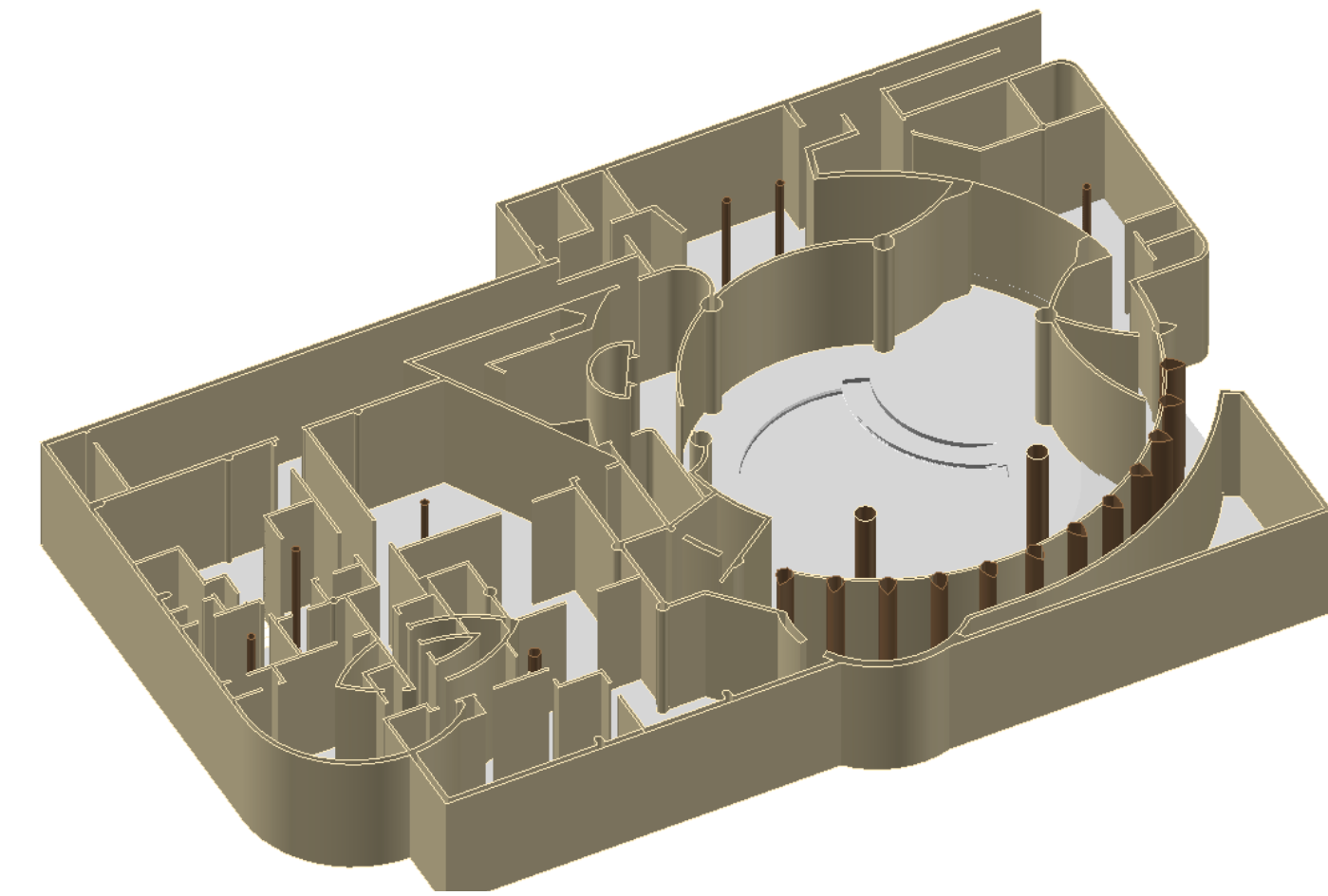
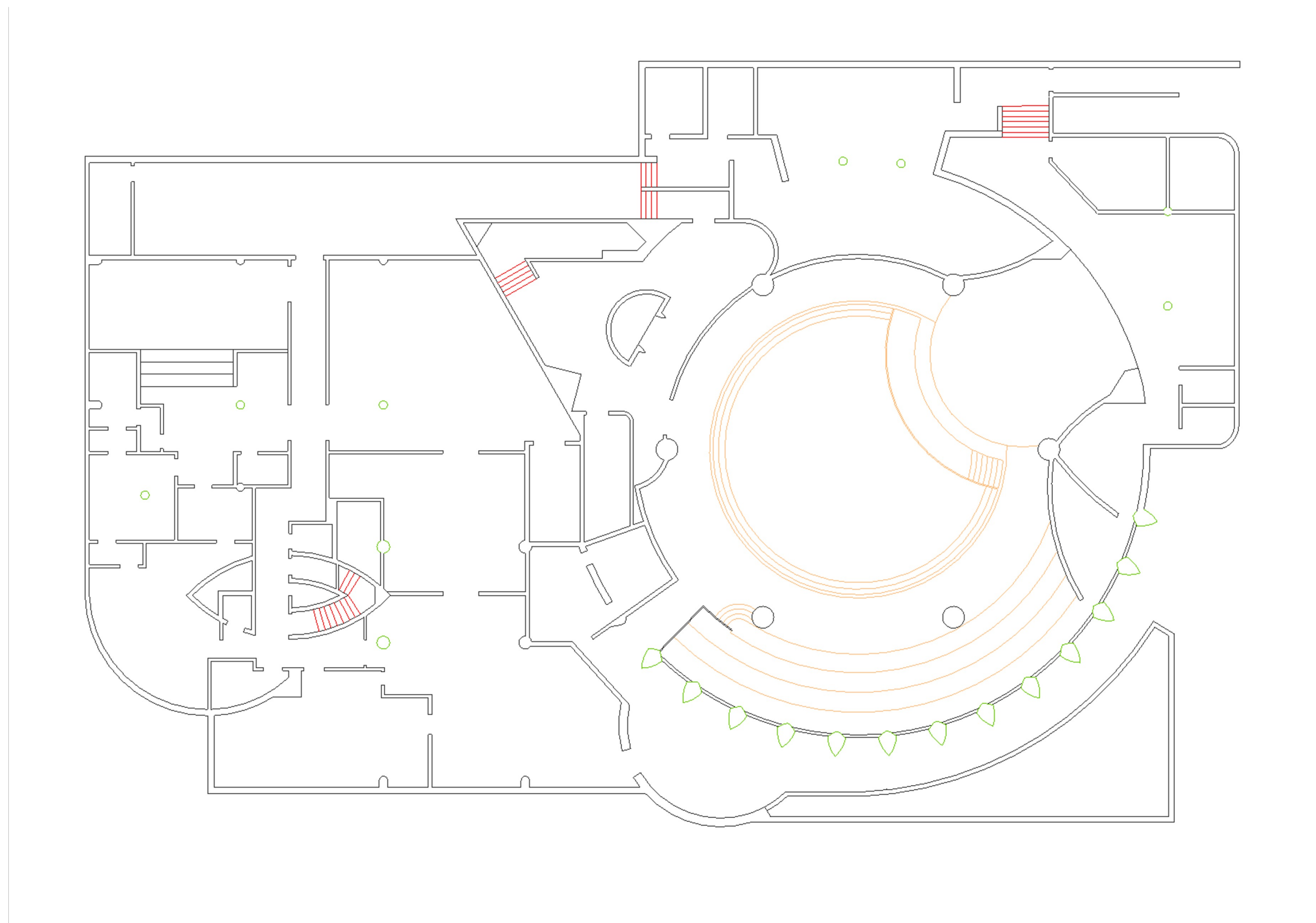

Pisos do Edifício \_ PISO -1

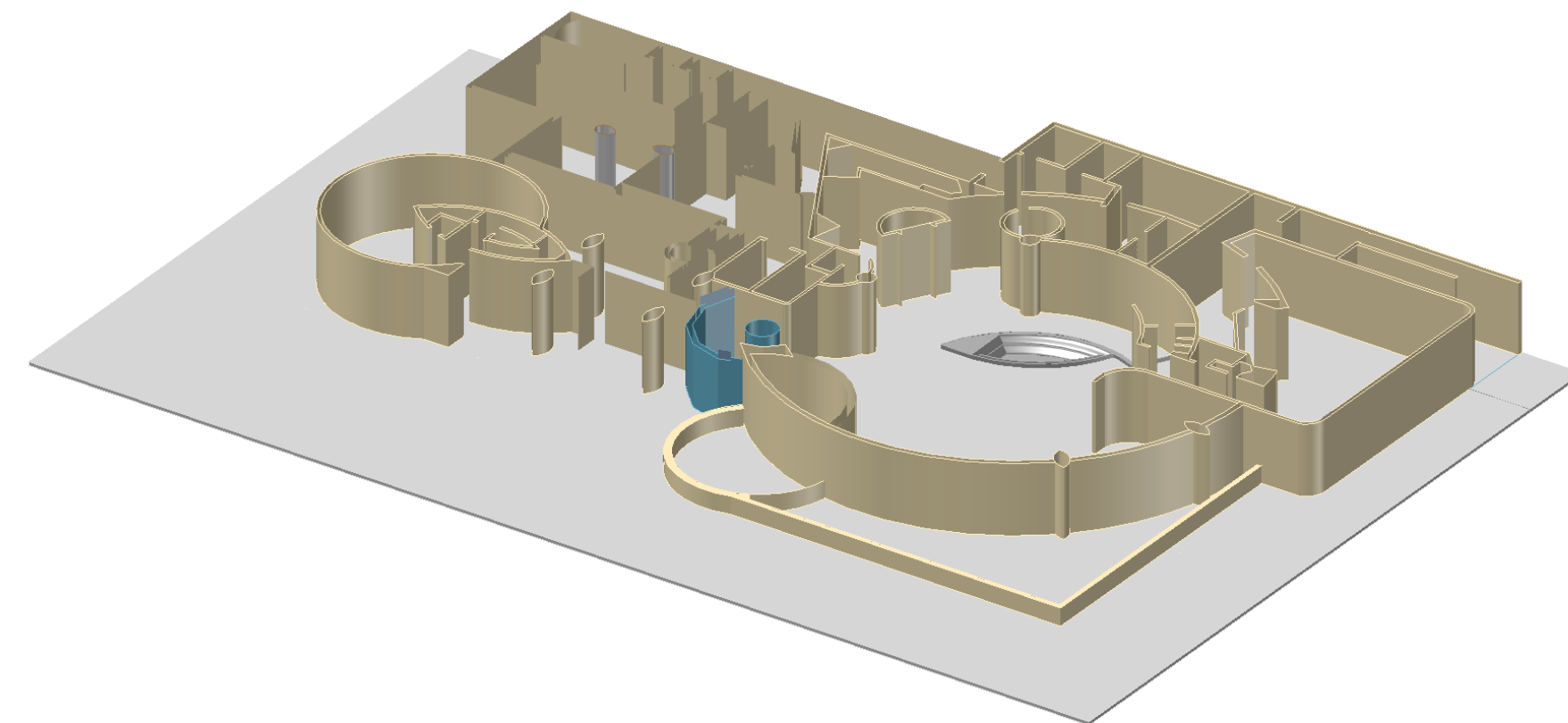
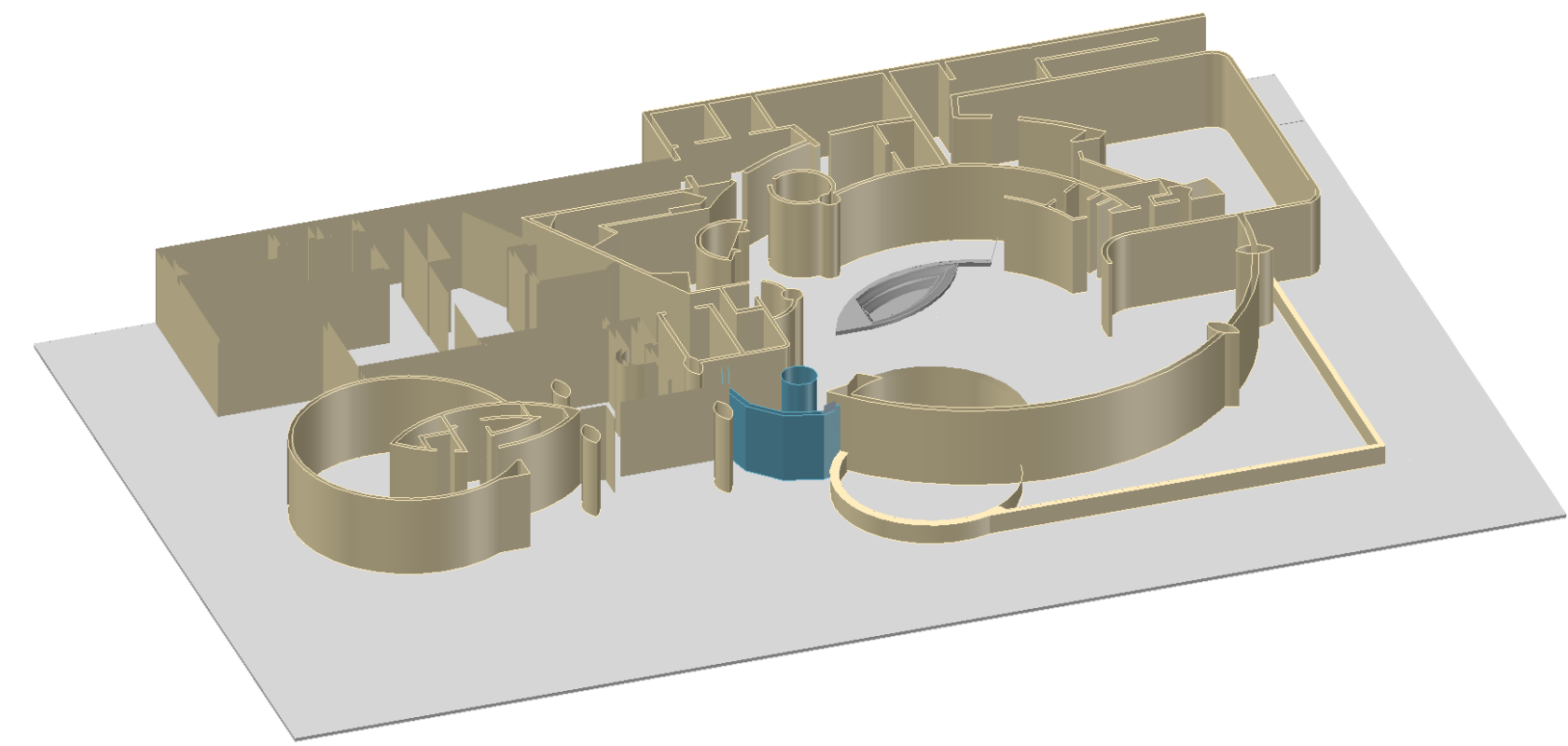
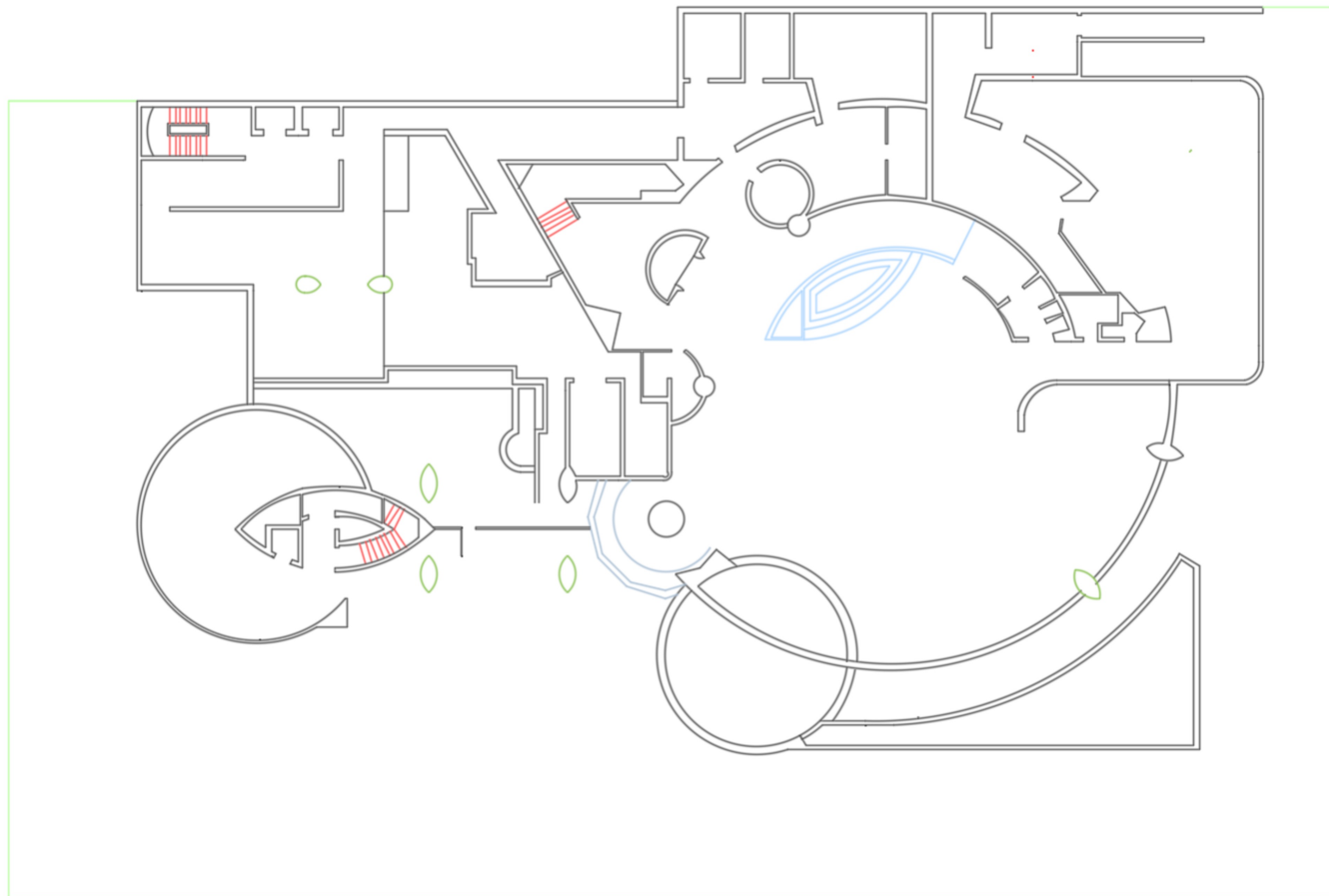

# Pisos do Edifício \_ PISO 0

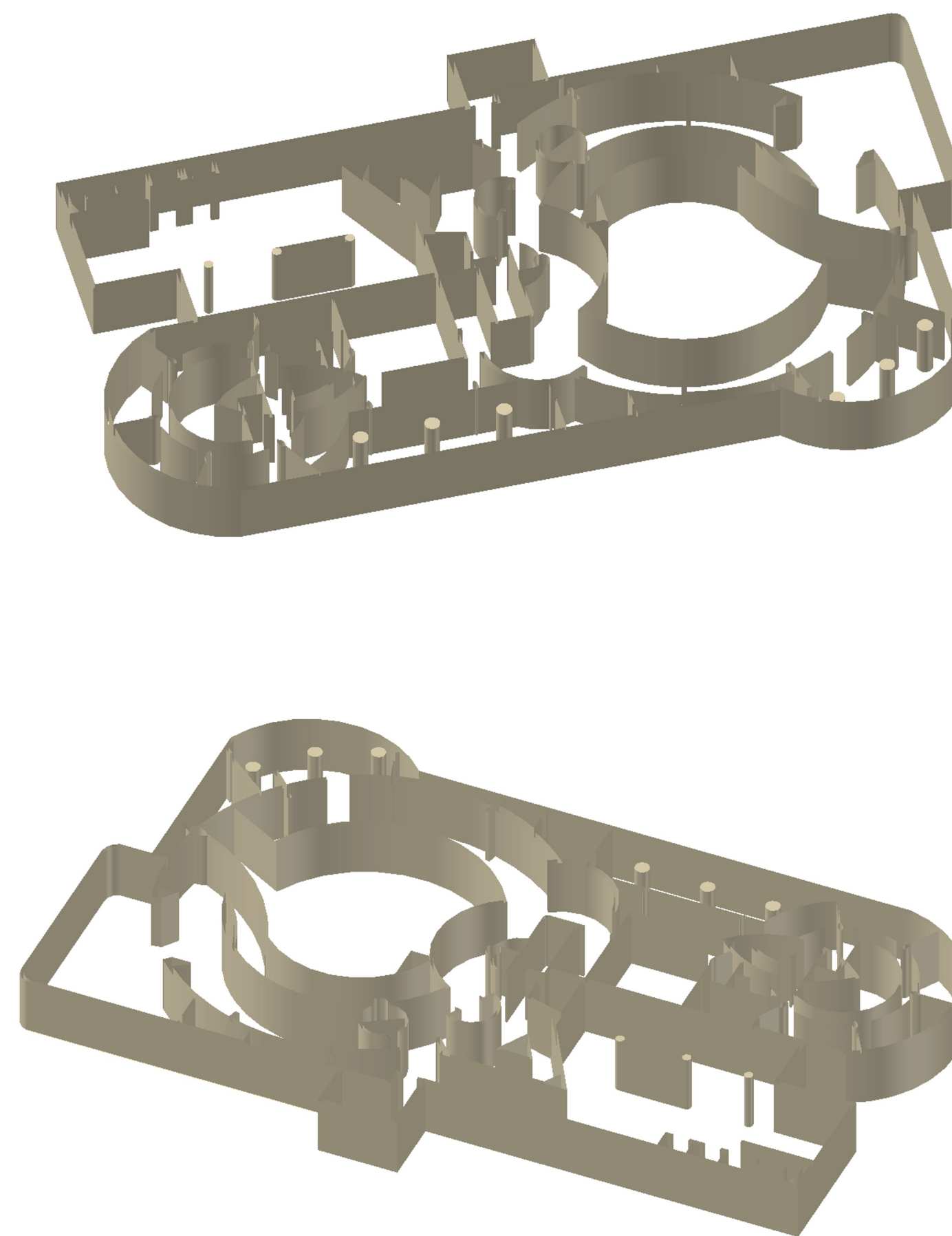
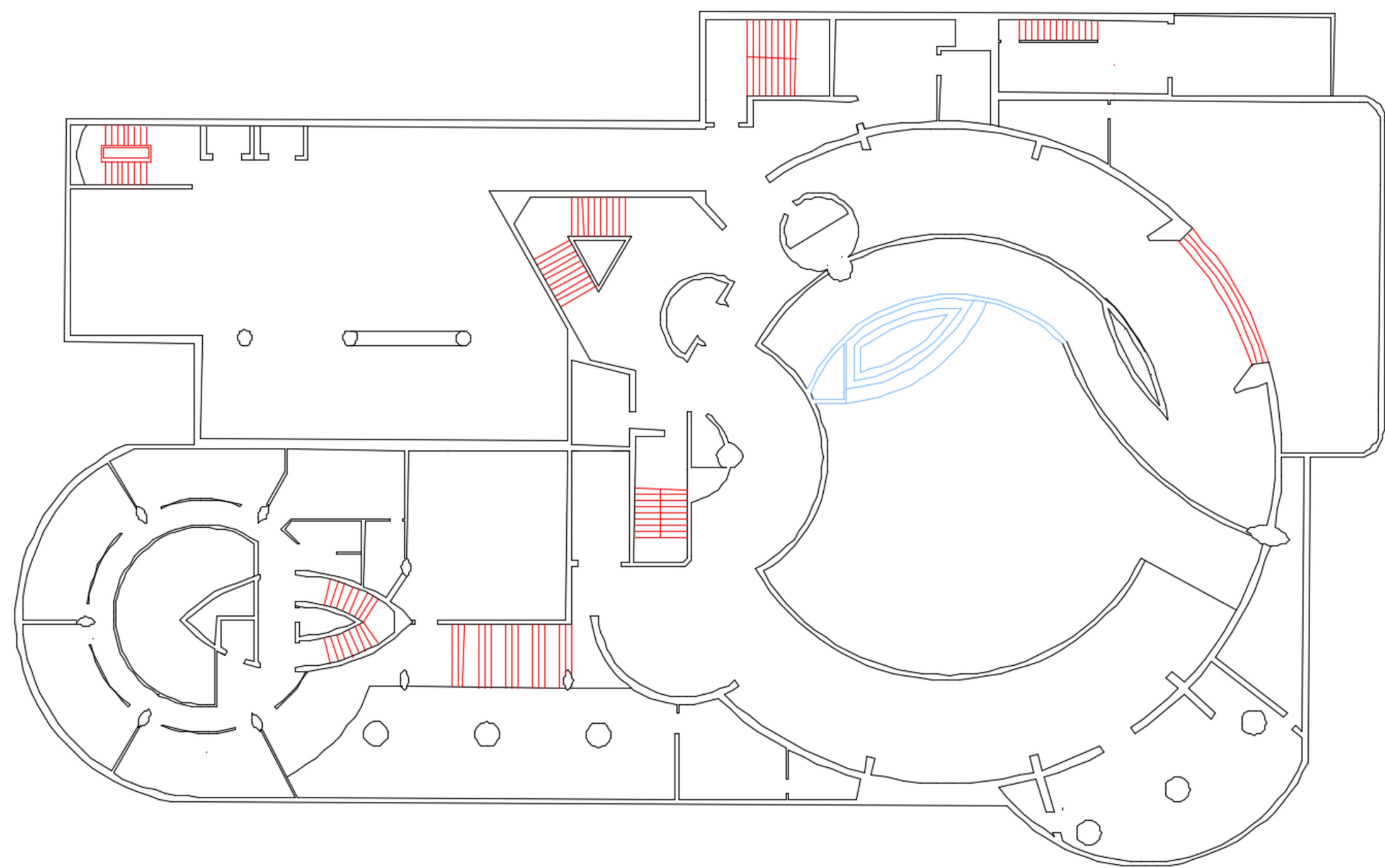

Pisos do Edifício \_ PISO 1



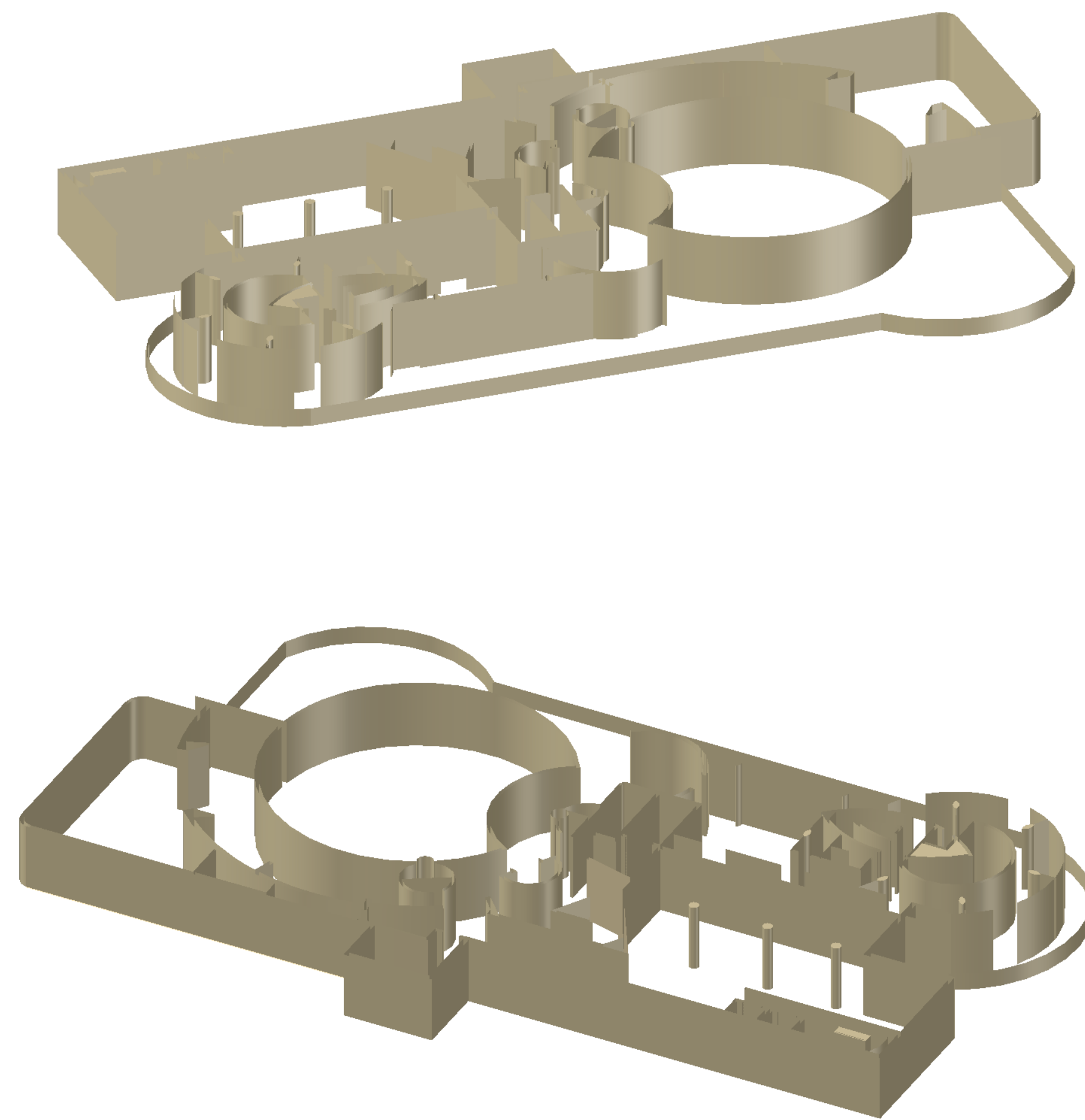
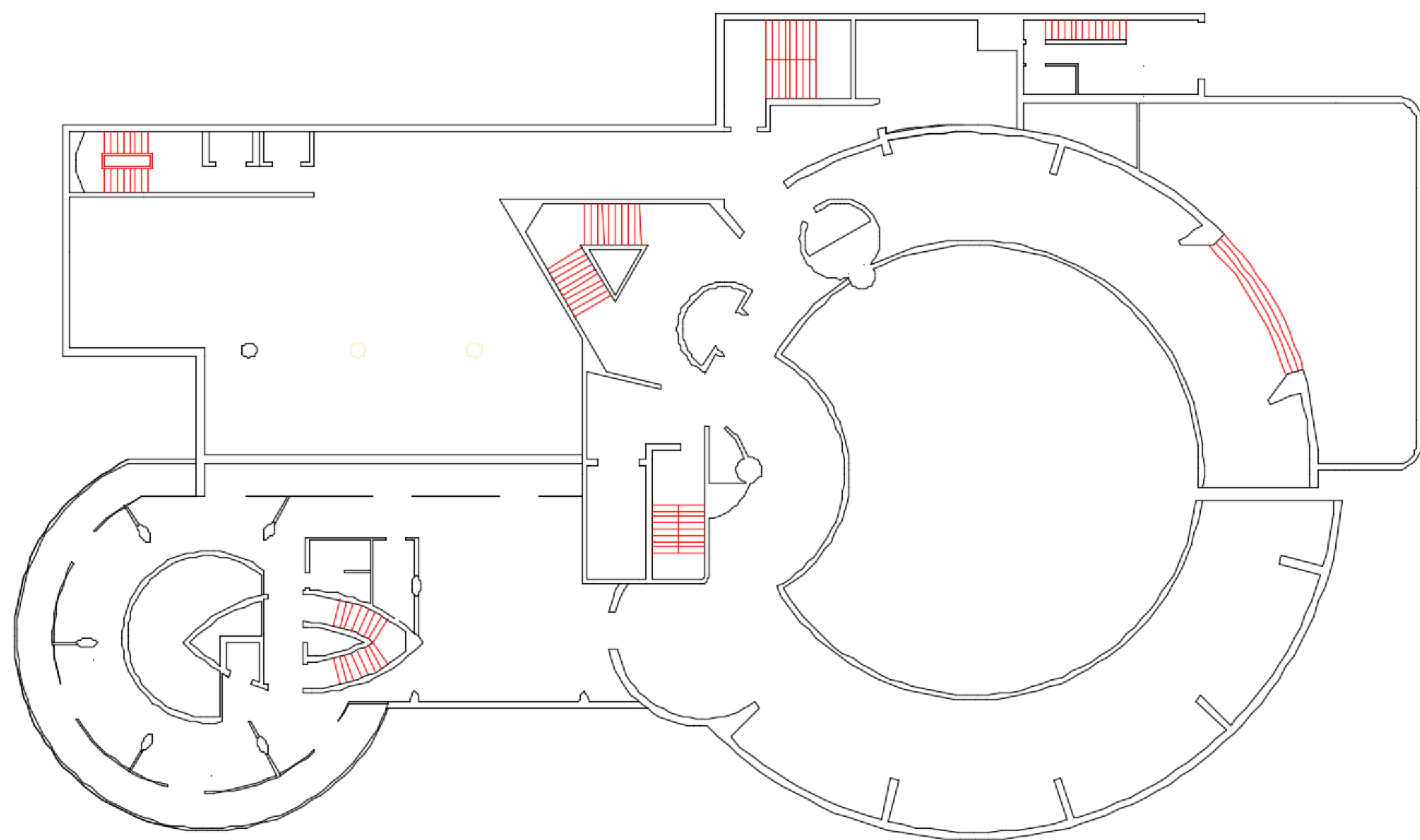

Pisos do Edifício \_ PISO 2

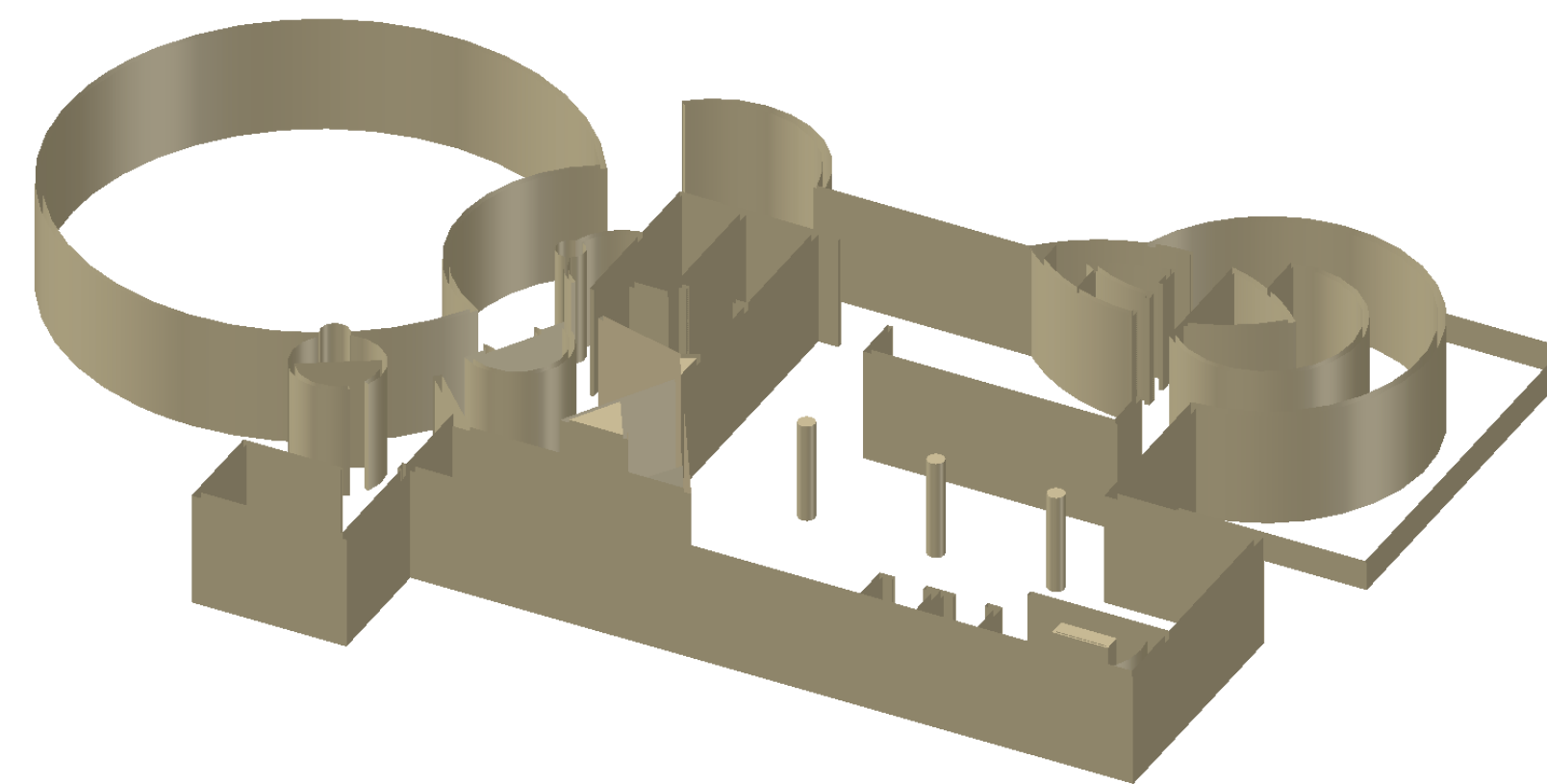
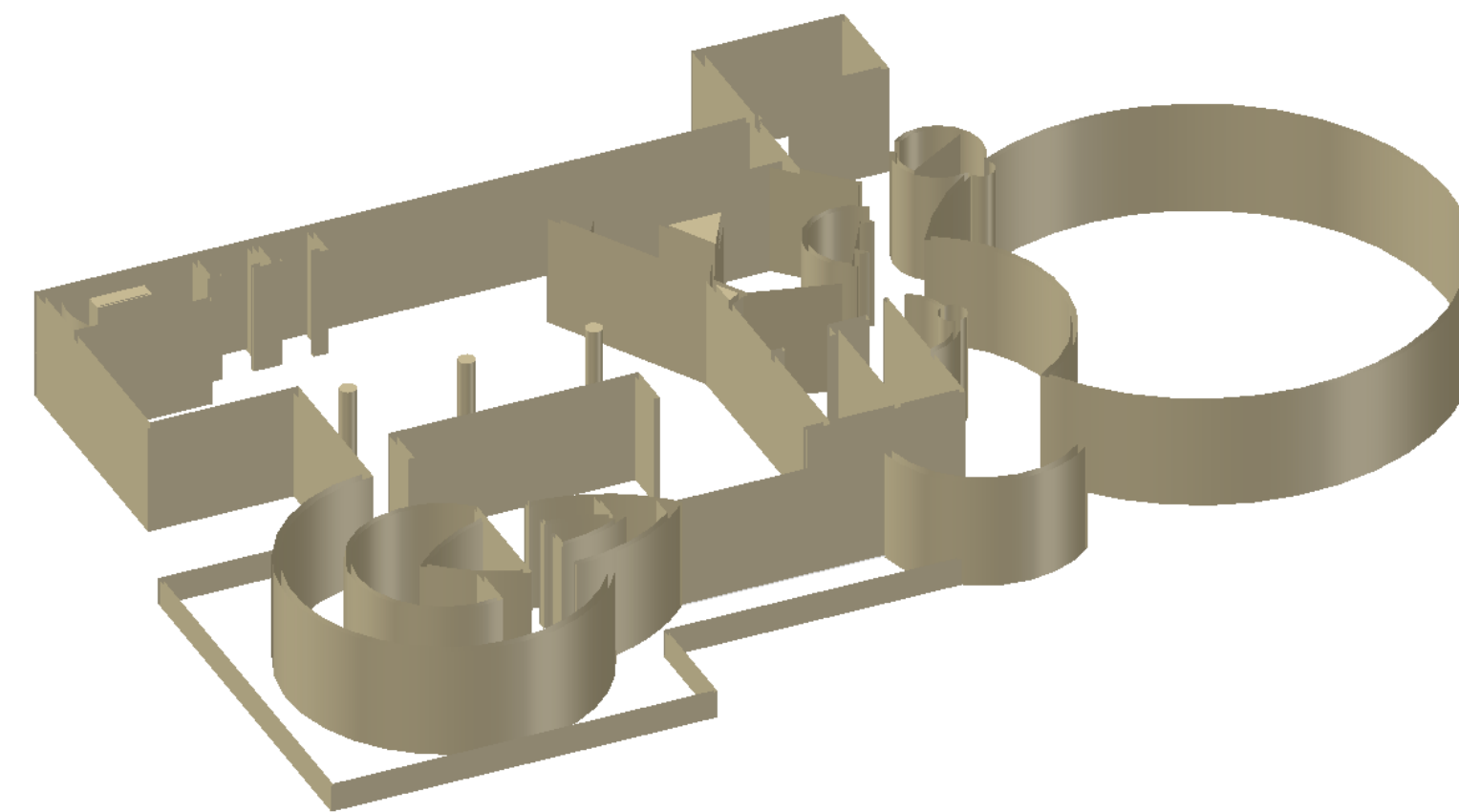
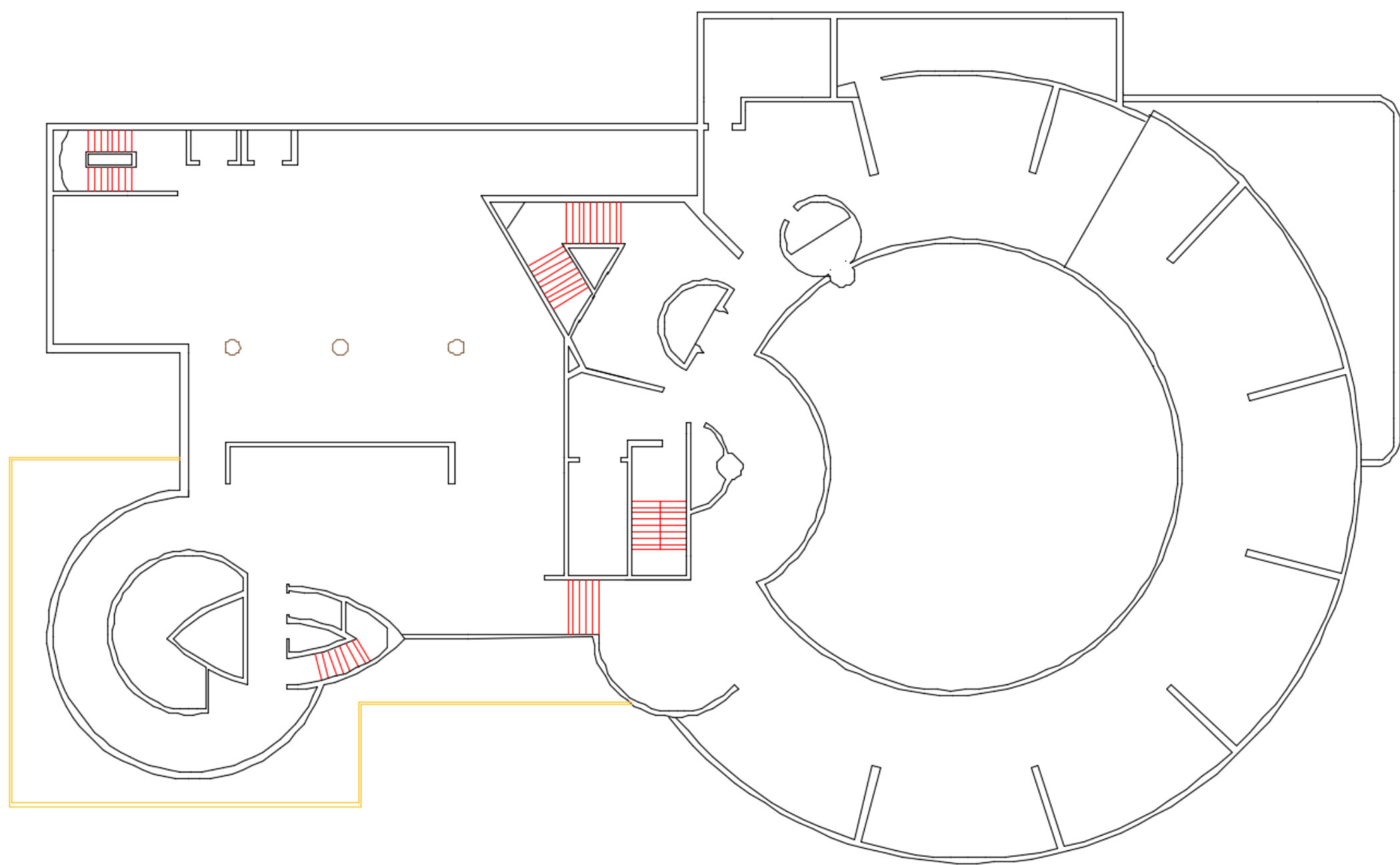

# Pisos do Edifício \_ PISO 3

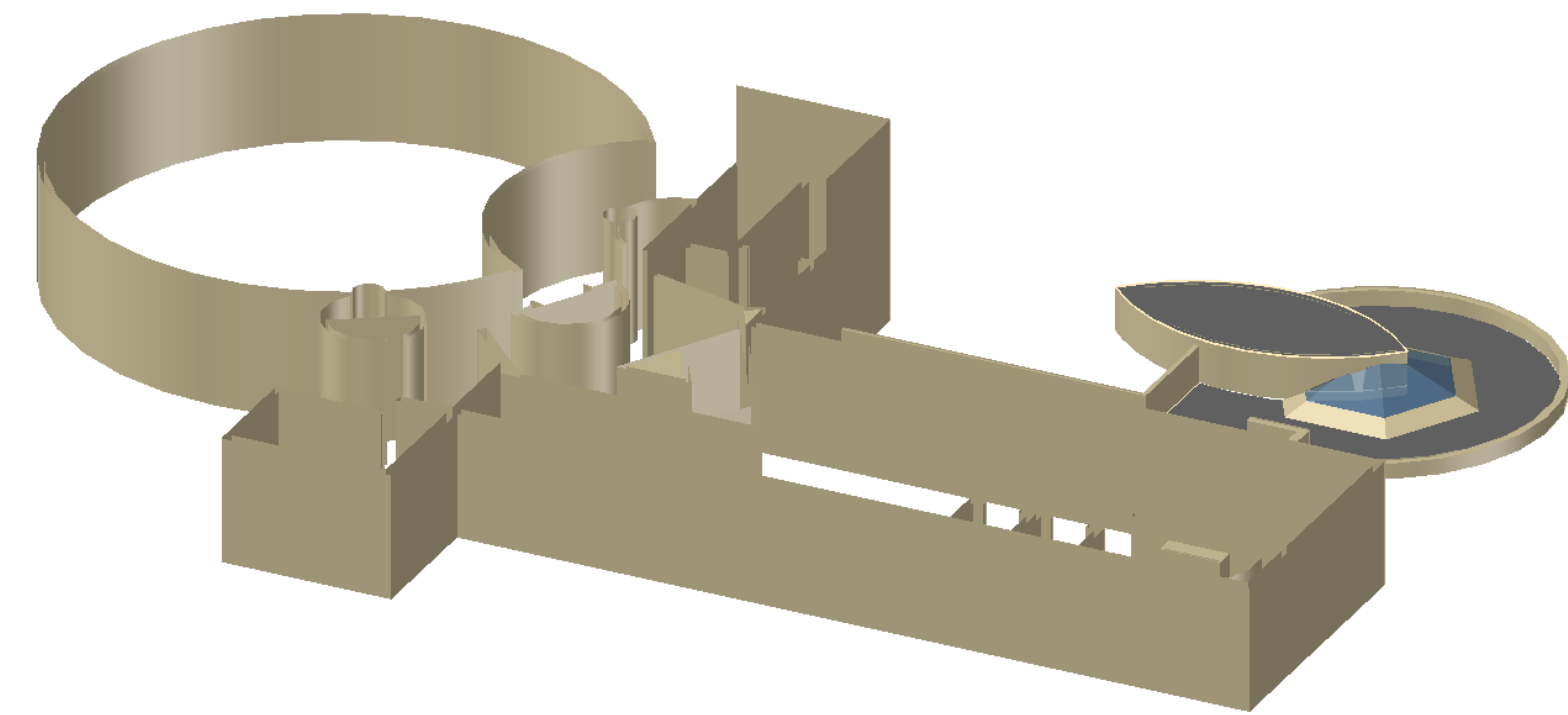
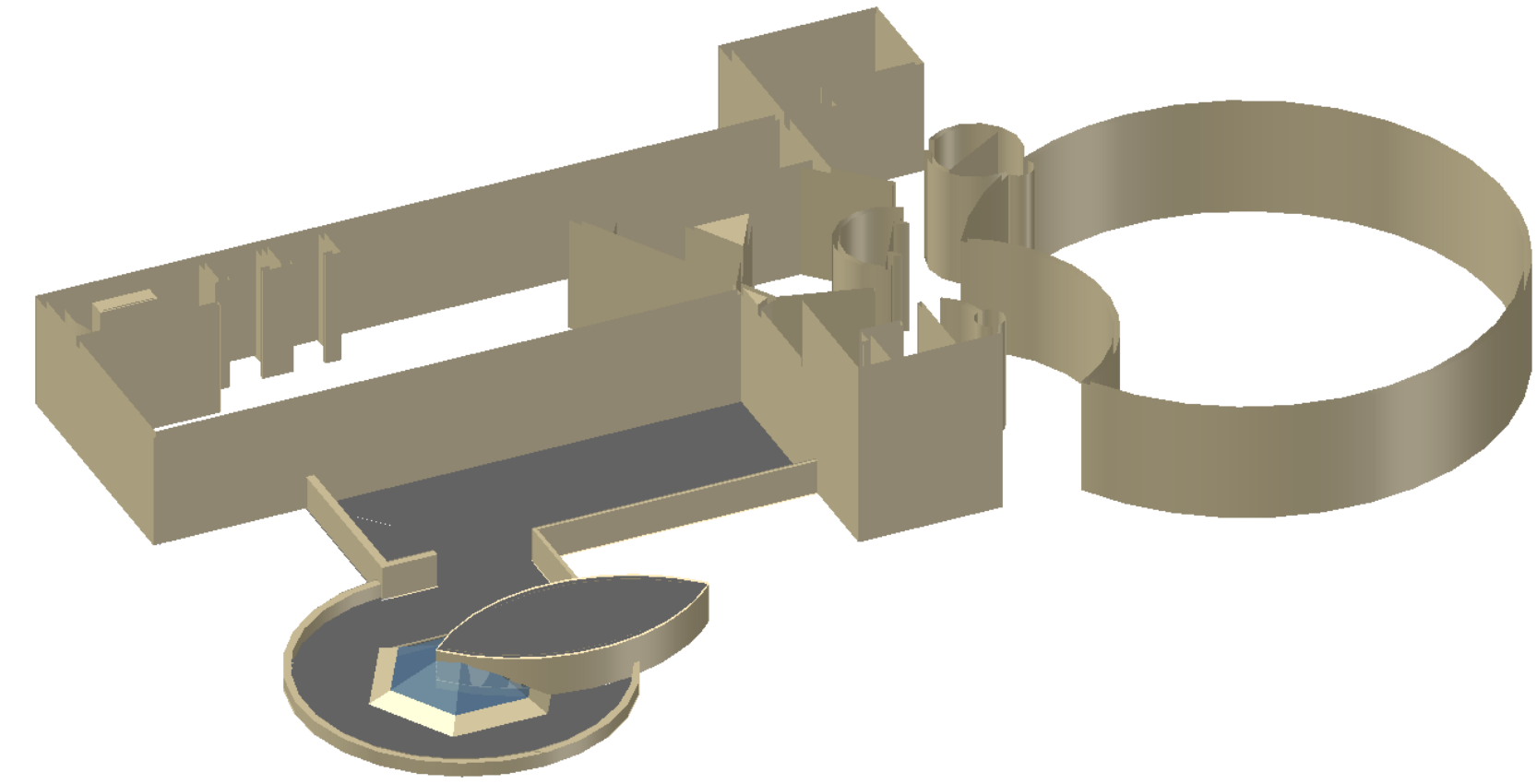
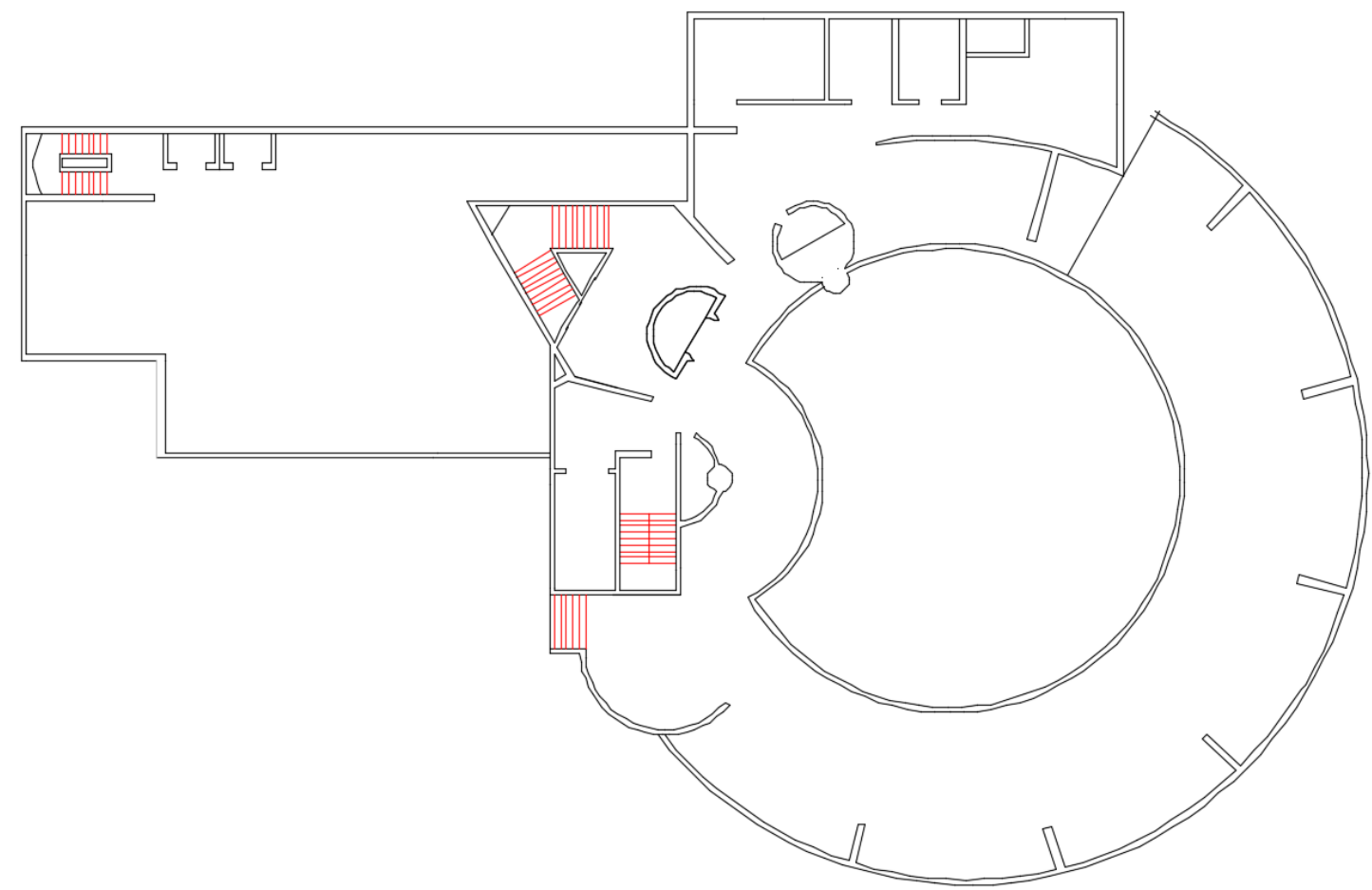
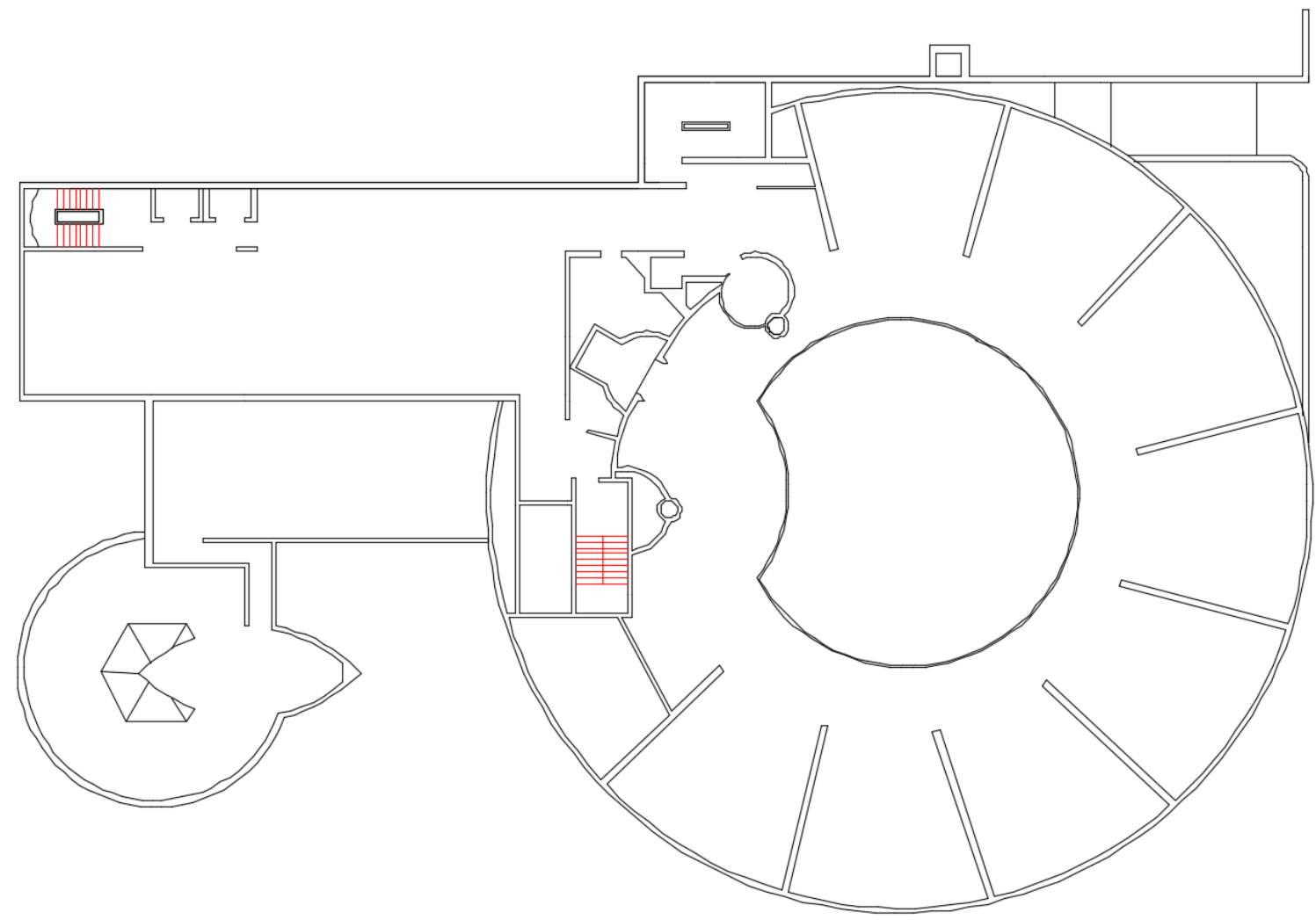

Pisos do Edifício \_ PISO 4

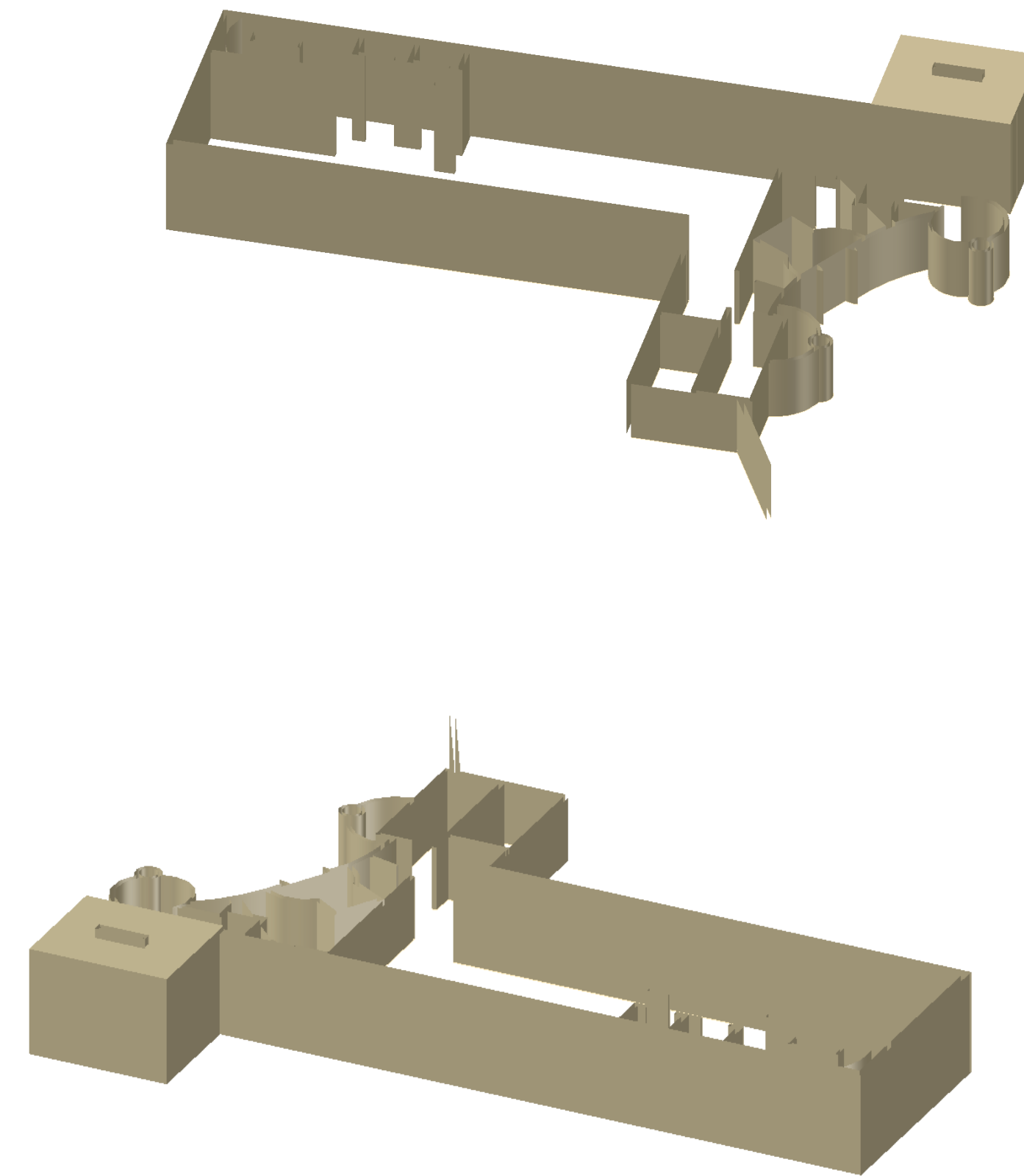
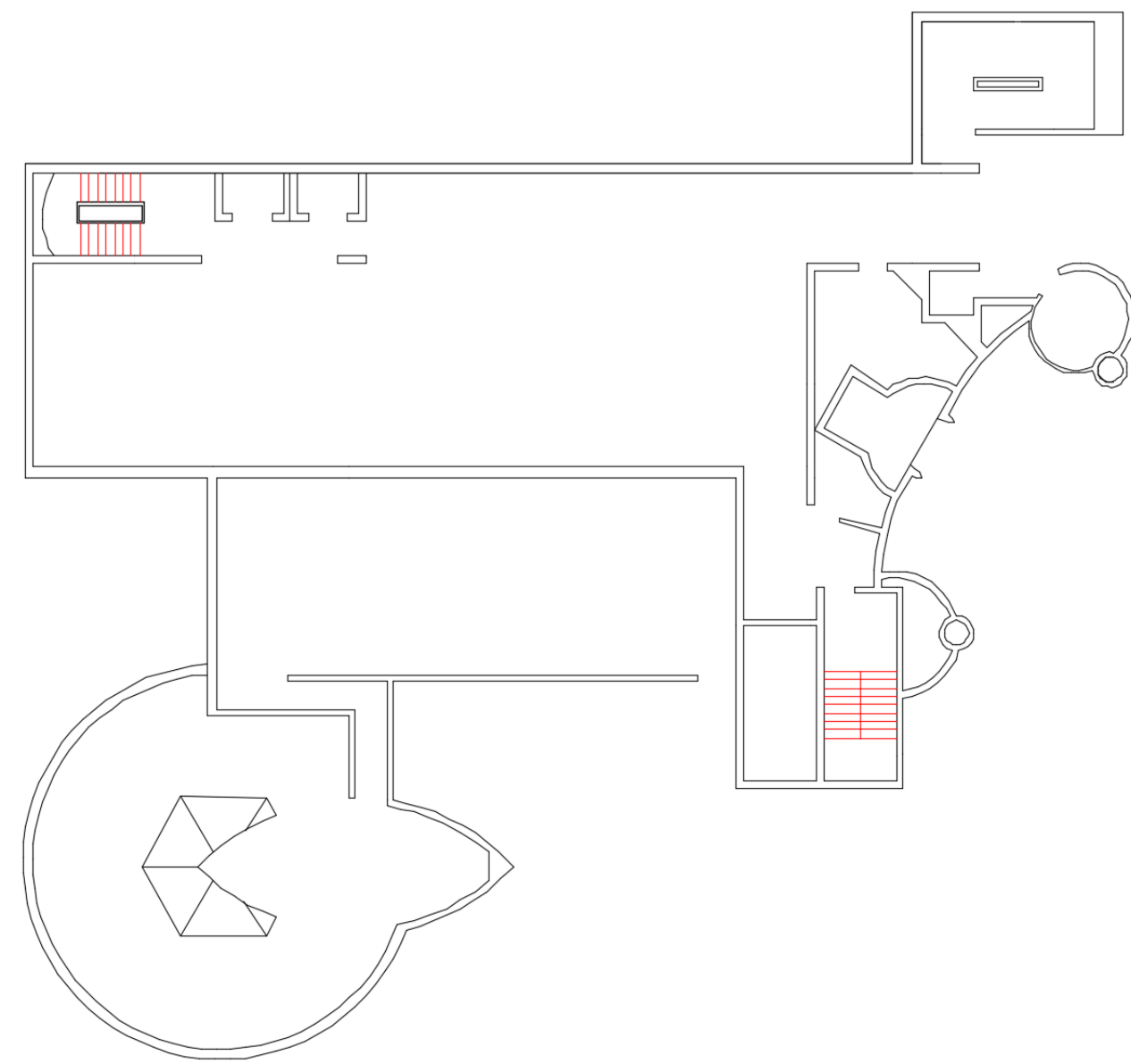

# Pisos do Edifício \_ PISO 5

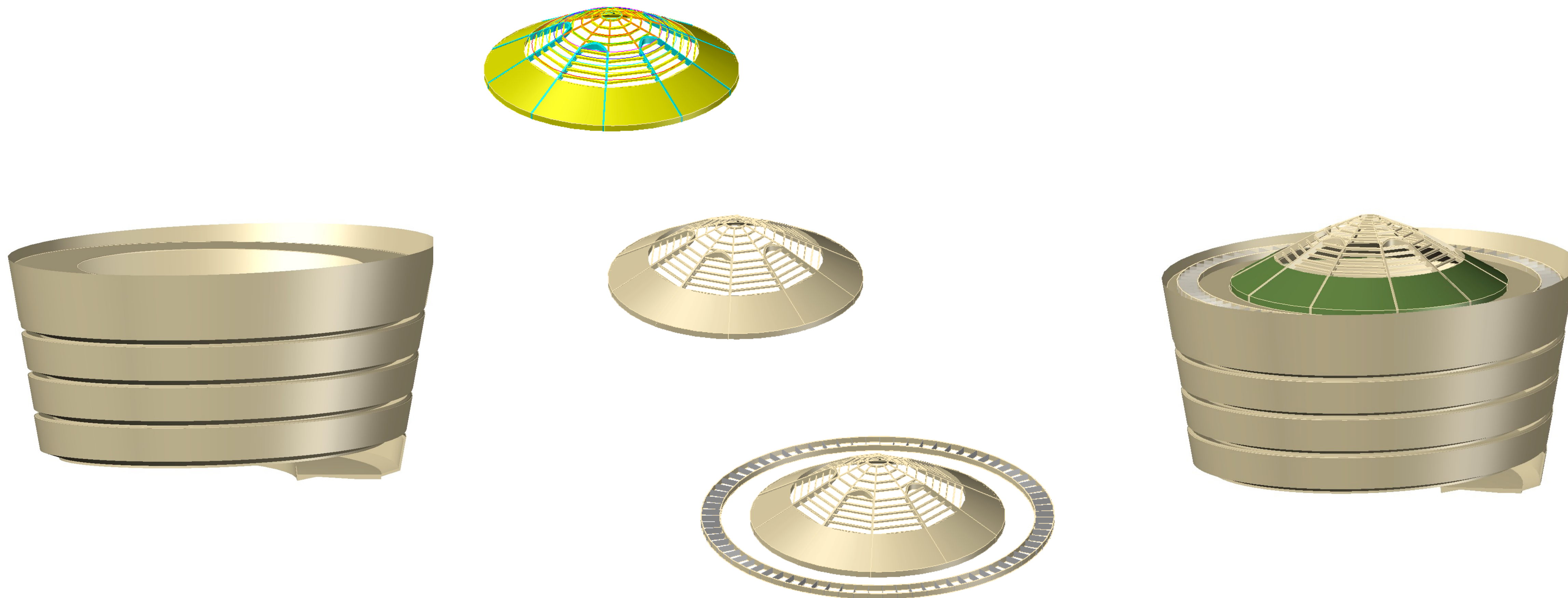

Pisos do Edifício \_ RAMPAS E COBERTURA

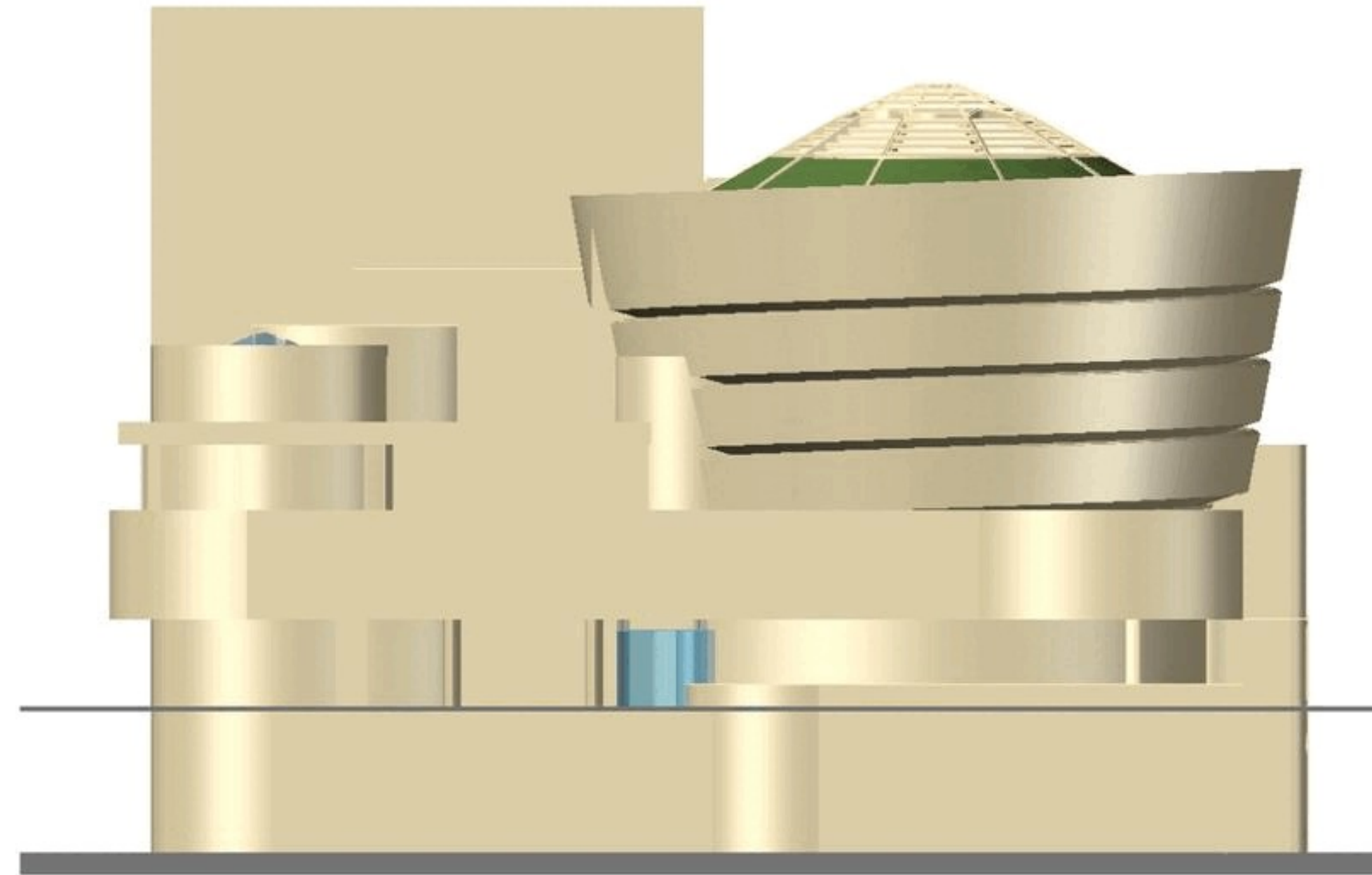

Modelo 3D \_GIF

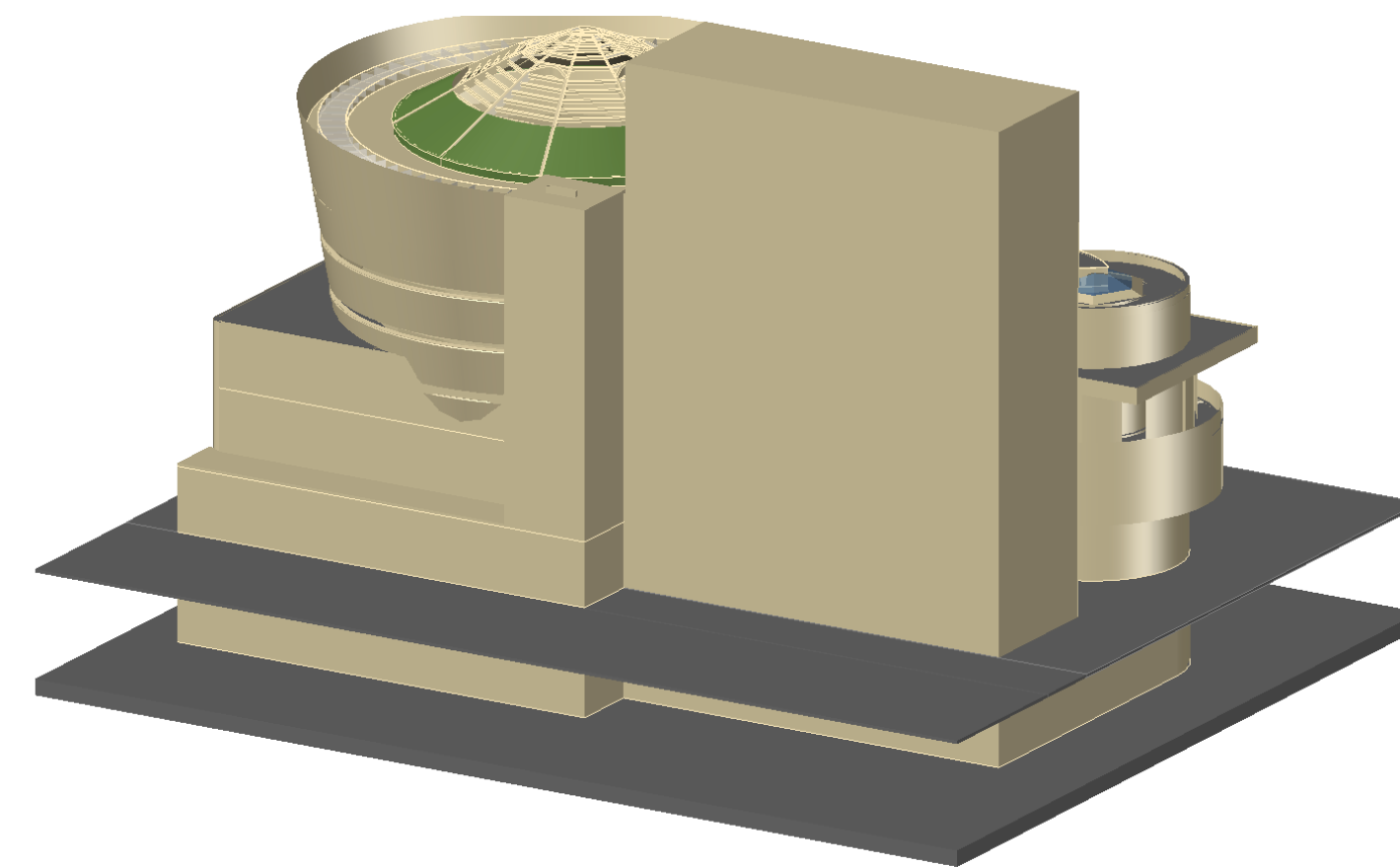
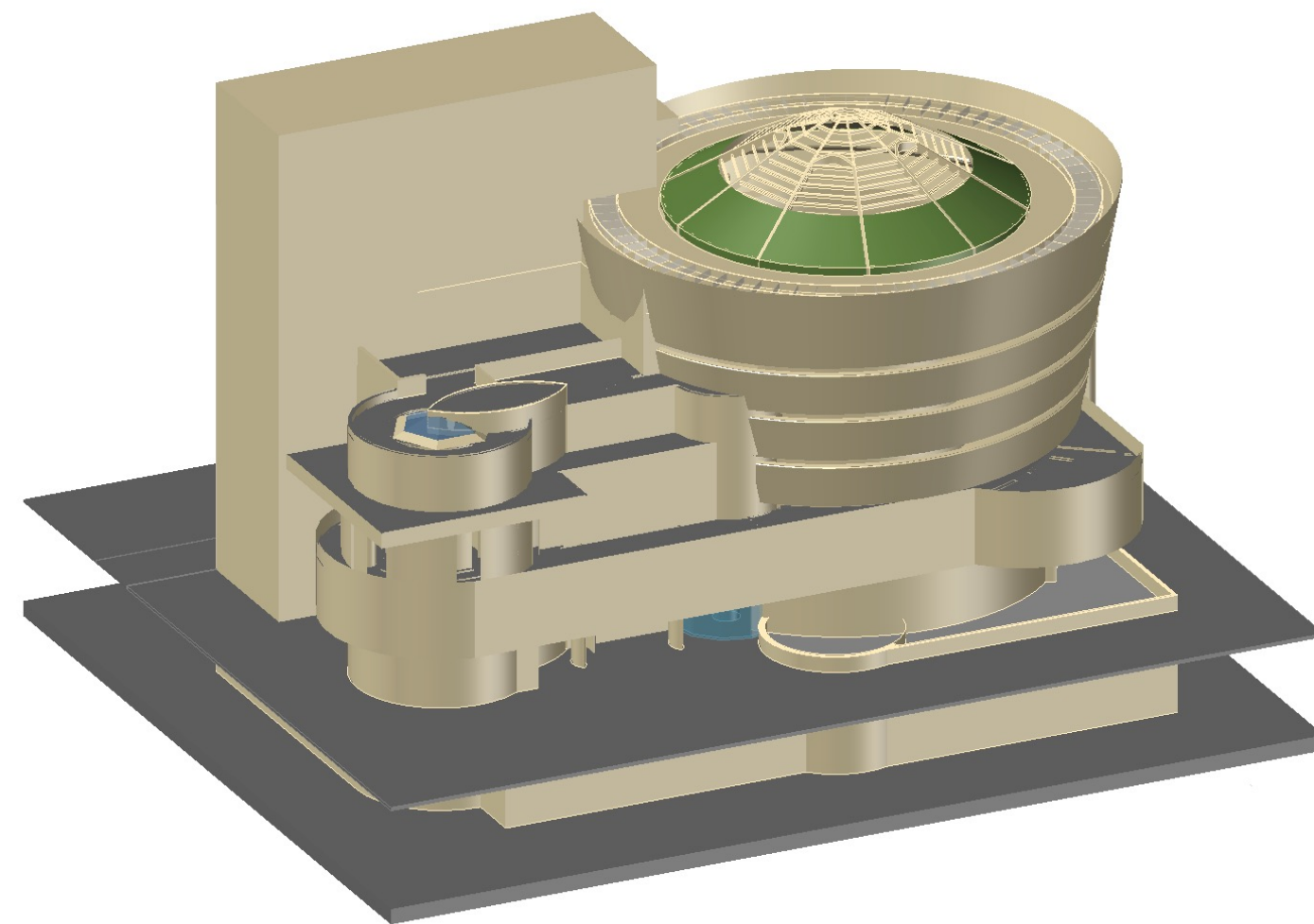
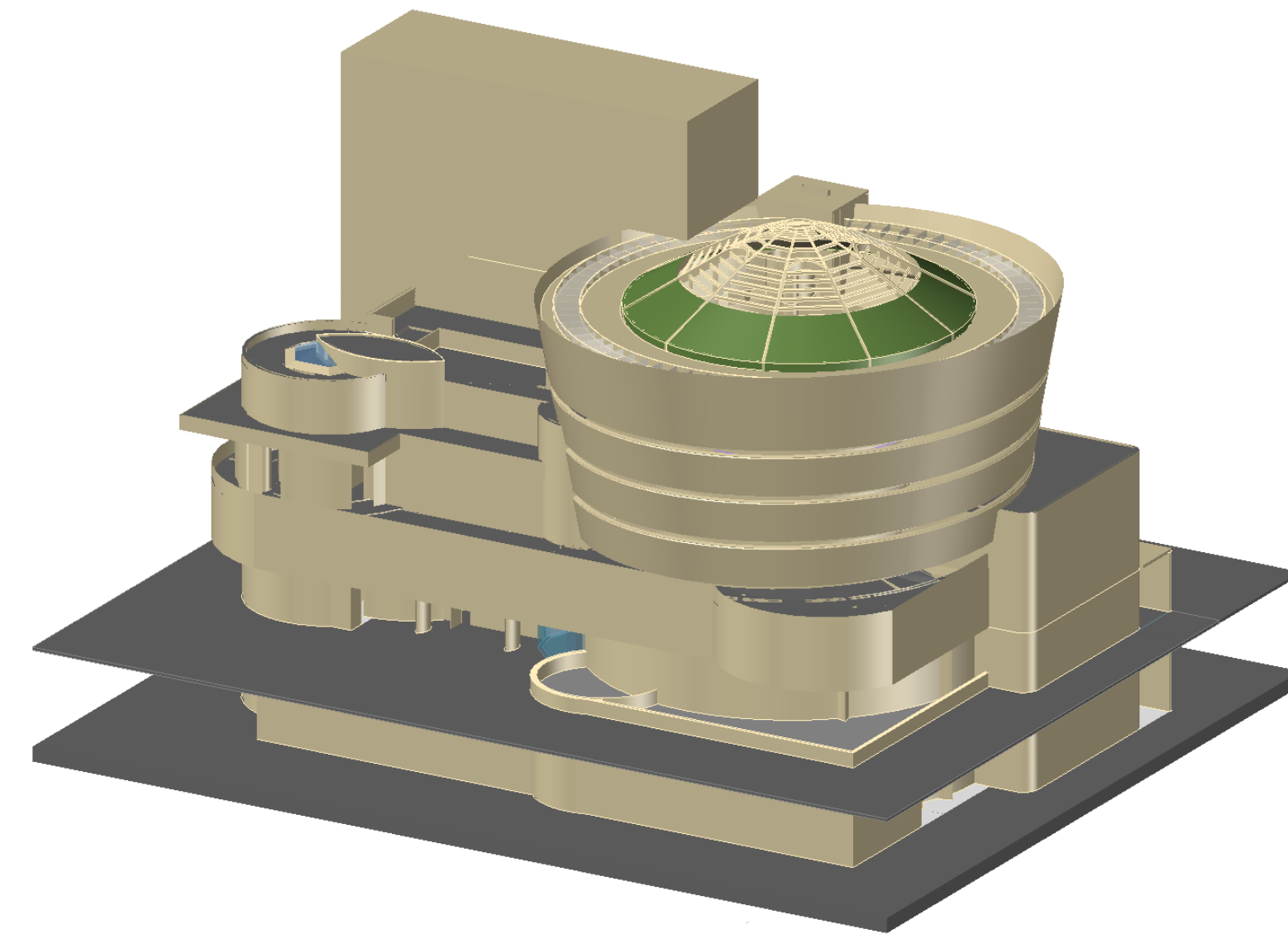
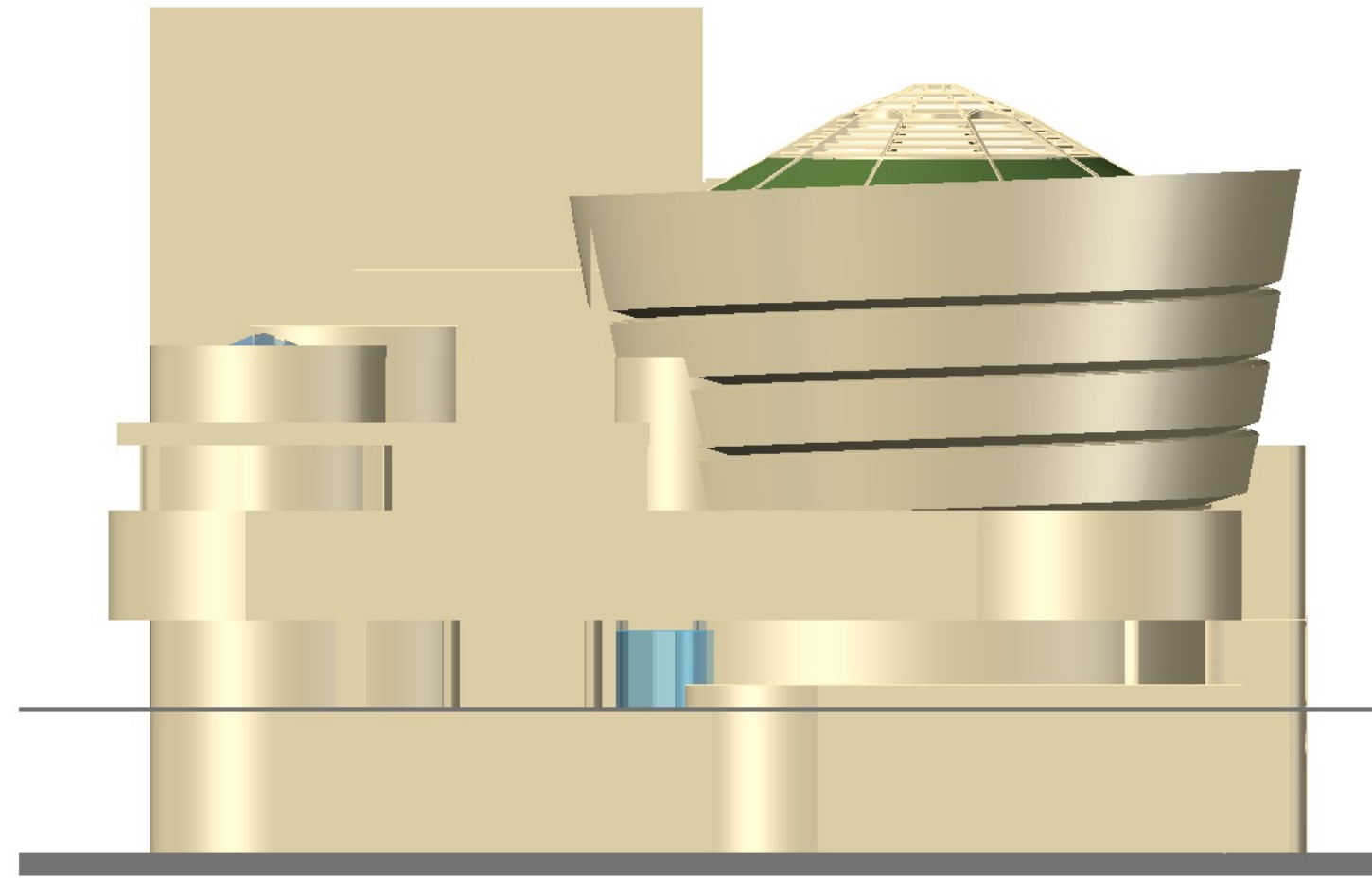

Modelo 3D

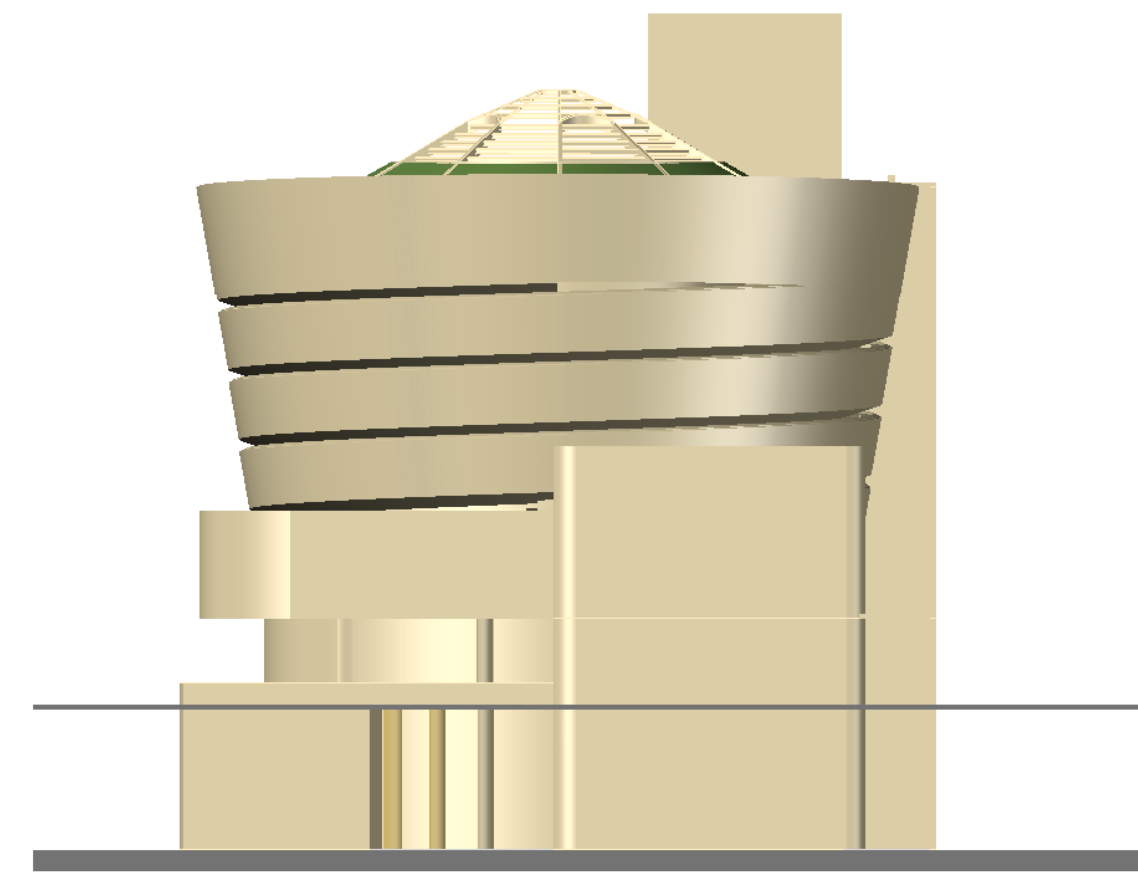
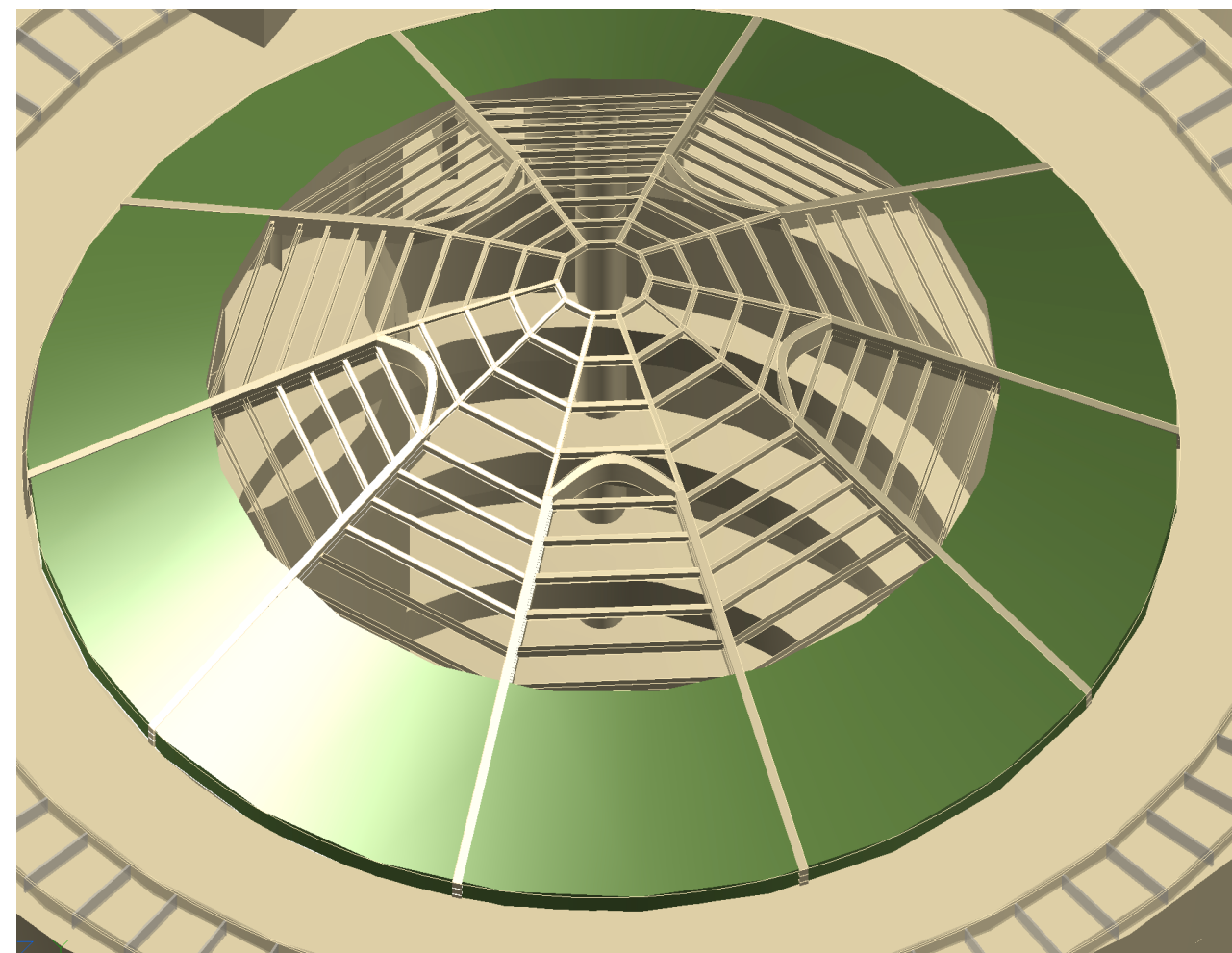
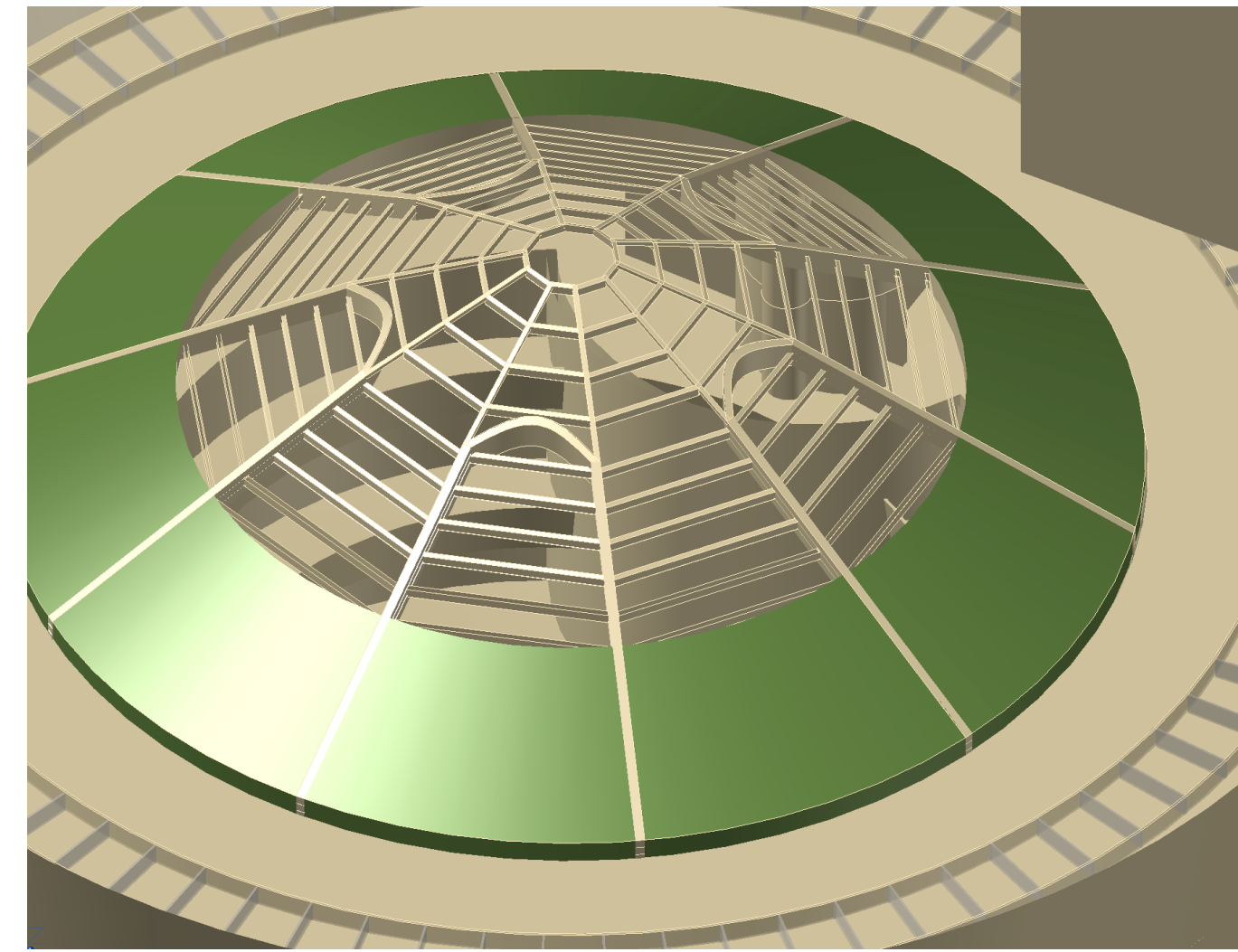
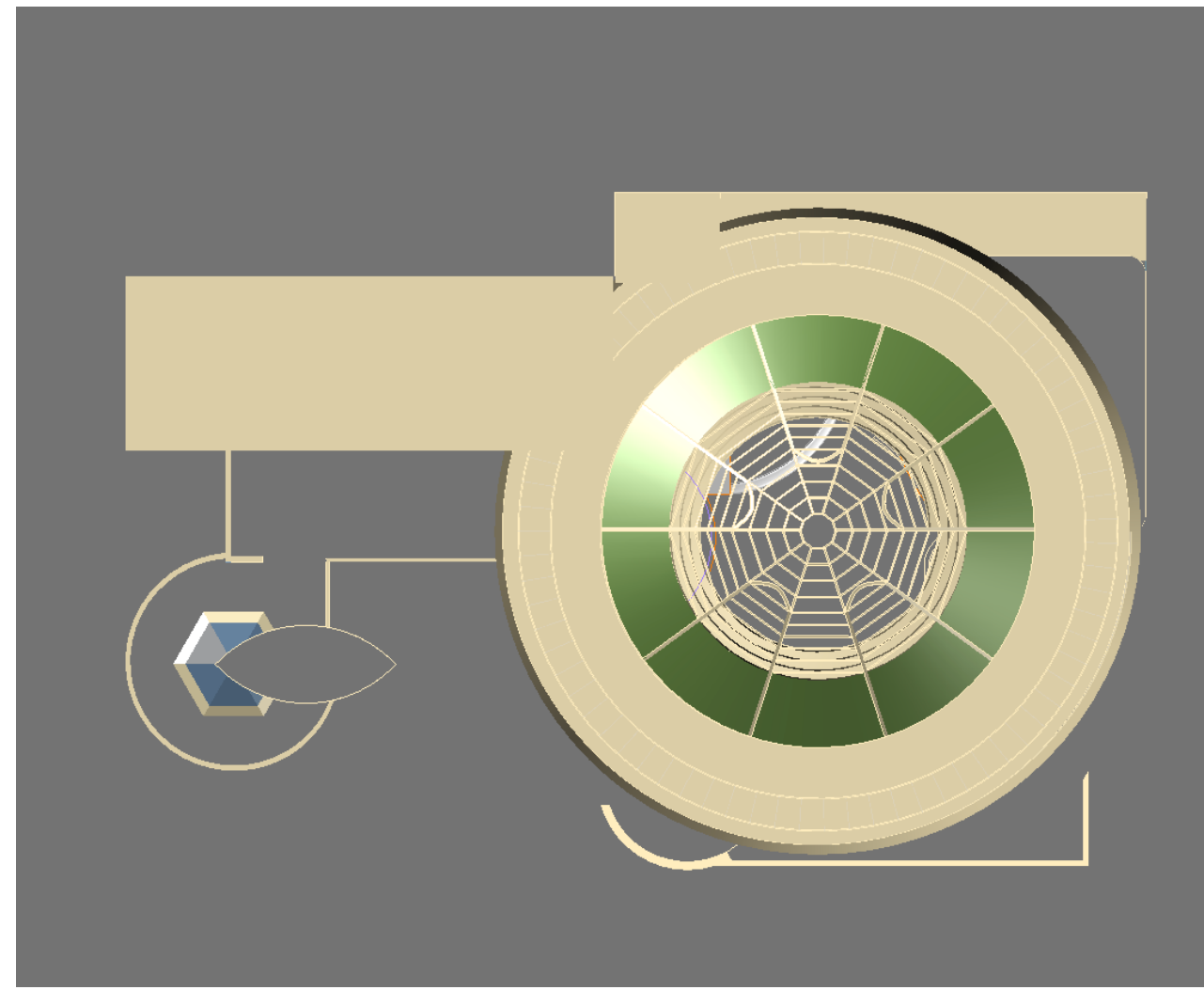

Modelo 3D