

Modelação e Visualização Tridimensional em Arquitectura

U LISBOA

UNIVERSIDADE
DE LISBOA

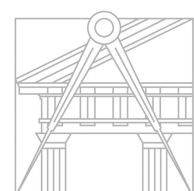

FACULDADE DE ARQUITETURA
UNIVERSIDADE DE LISBOA

Mestrado Integrado em Arquitectura
Ano Lectivo 2022-2023 2º Semestre
Docente - Nuno Alão 3º Ano

20201291



DANIELA SILVA

U LISBOA

UNIVERSIDADE
DE LISBOA

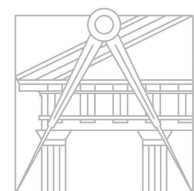

FACULDADE DE ARQUITETURA
UNIVERSIDADE DE LISBOA

MVTA

Mestrado Integrado em Arquitectura
Ano Lectivo 2022-2023 2º Semestre
Docente - Nuno Alão 3º Ano

ÍNDICE

- Exerc. 1.1 – Superfície Parabólica
- Exerc. 1.2 – Formas tridimensionais
- Exerc. 1.3 –Dualidades
- Exerc. 2.1–Cone - Secções
- Exerc. 2.2 –Superfícies de Revolução
- Exerc. 3 – AutoLisp – Xadrez
- Exerc. 4.1 – Parabolóide Hiperbólico
- Exerc. 4.2 – Superfícies - LOFT

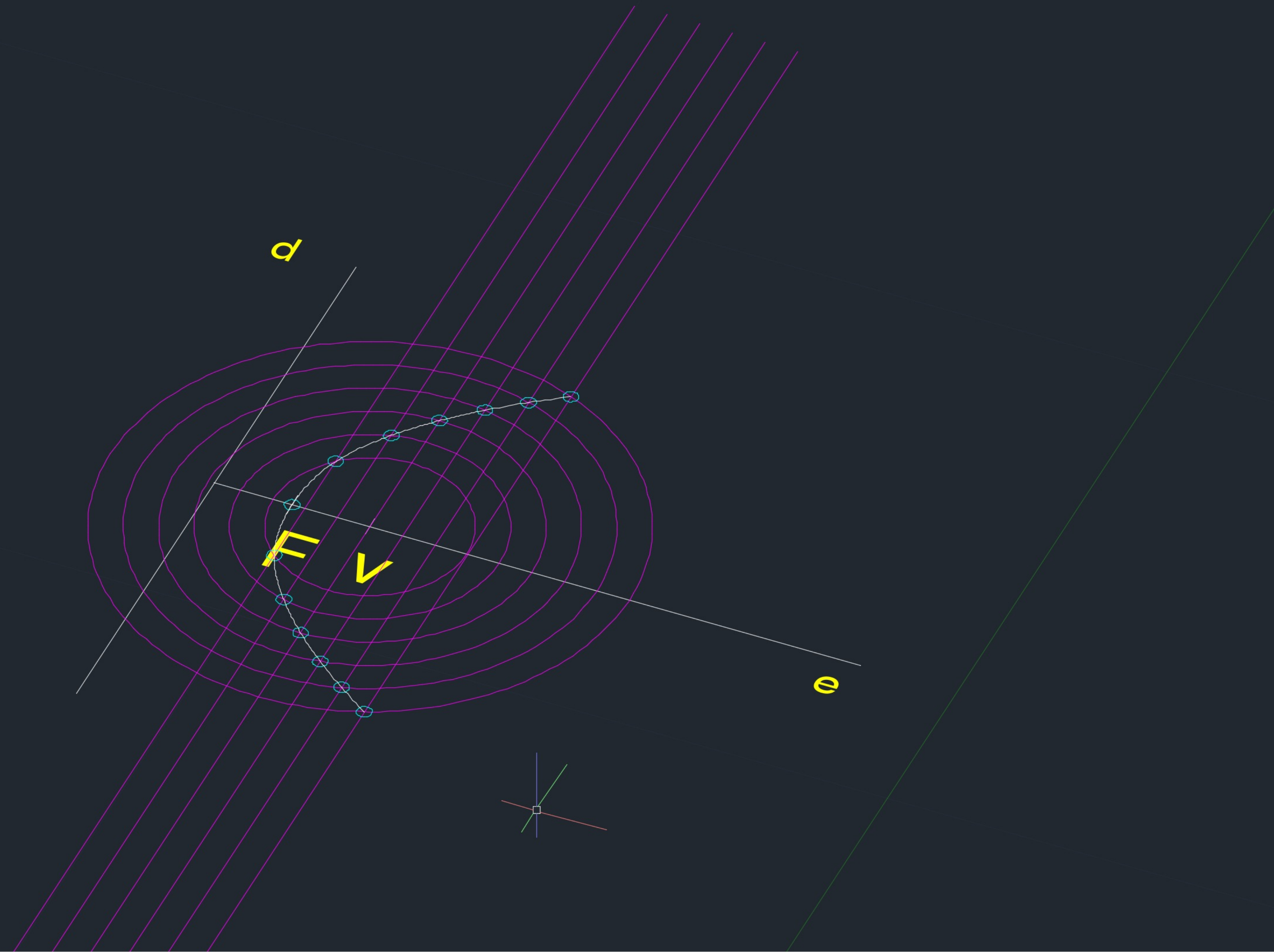

Exerc. 1.1 – Superfície Parabólica

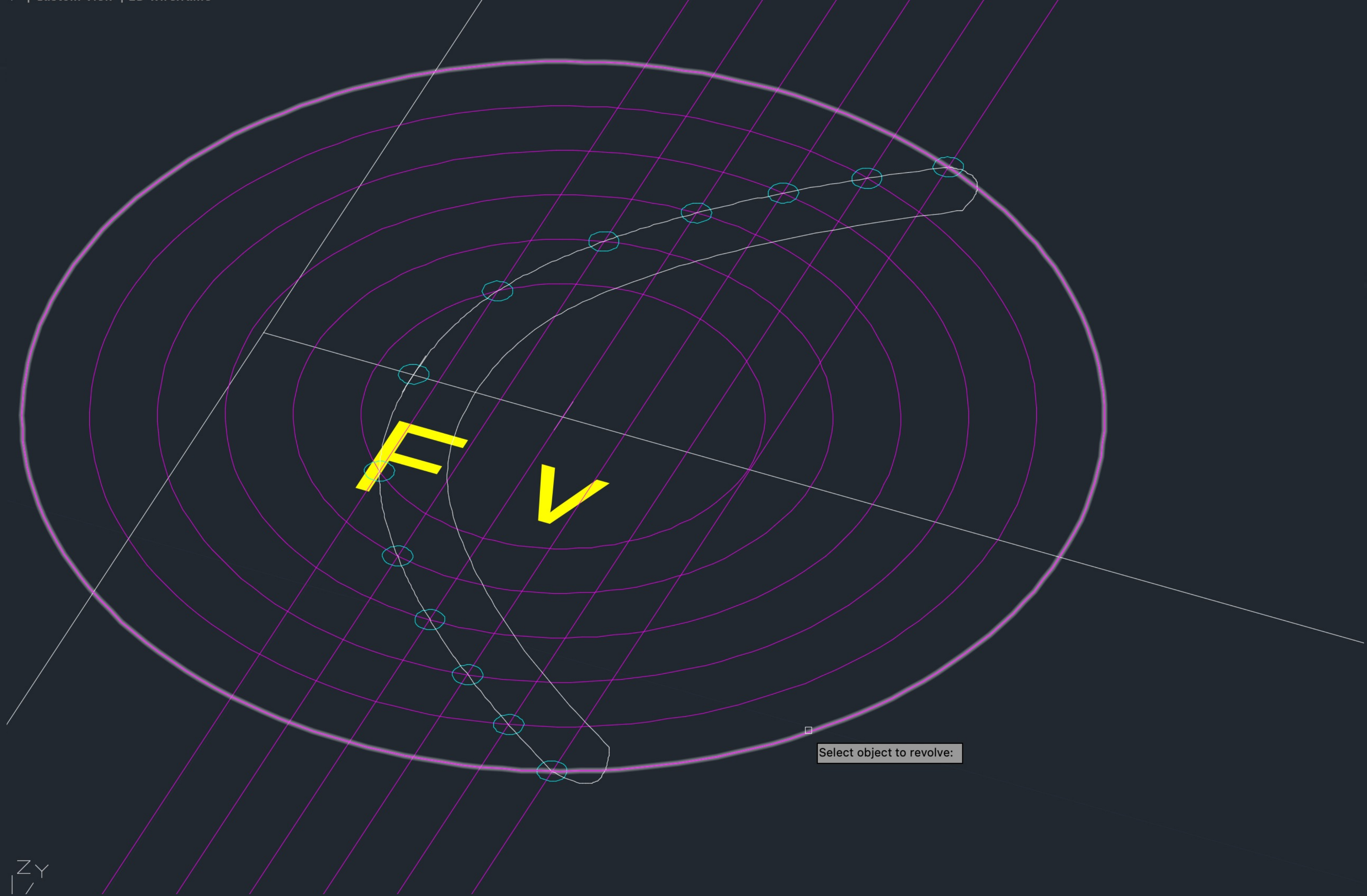

Exerc. 1.1 – Superfície Parabólica

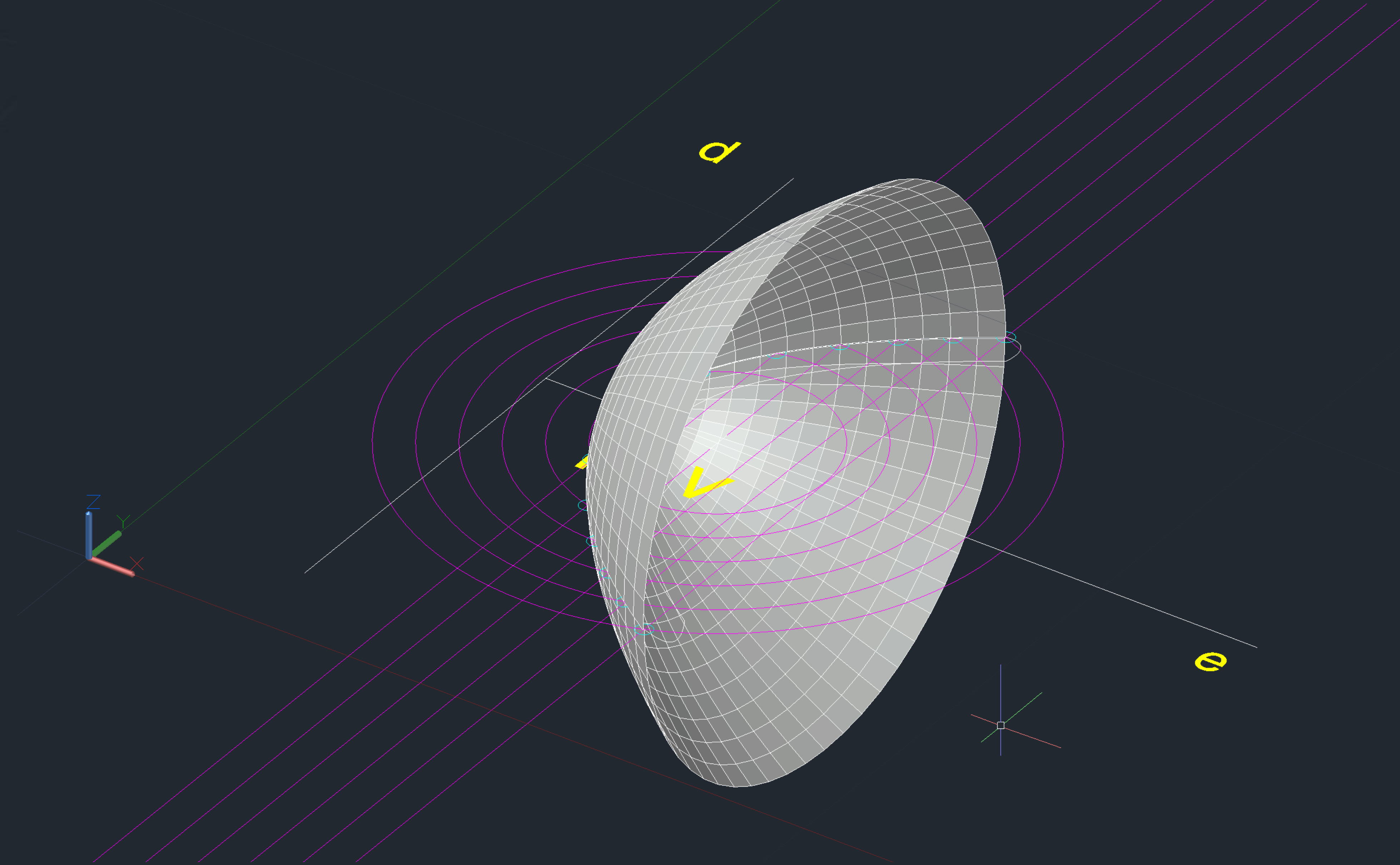

Exerc. 1.1 – Superfície Parabólica

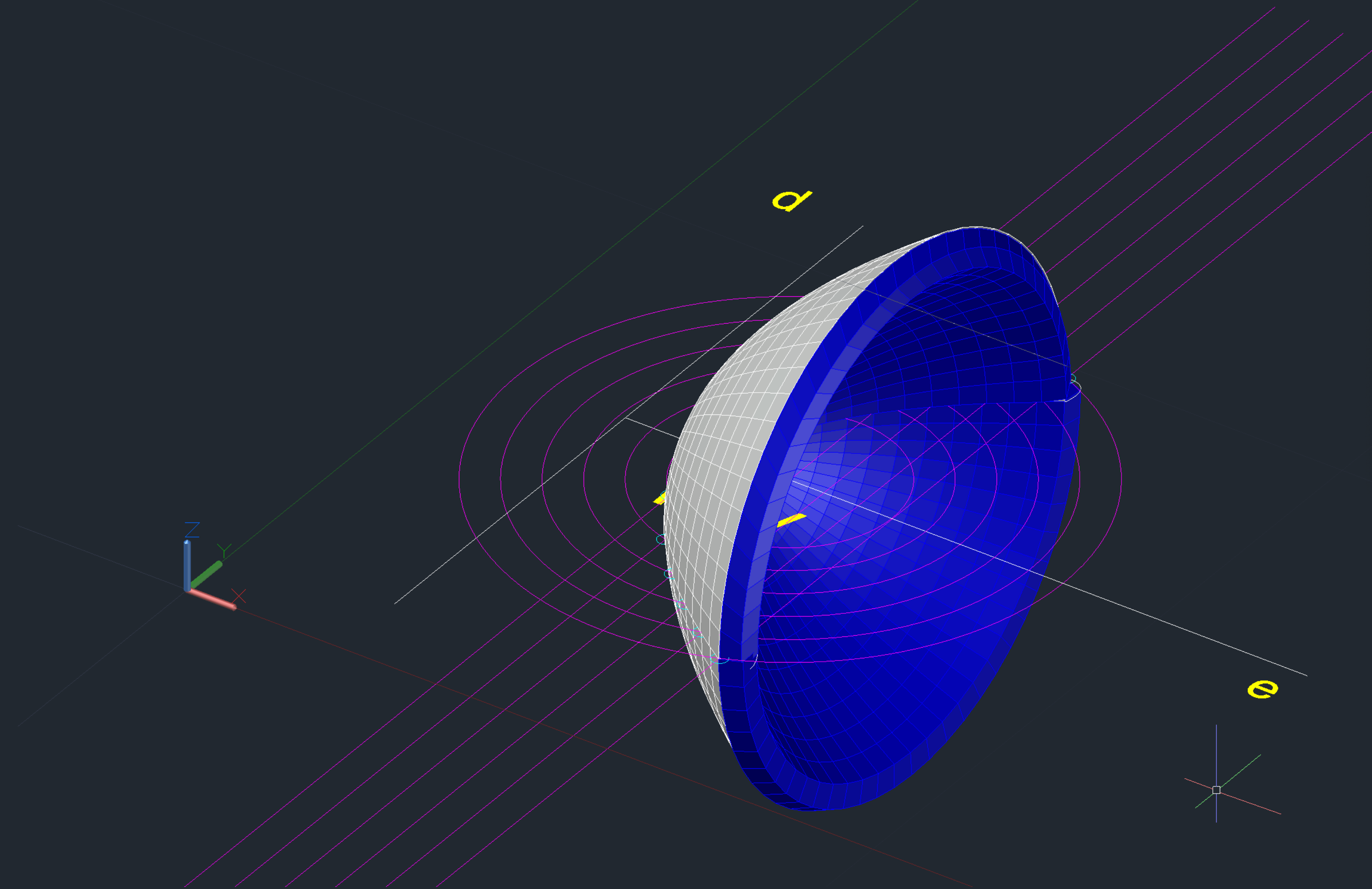

Exerc. 1.1 – Superfície Parabólica

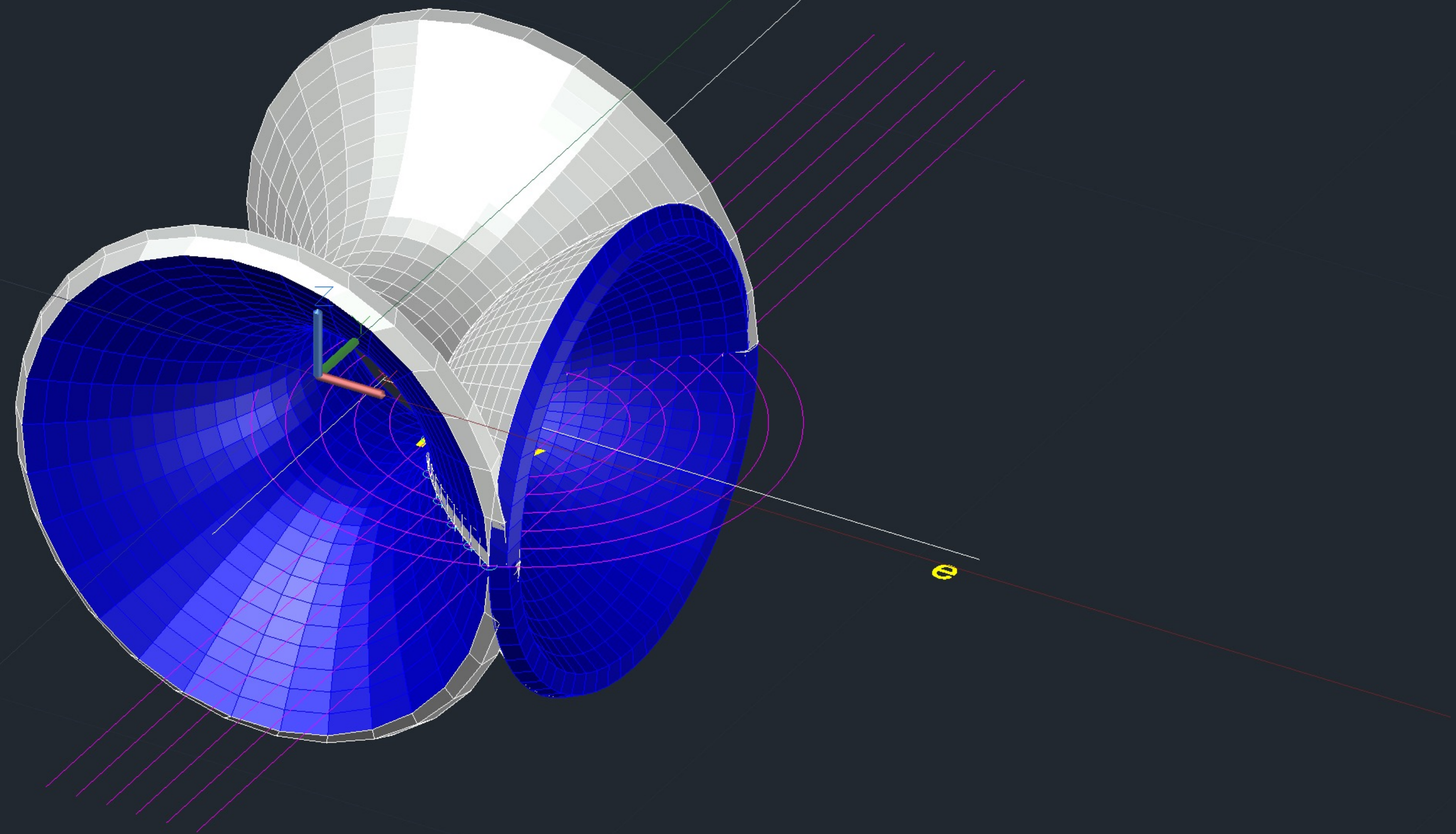

Exerc. 1.1 – Superfície Parabólica

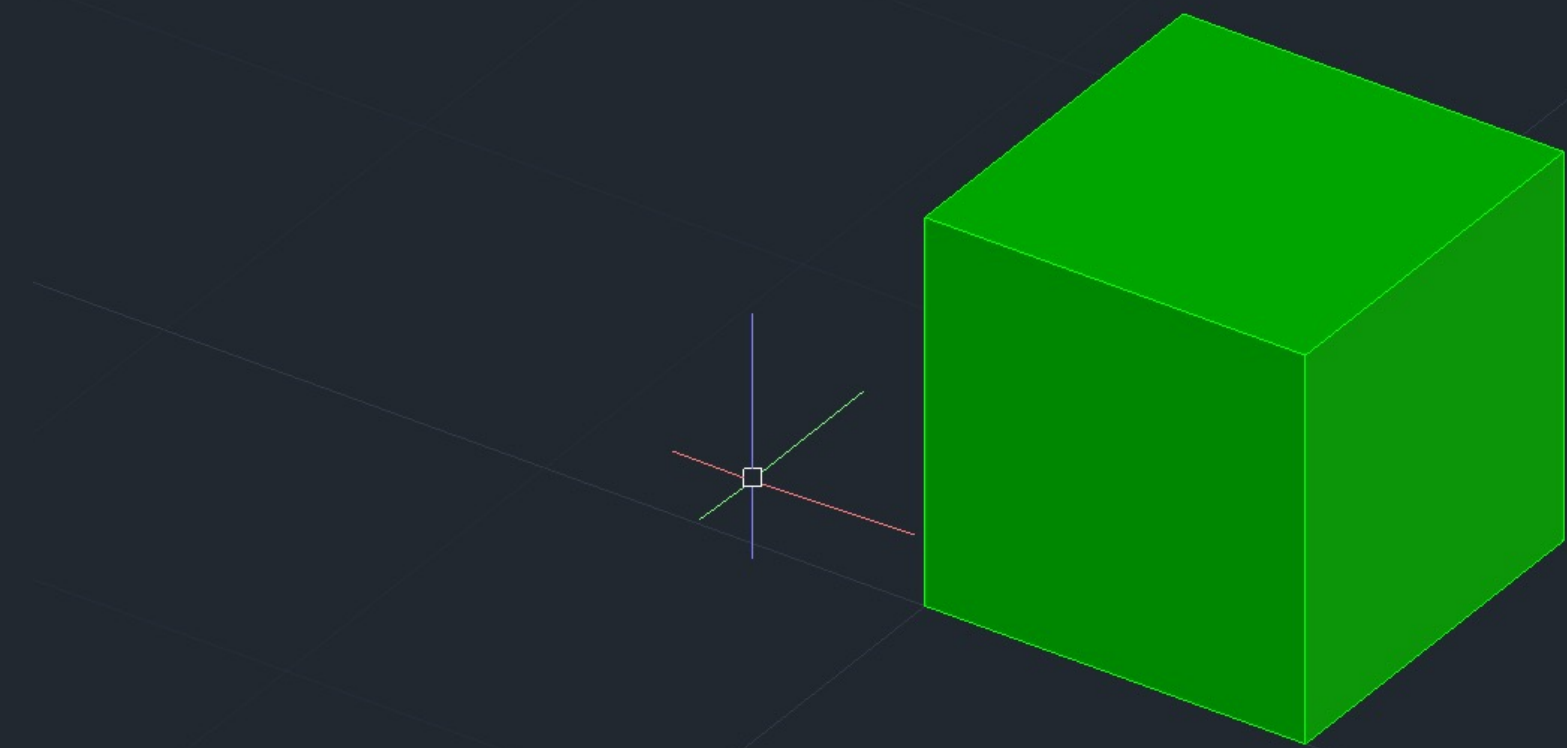

BOX

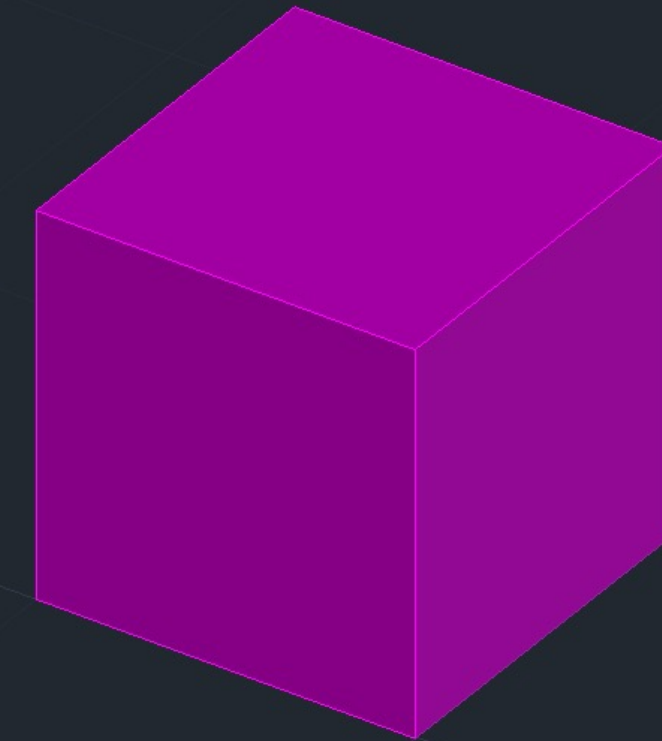

EXTRUDE



Exerc. 1.2 – Formas Tridimensionais

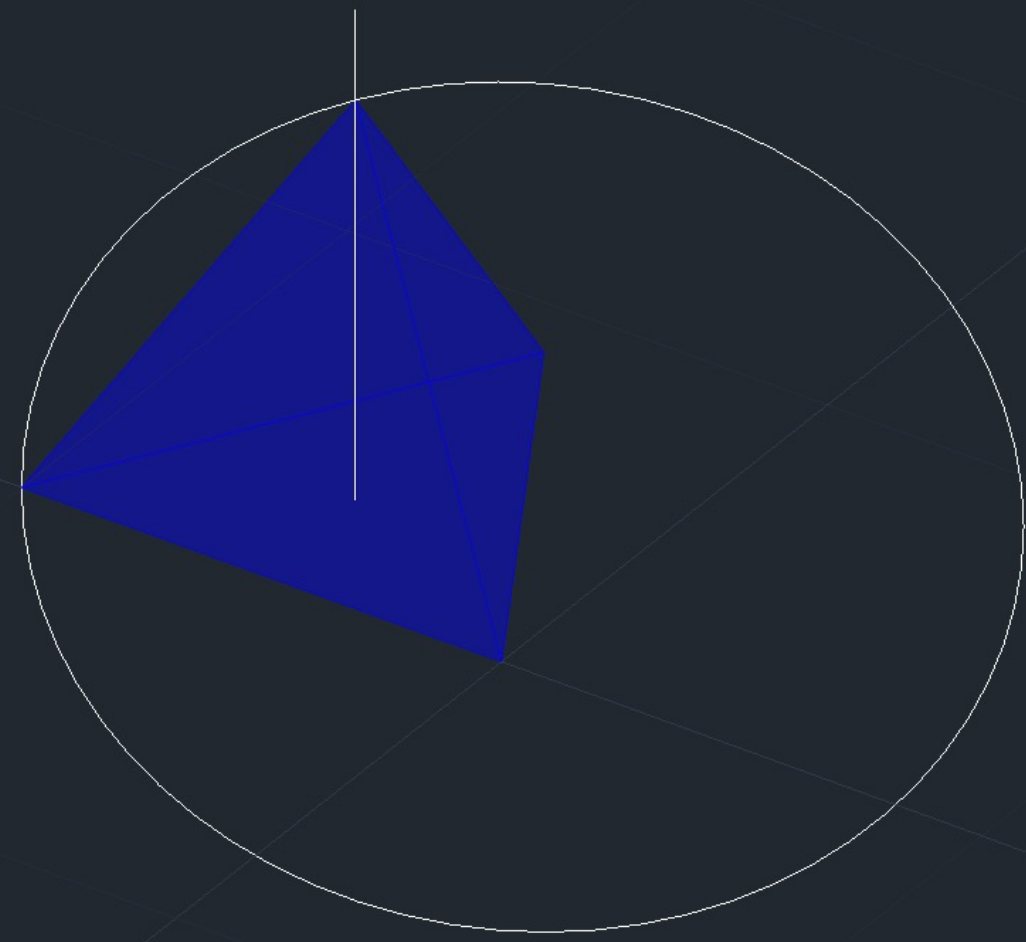

TETRAEDRO

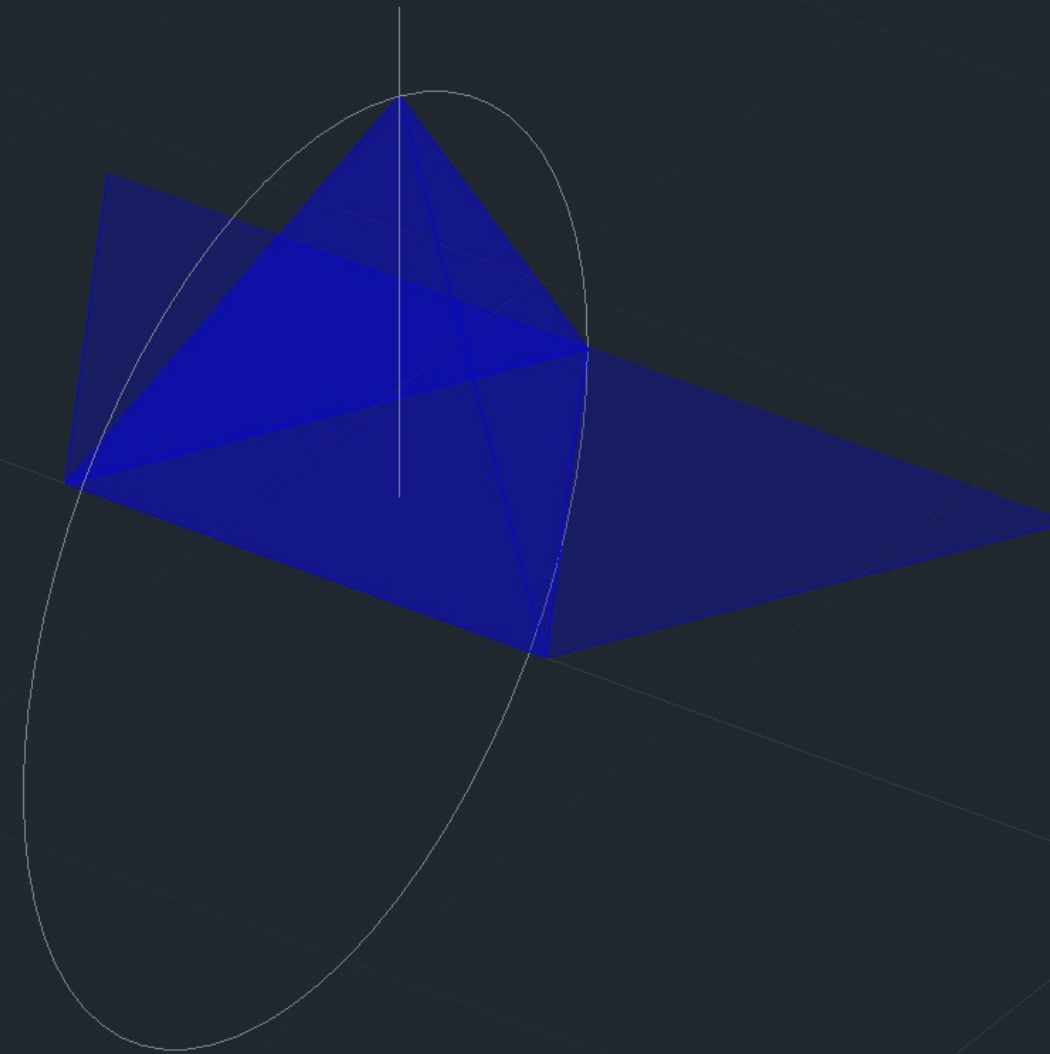
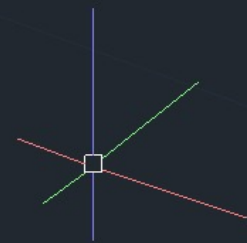

TETRAEDRO

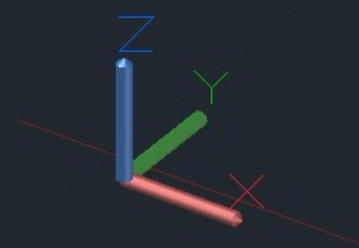

Exerc. 1.2 – Formas Tridimensionais

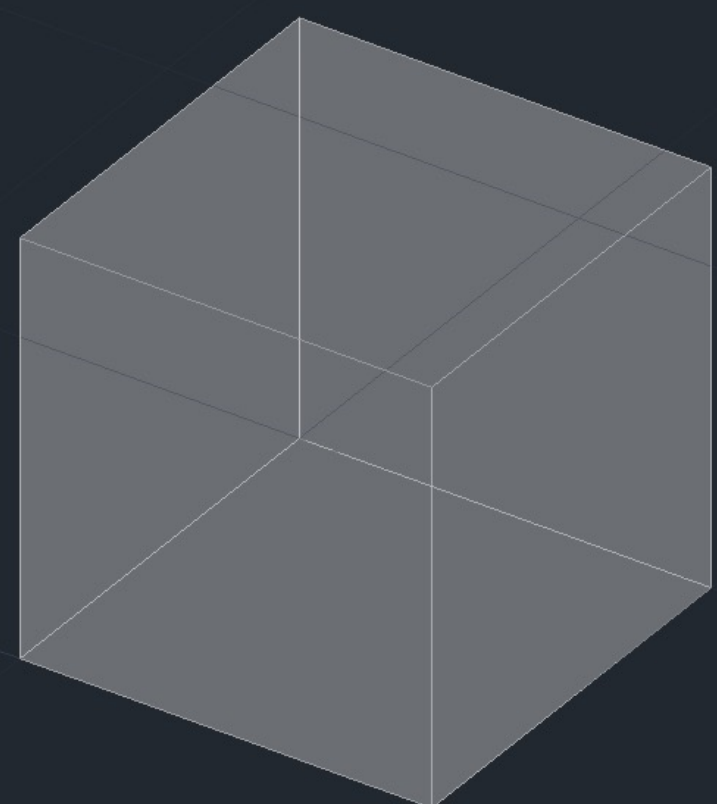

HEXAEDRO

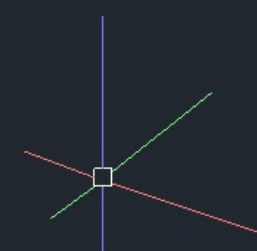

HEXAEDRO



Exerc. 1.2 – Formas Tridimensionais

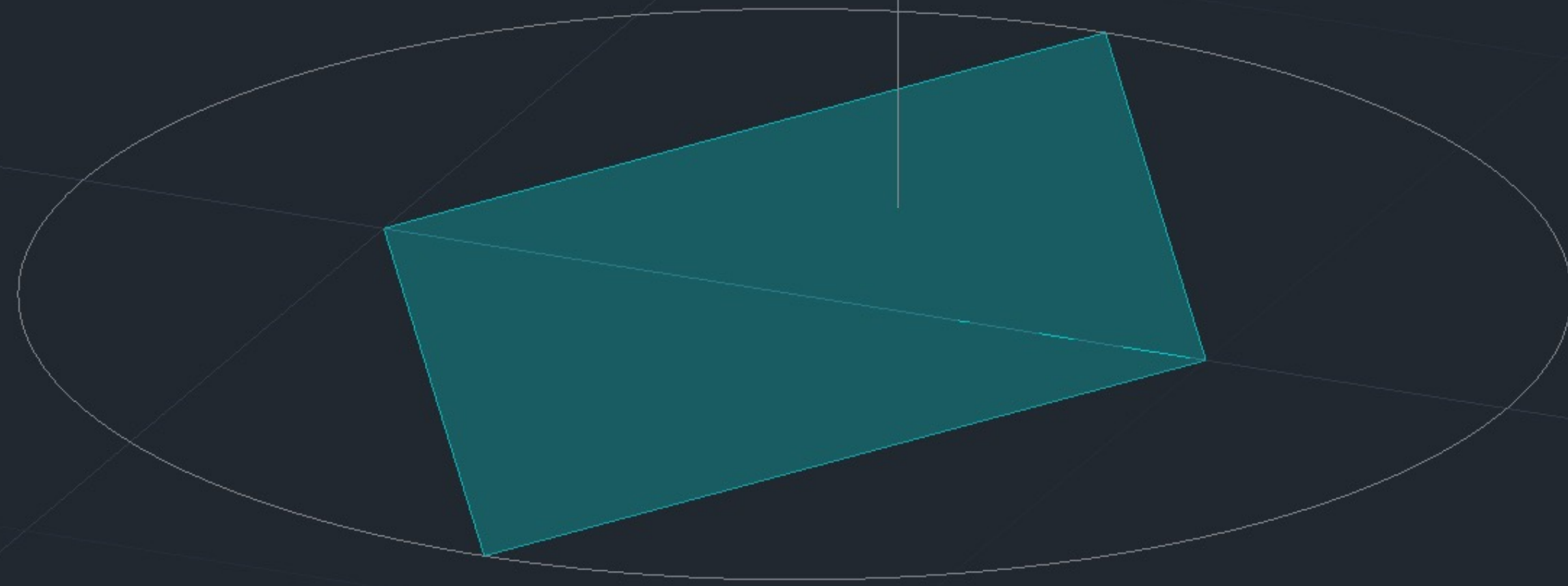

Exerc. 1.2 – Formas Tridimensionais

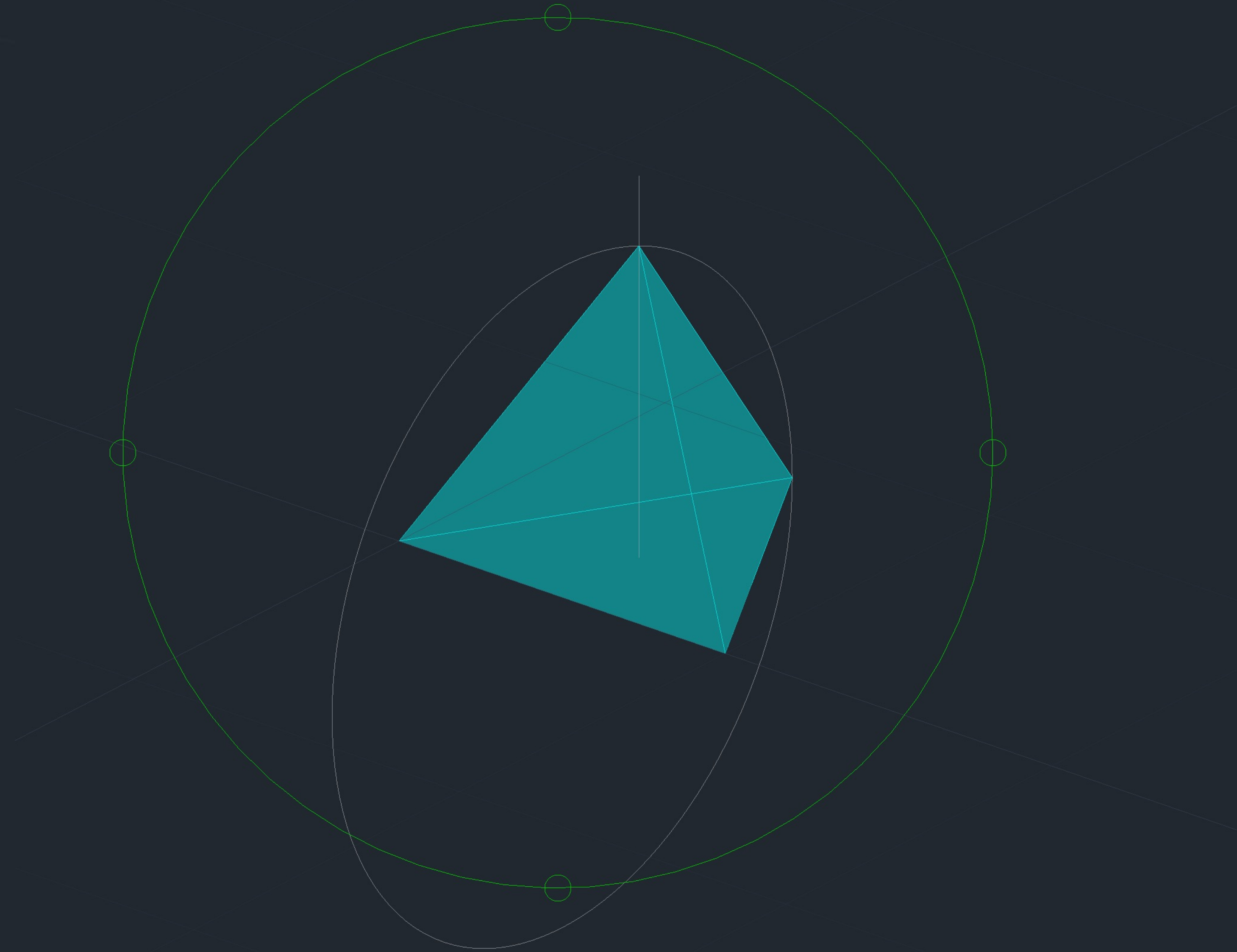

Exerc. 1.2 – Formas Tridimensionais

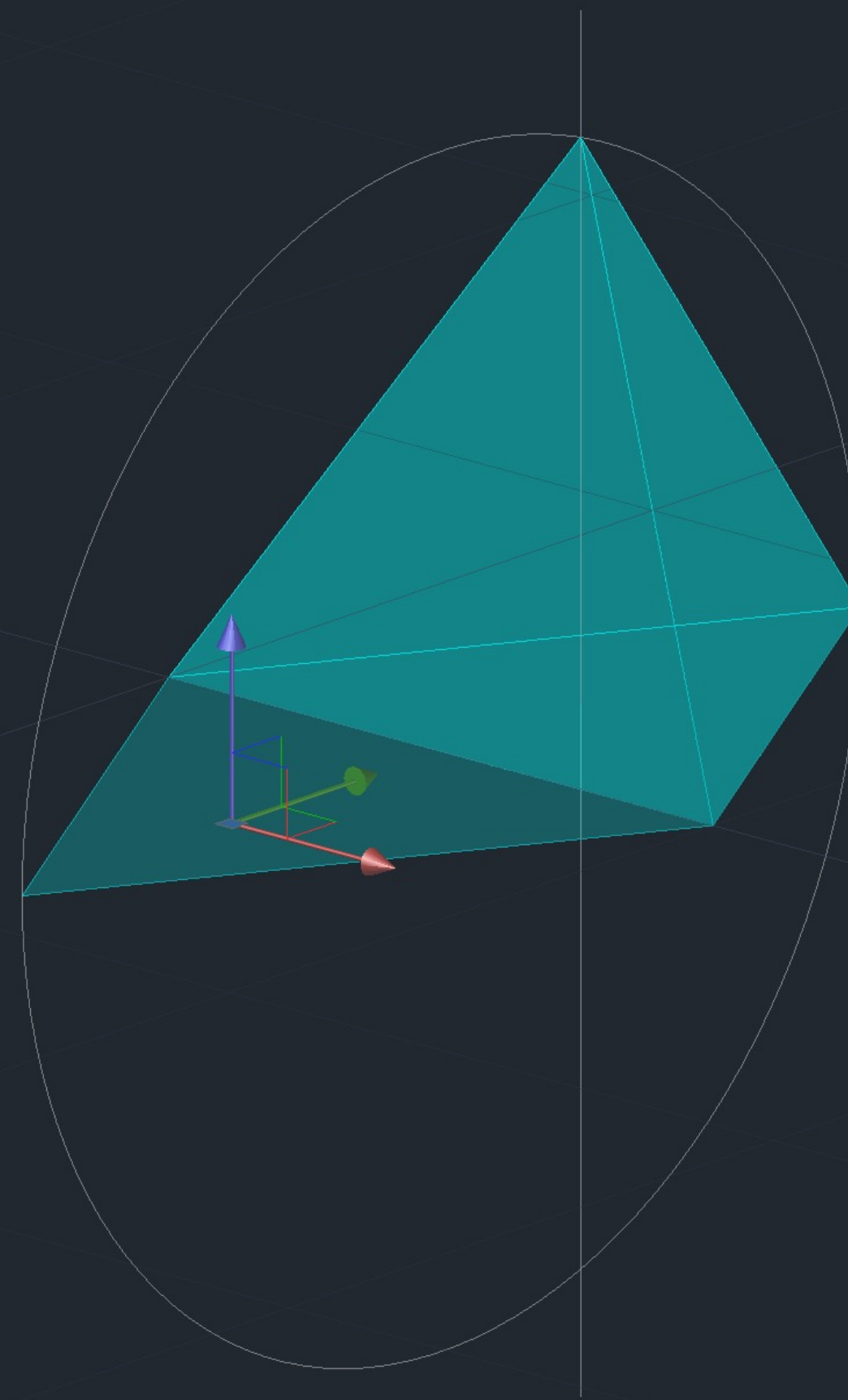

Exerc. 1.2 – Formas Tridimensionais

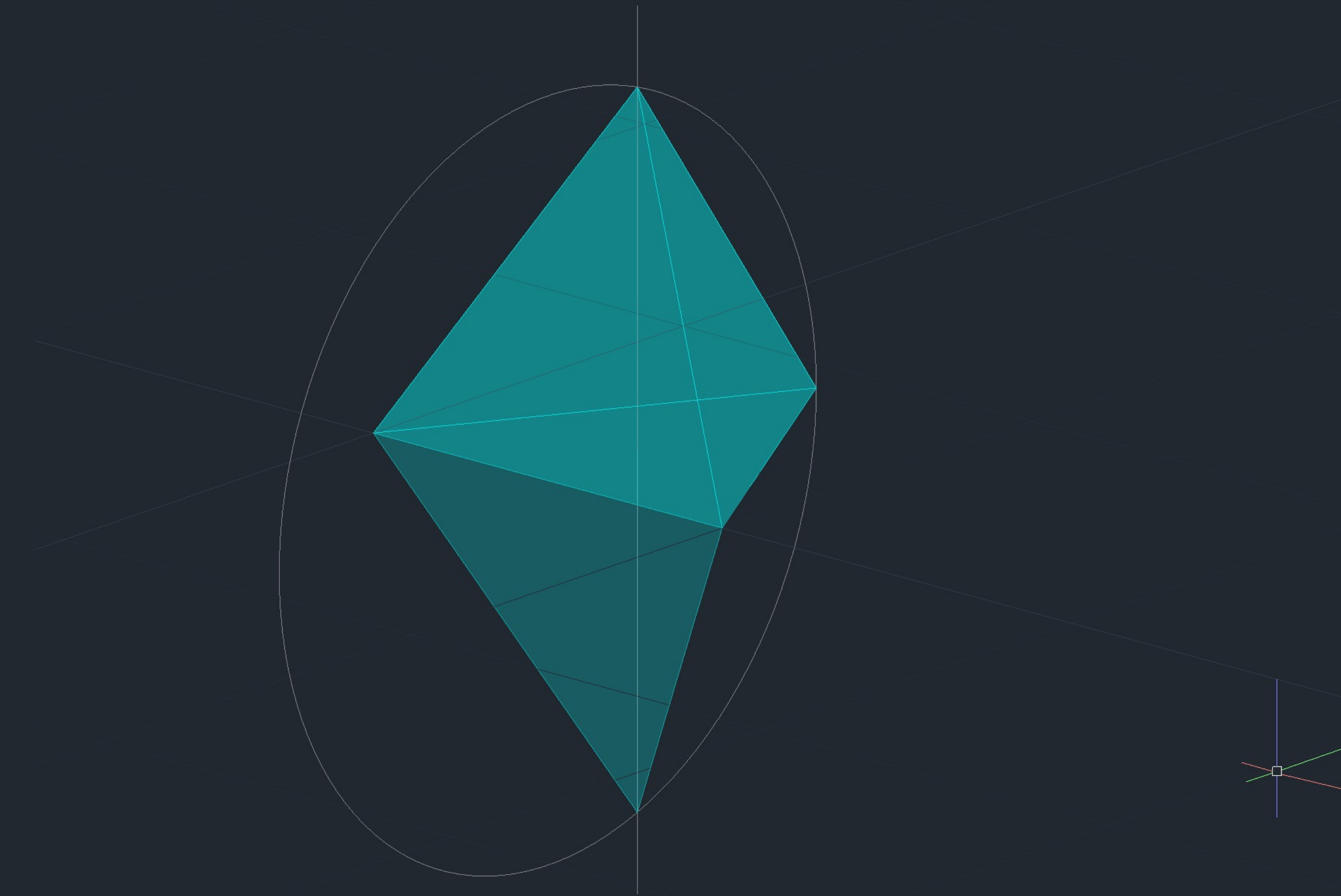

Exerc. 1.2 – Formas Tridimensionais



HEXAEDRO

Exerc. 1.2 – Formas Tridimensionais

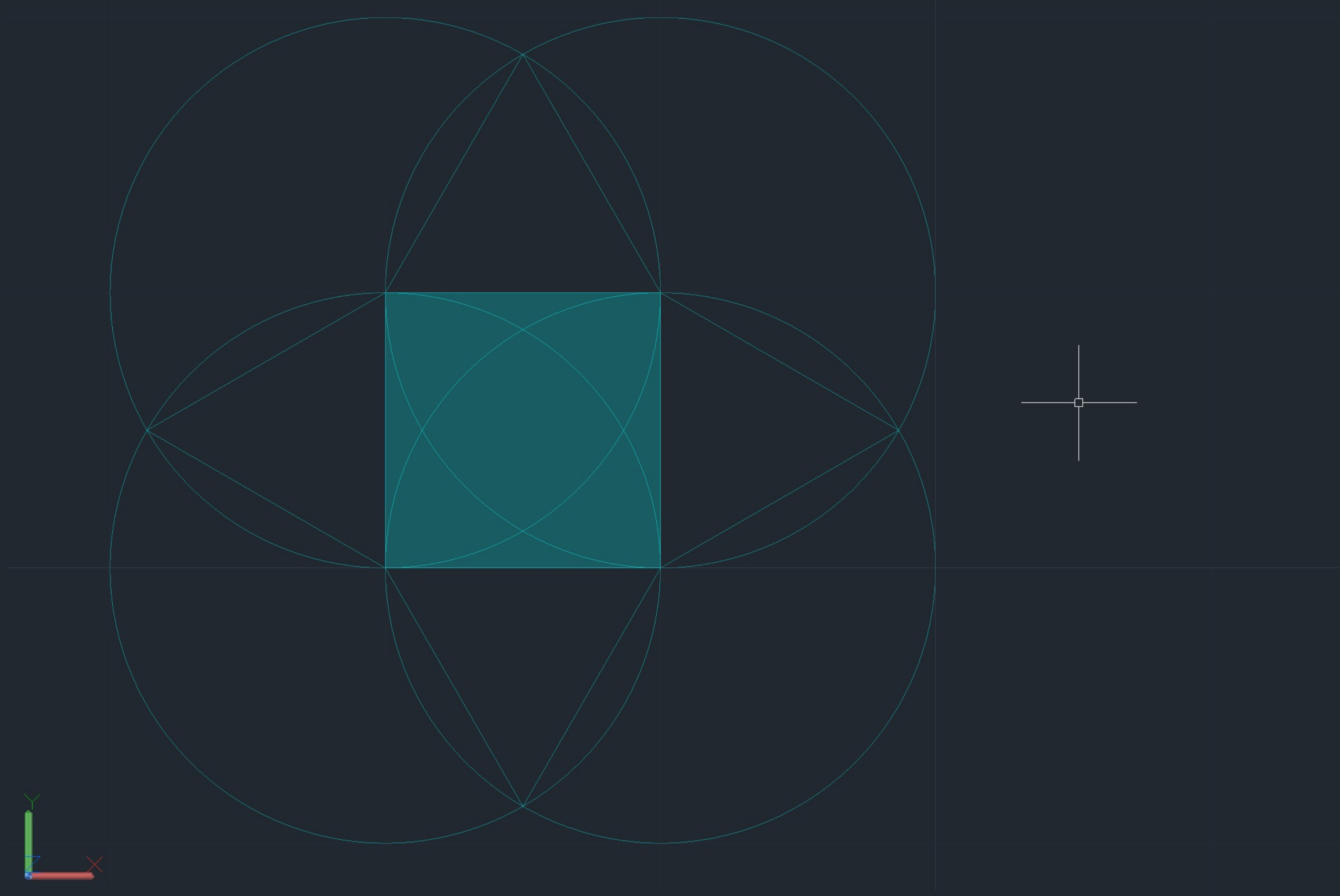

Exerc. 1.2 – Formas Tridimensionais

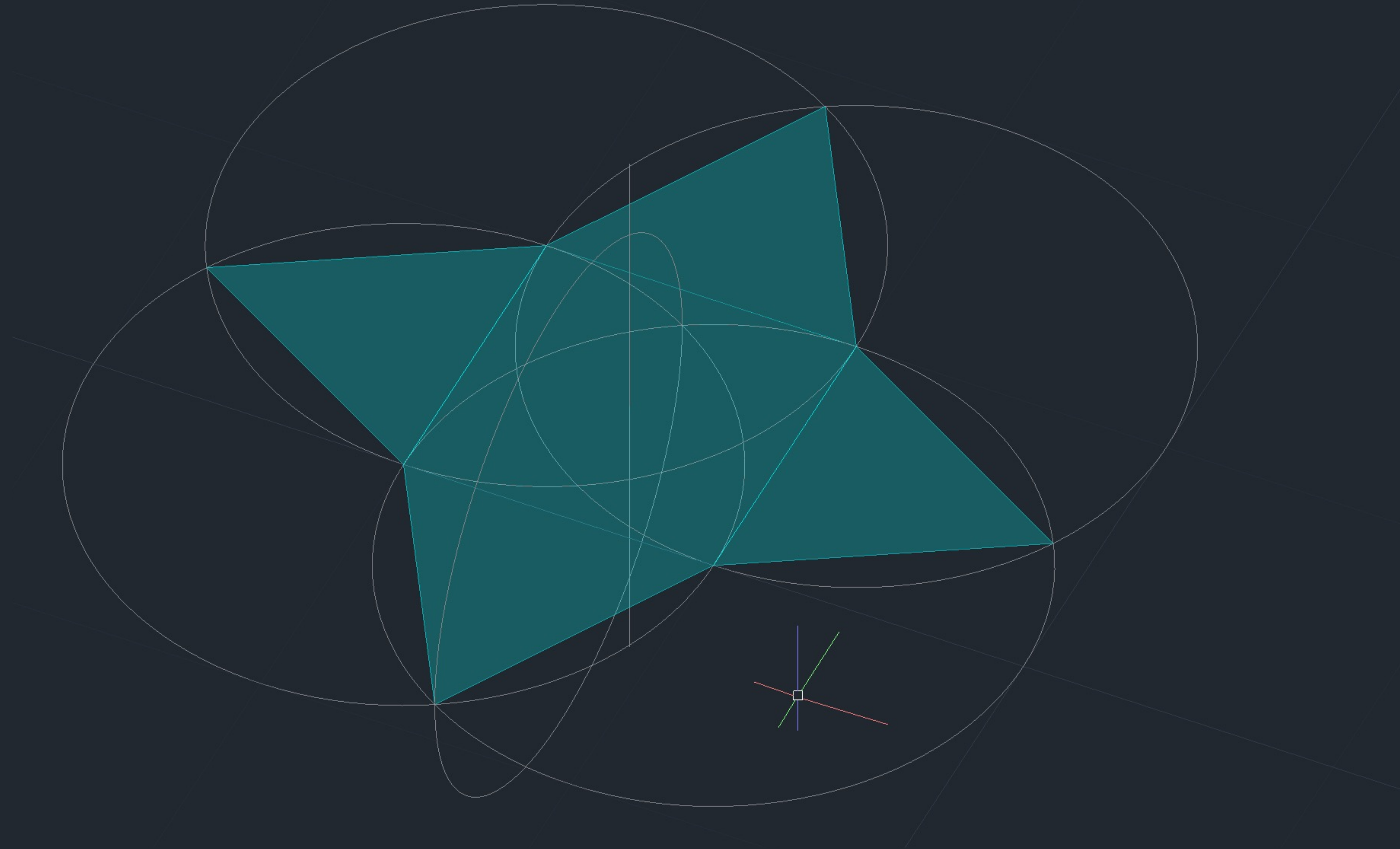

Exerc. 1.2 – Formas Tridimensionais

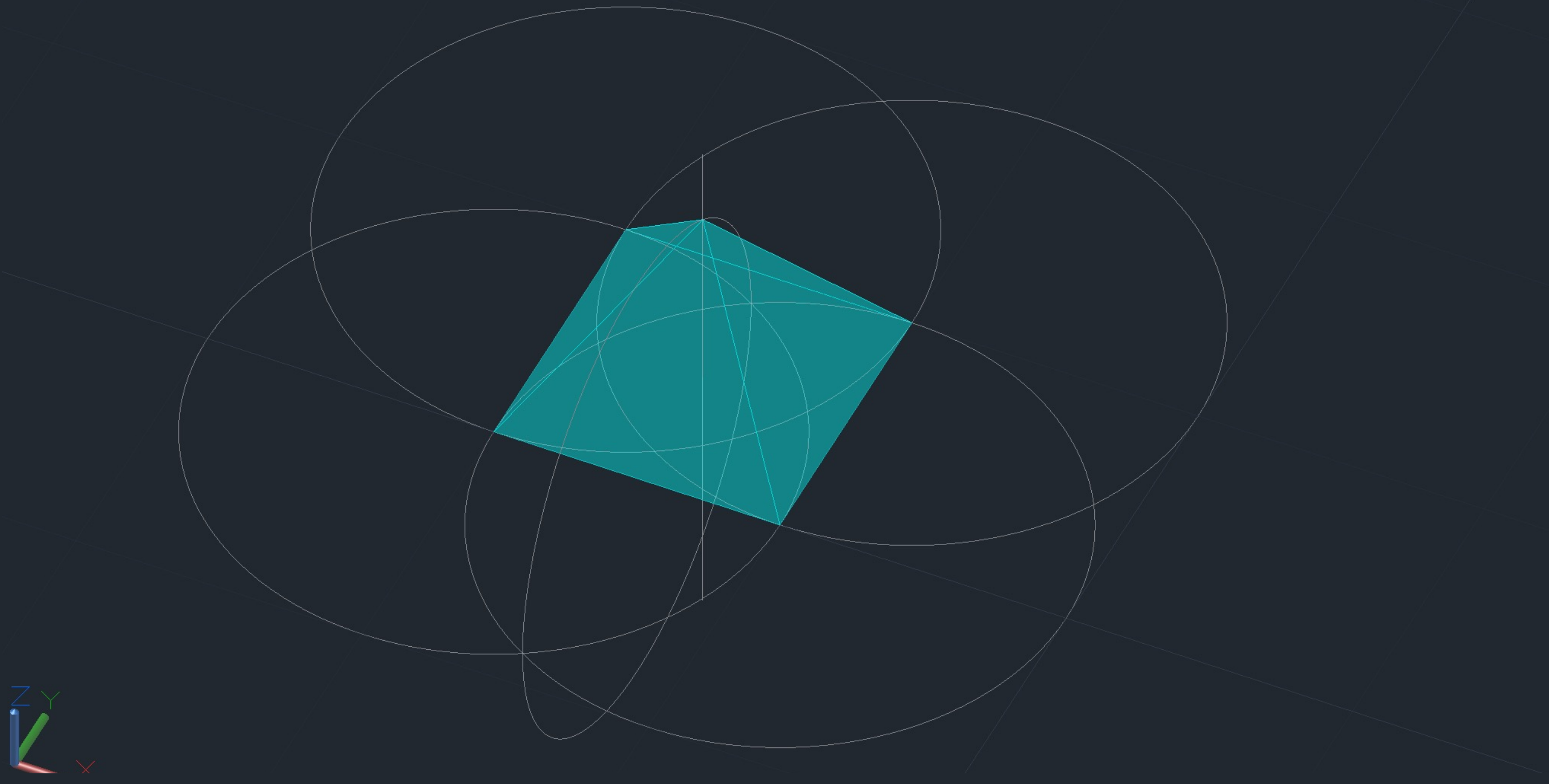

Exerc. 1.2 – Formas Tridimensionais



OCTAEDRO

Exerc. 1.2 – Formas Tridimensionais

DODECAEDRO

Exerc. 1.2 – Formas Tridimensionais

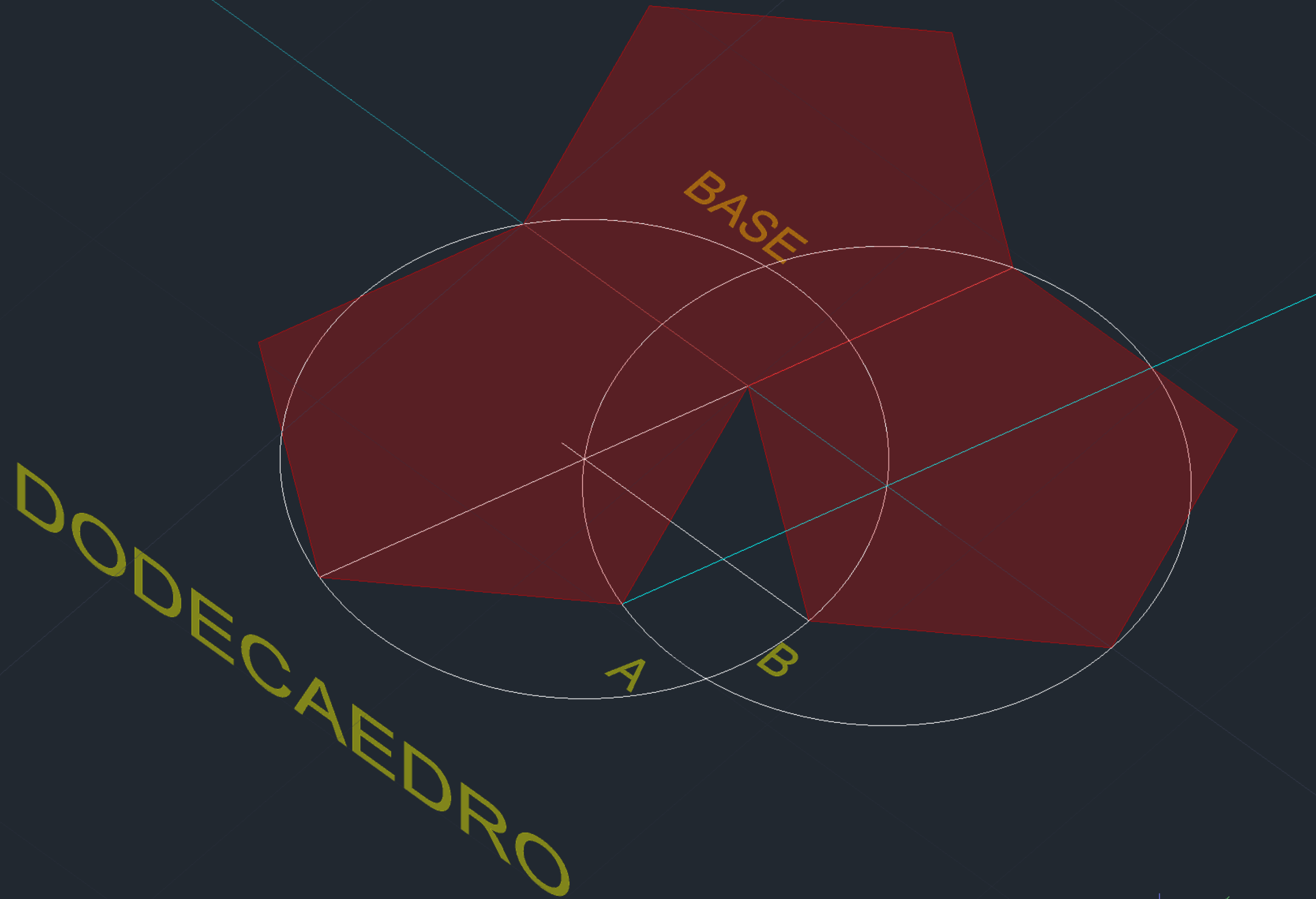

Exerc. 1.2 – Formas Tridimensionais

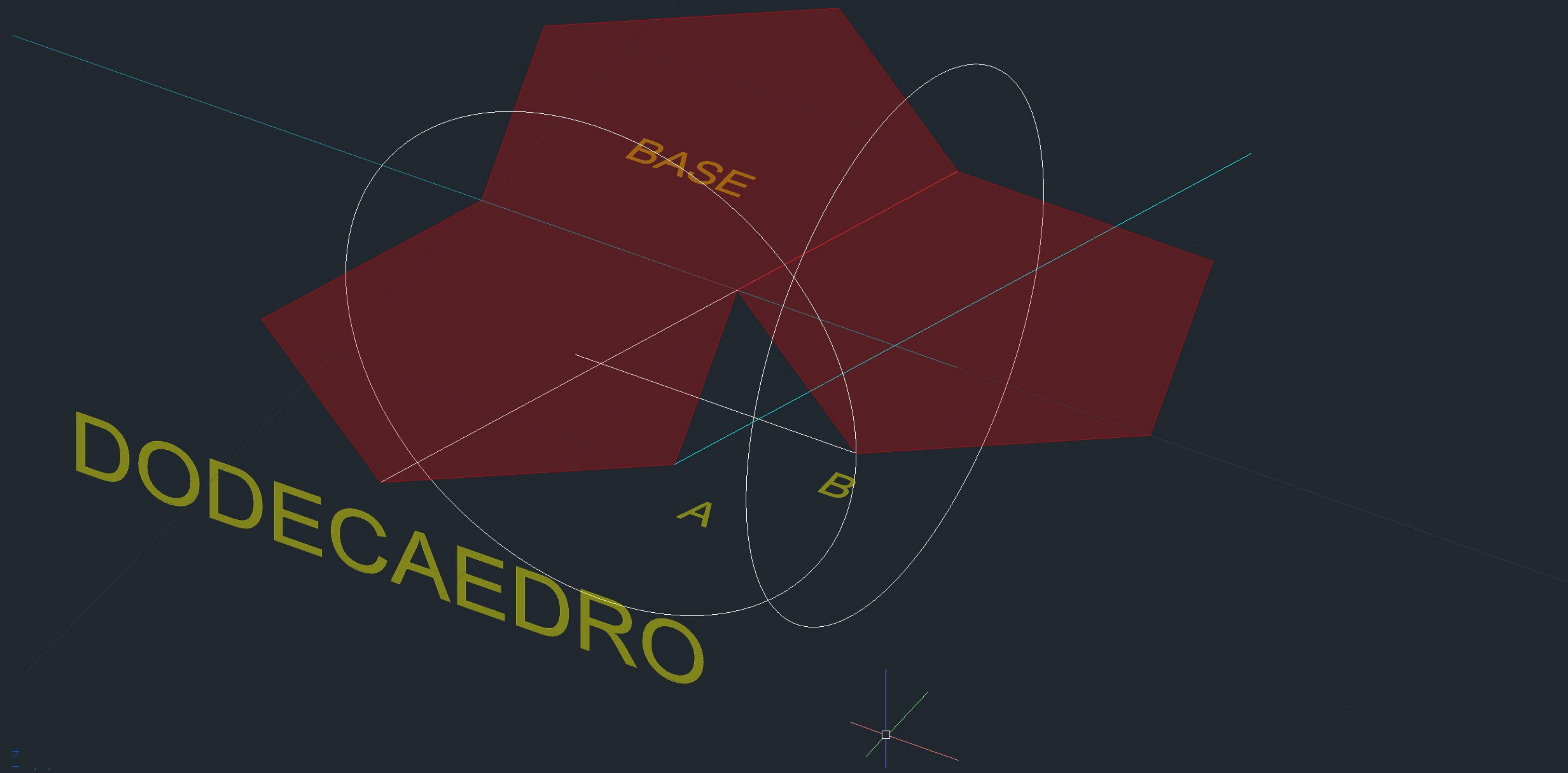

Exerc. 1.2 – Formas Tridimensionais

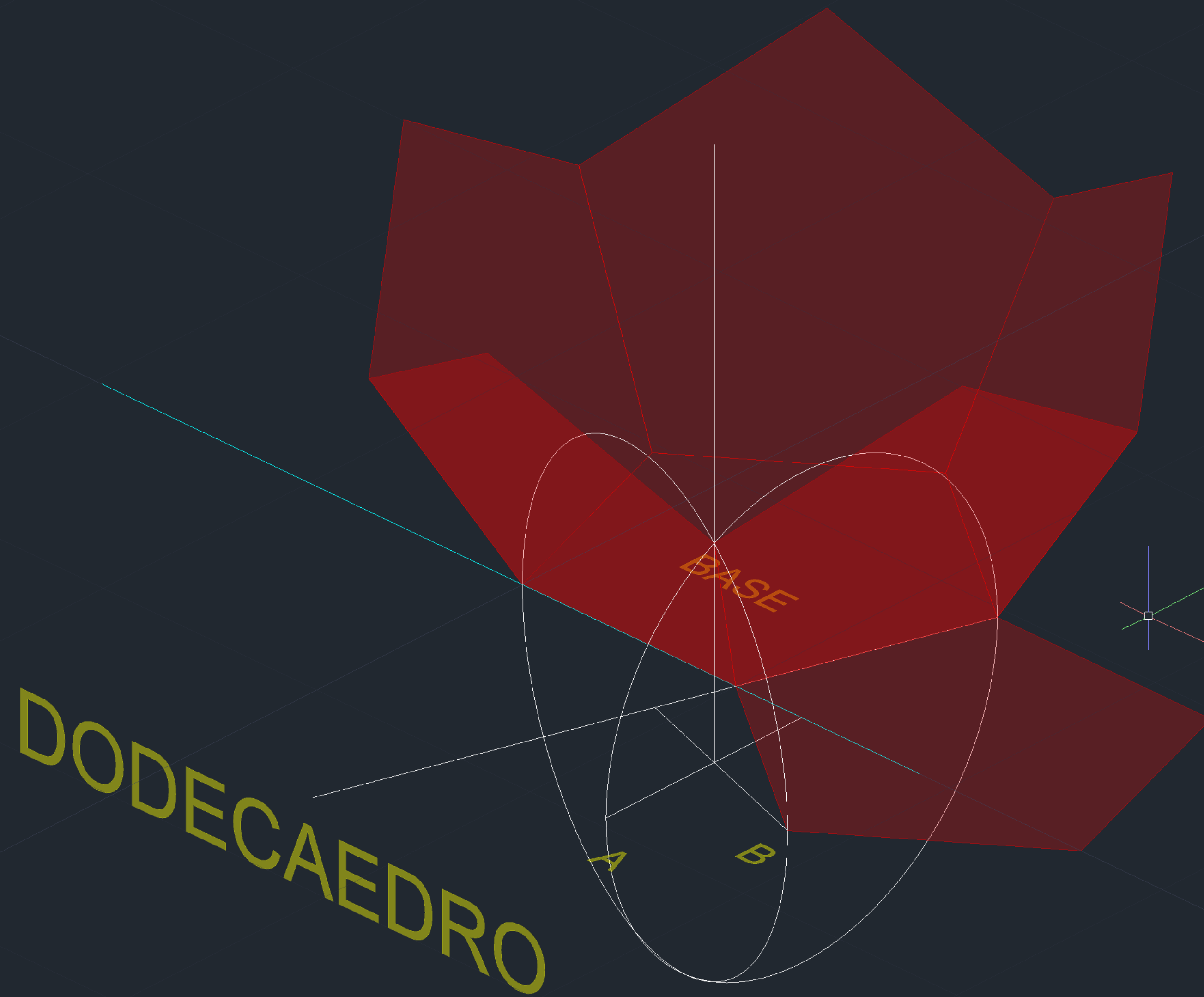

Exerc. 1.2 – Formas Tridimensionais

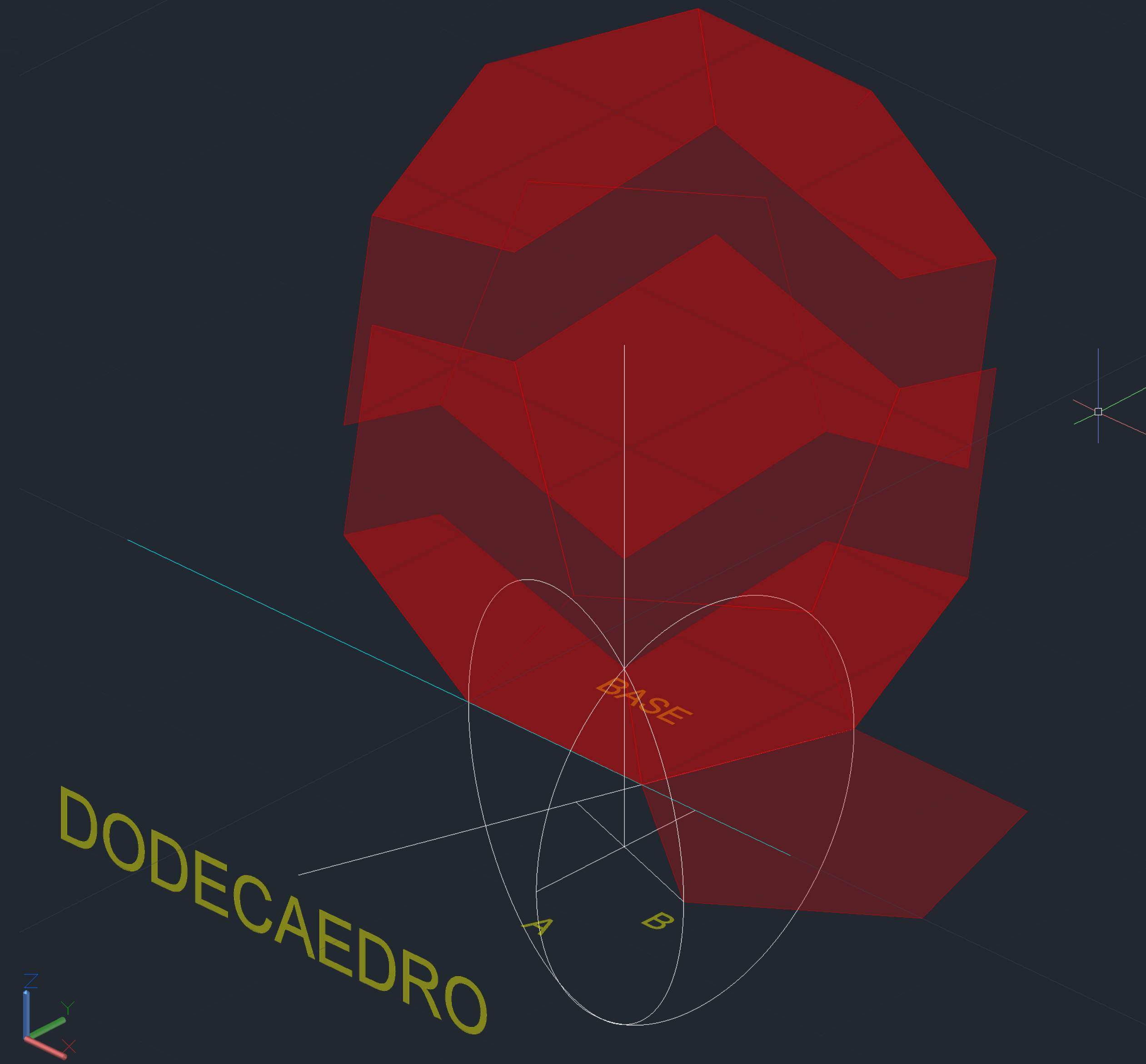

Exerc. 1.2 – Formas Tridimensionais

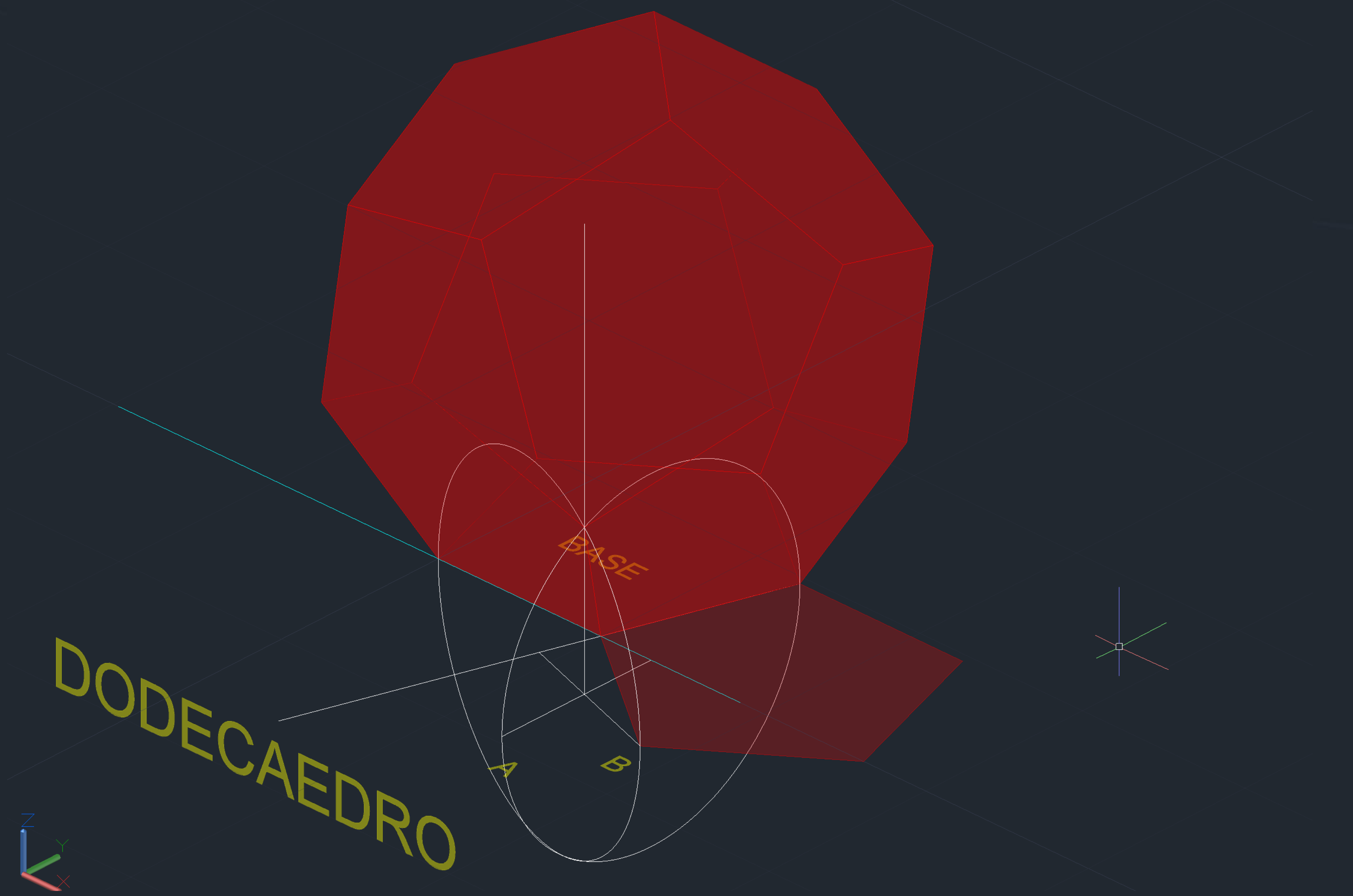

Exerc. 1.2 – Formas Tridimensionais



ICOSAEDRO

7

Exerc. 1.2 – Formas Tridimensionais

ICOSAEDRO

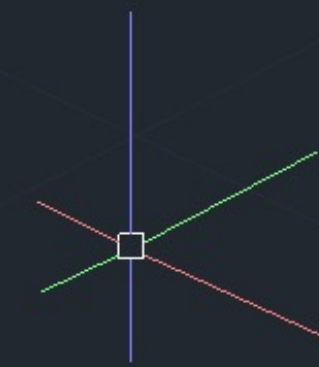
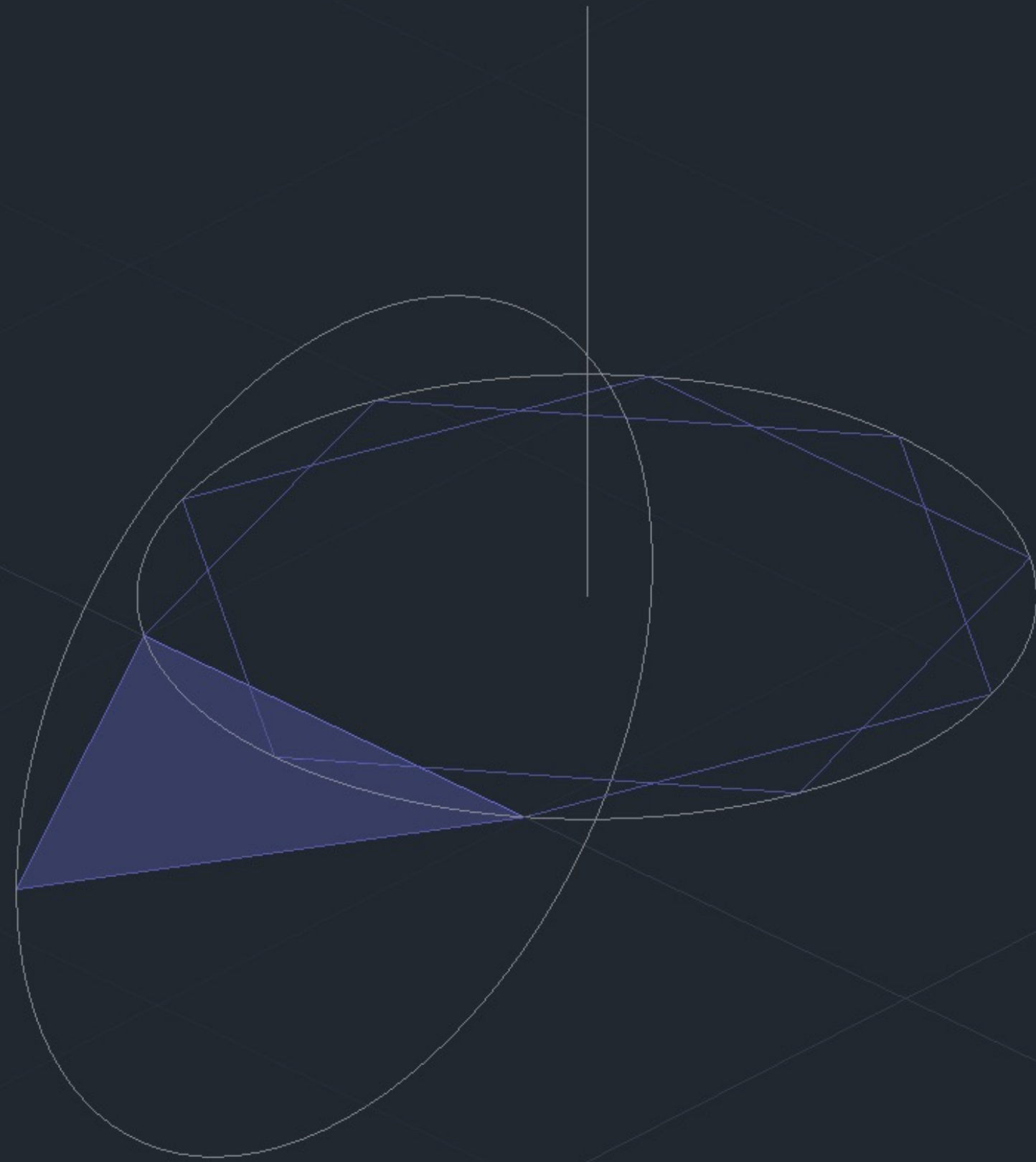

Exerc. 1.2 – Formas Tridimensionais

ICOSAEDRO

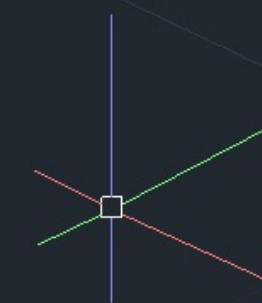

Exerc. 1.2 – Formas Tridimensionais

ICOSAEDRO

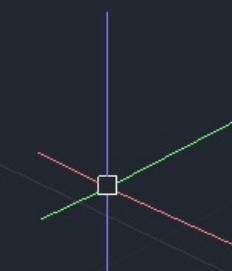

Exerc. 1.2 – Formas Tridimensionais

ICOSAEDRO

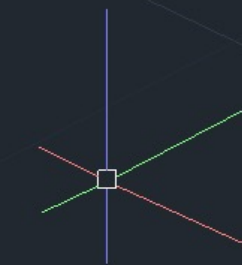
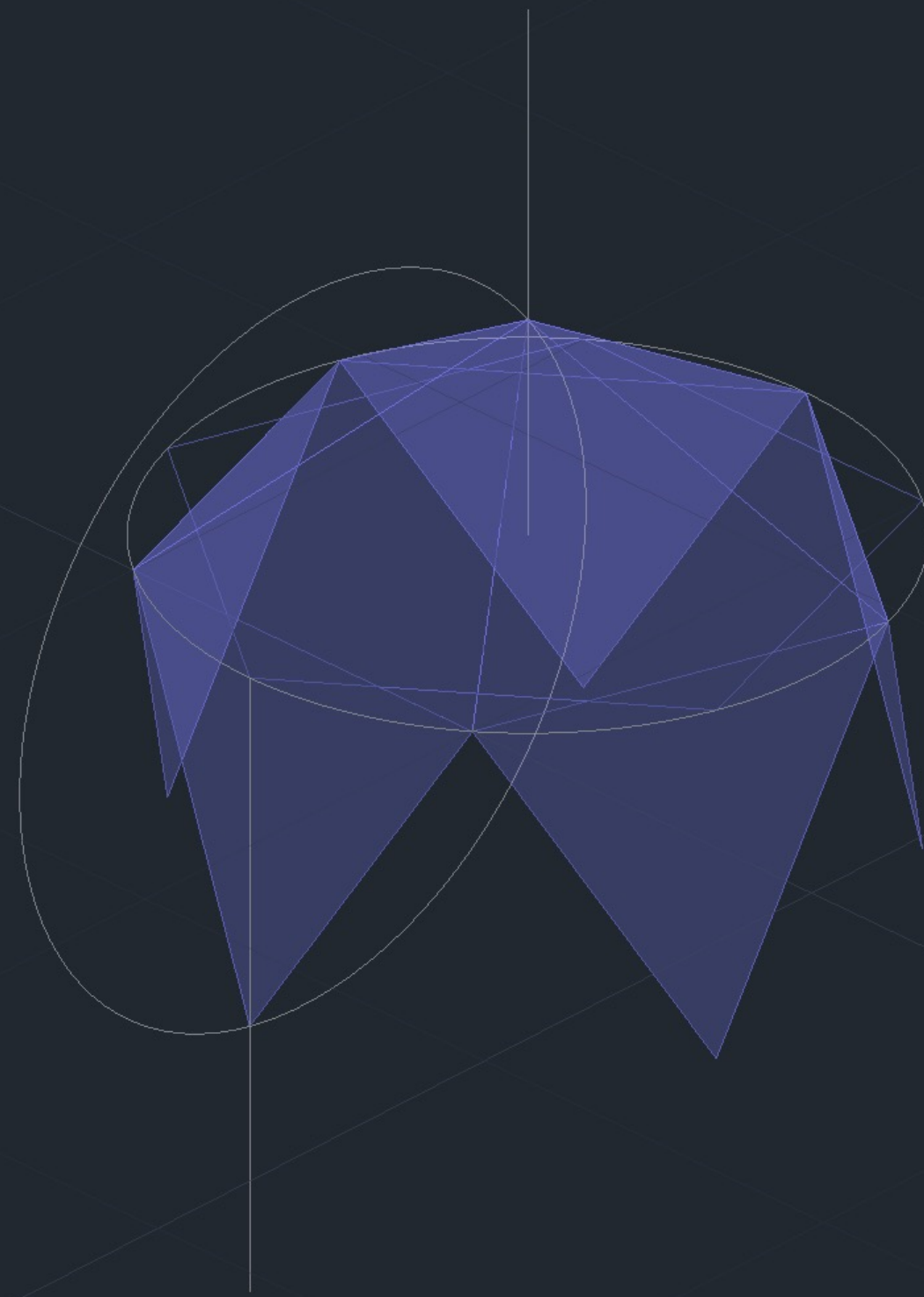

Exerc. 1.2 – Formas Tridimensionais

ICOSAEDRO

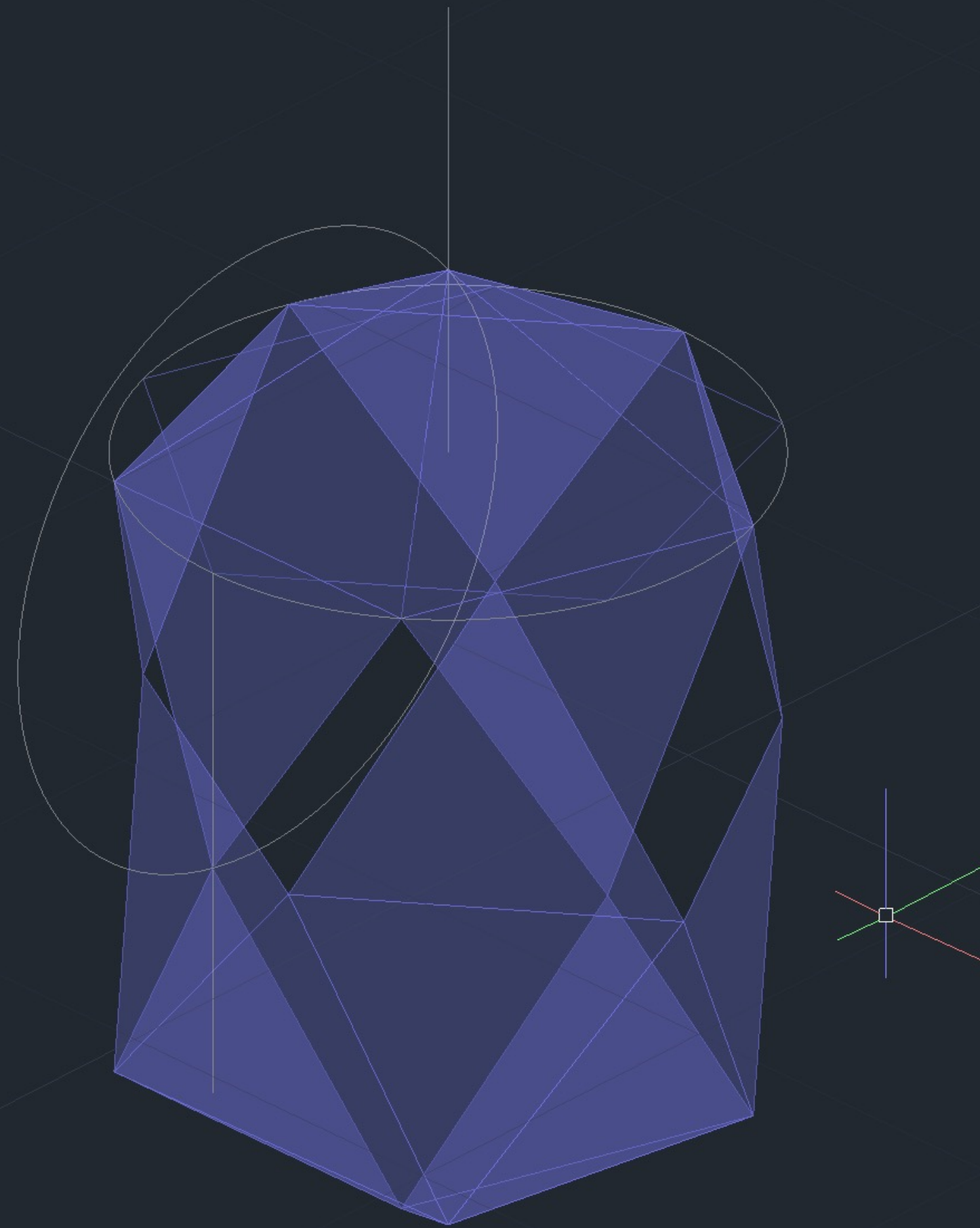

Exerc. 1.2 – Formas Tridimensionais

ICOSAEDRO

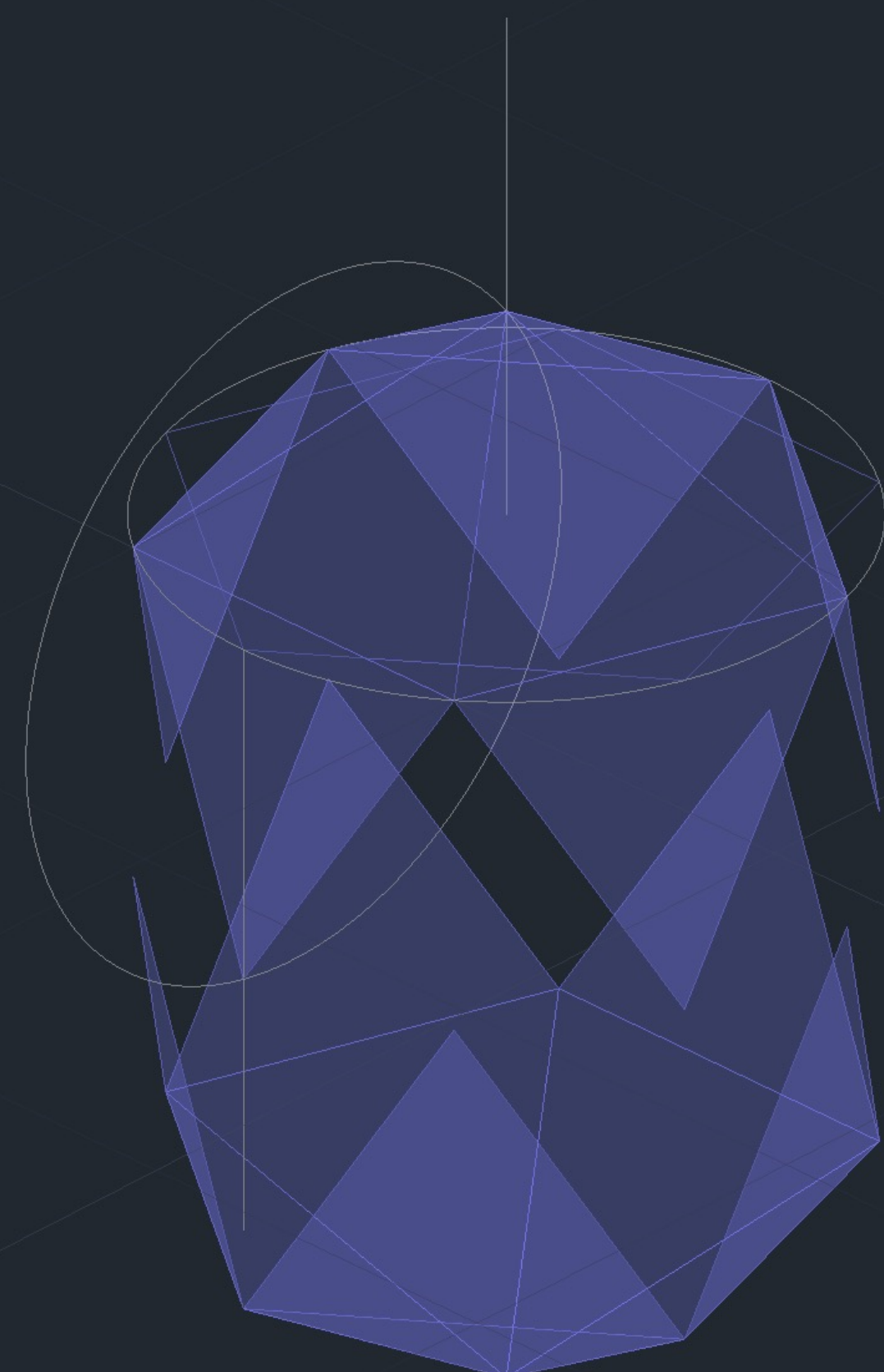

Exerc. 1.2 – Formas Tridimensionais

ICOSAEDRO

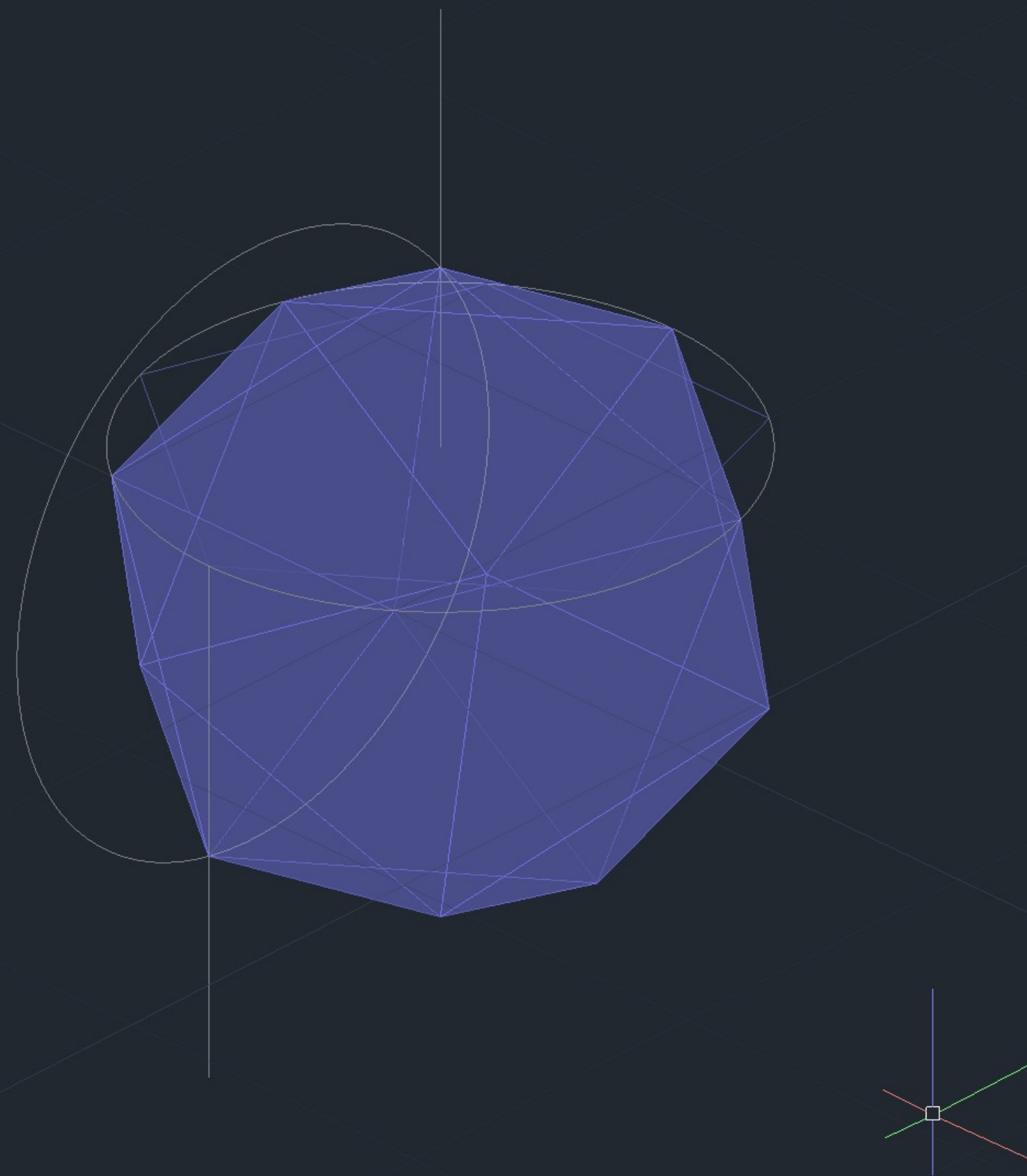

Exerc. 1.2 – Formas Tridimensionais

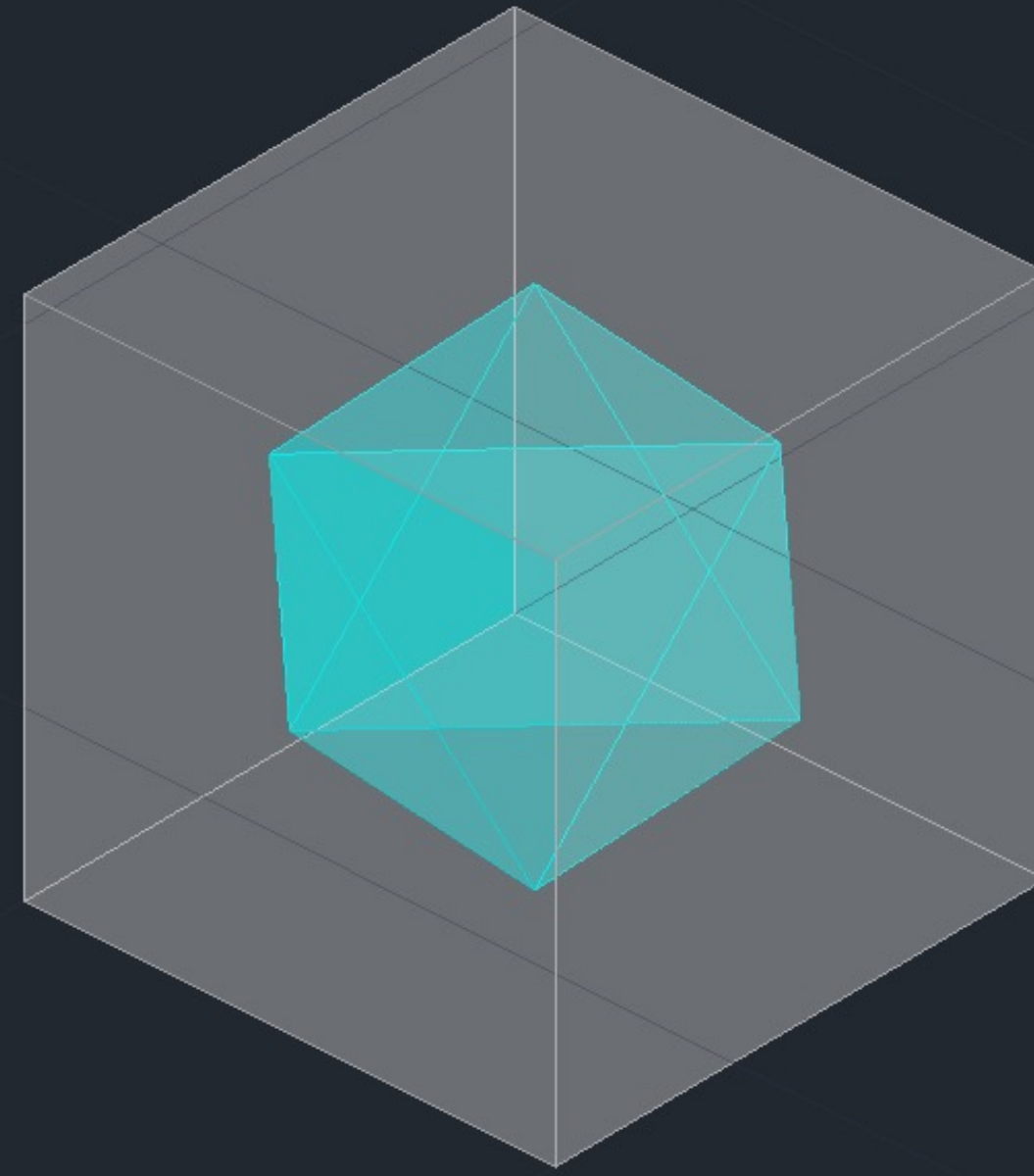

Exerc. 1.3 – Dualidades

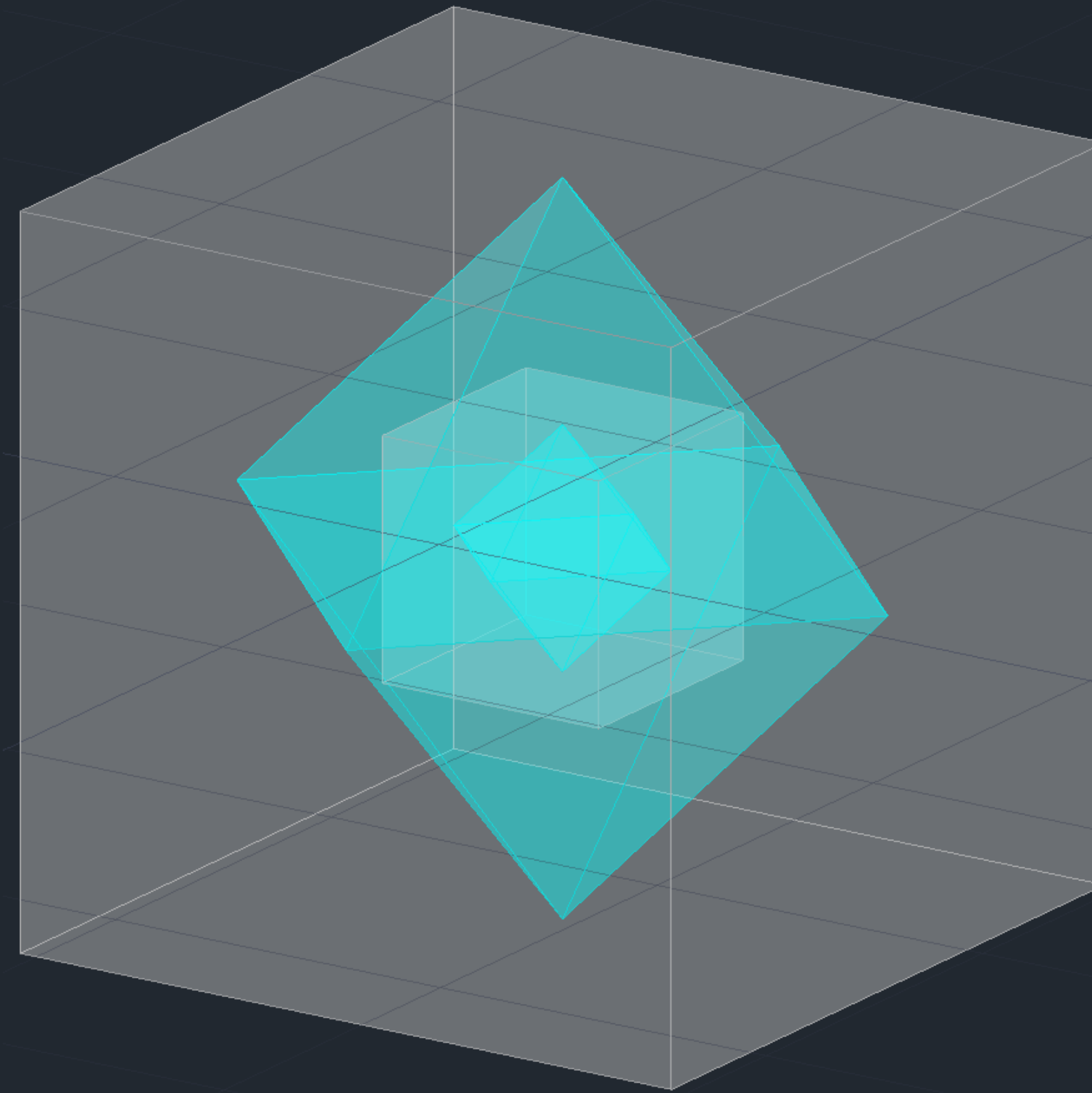

Exerc. 1.3 – Dualidades

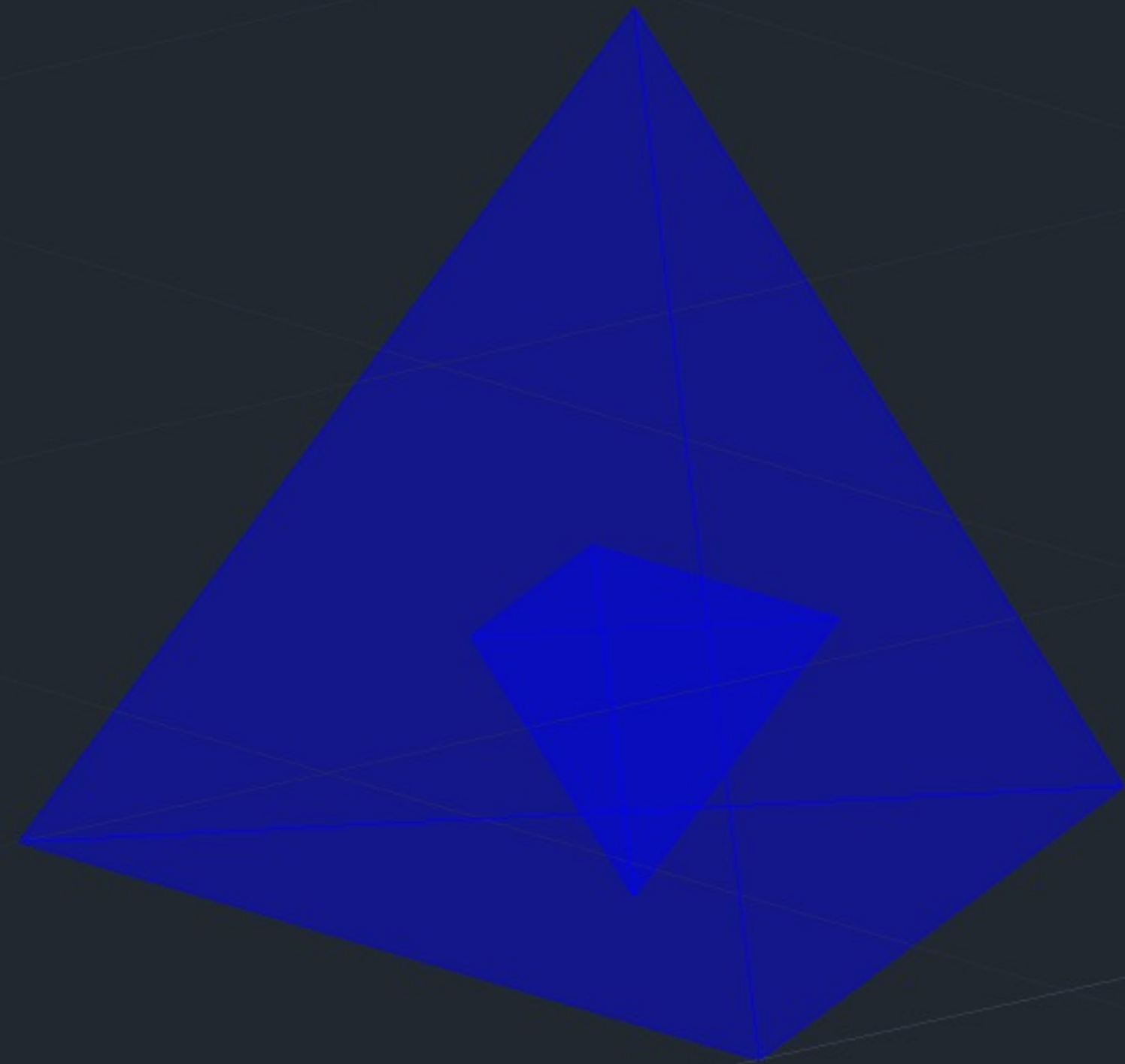

Exerc. 1.3 – Dualidades

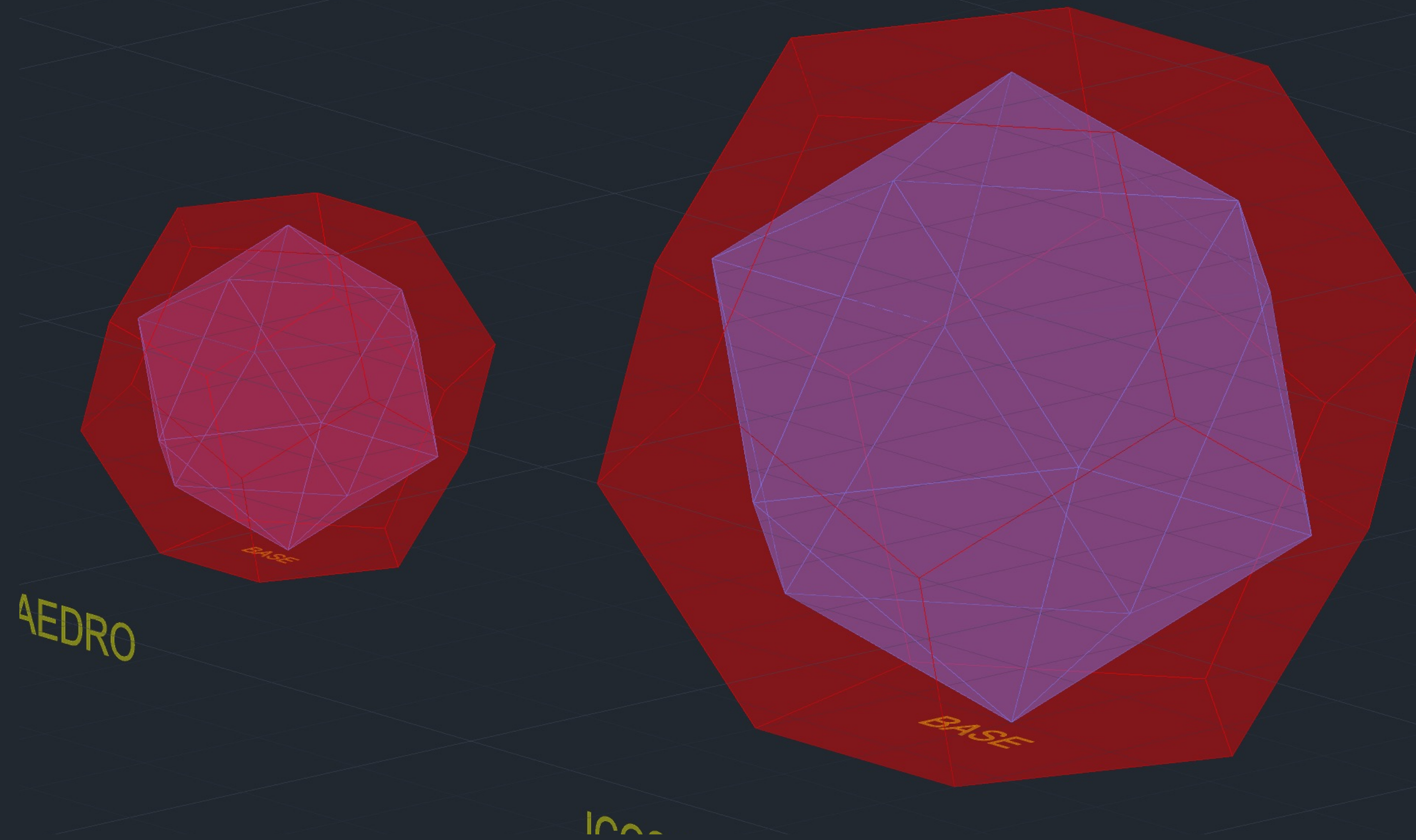

Exerc. 1.3 – Dualidades

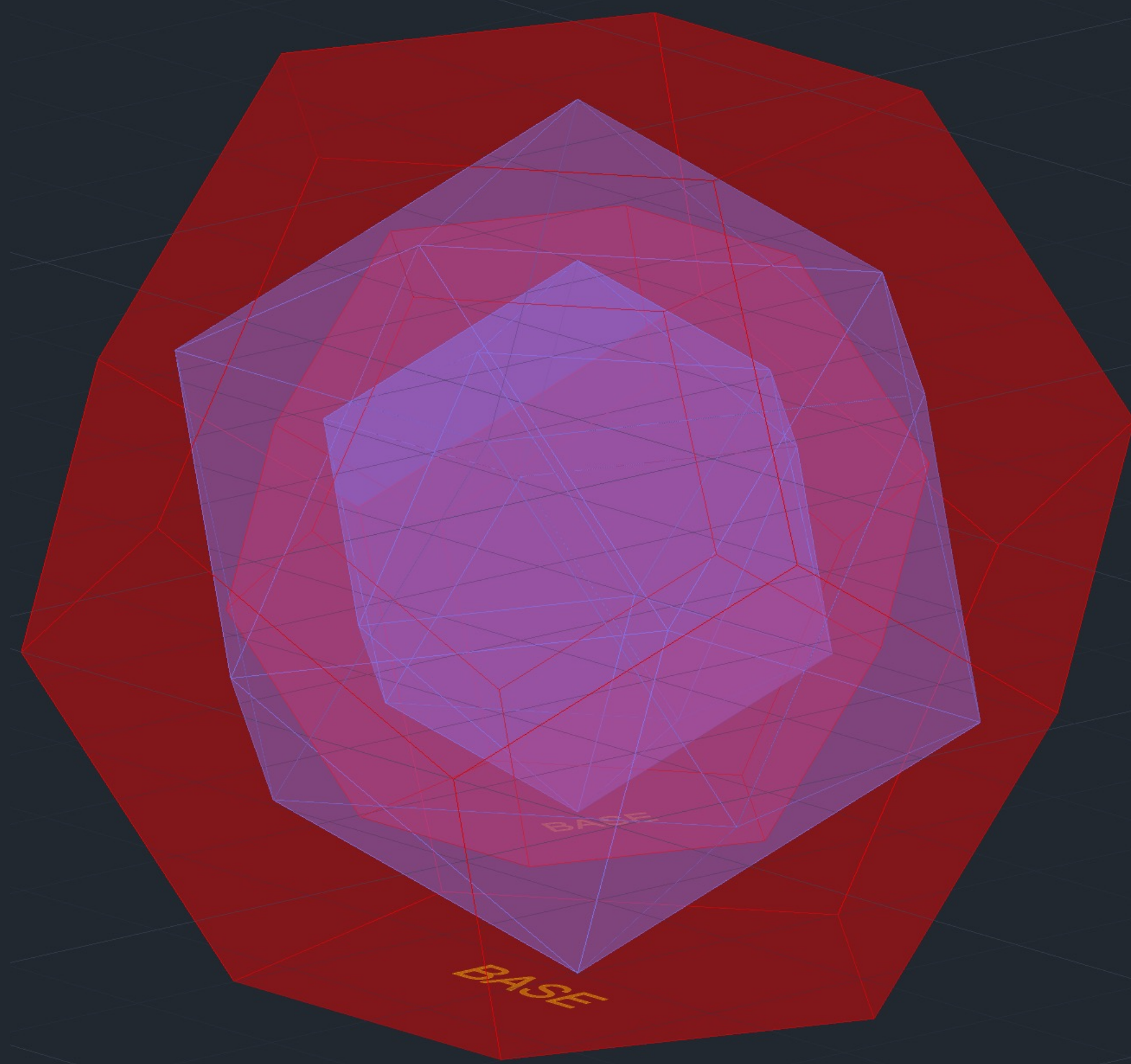

Exerc. 1.3 – Dualidades

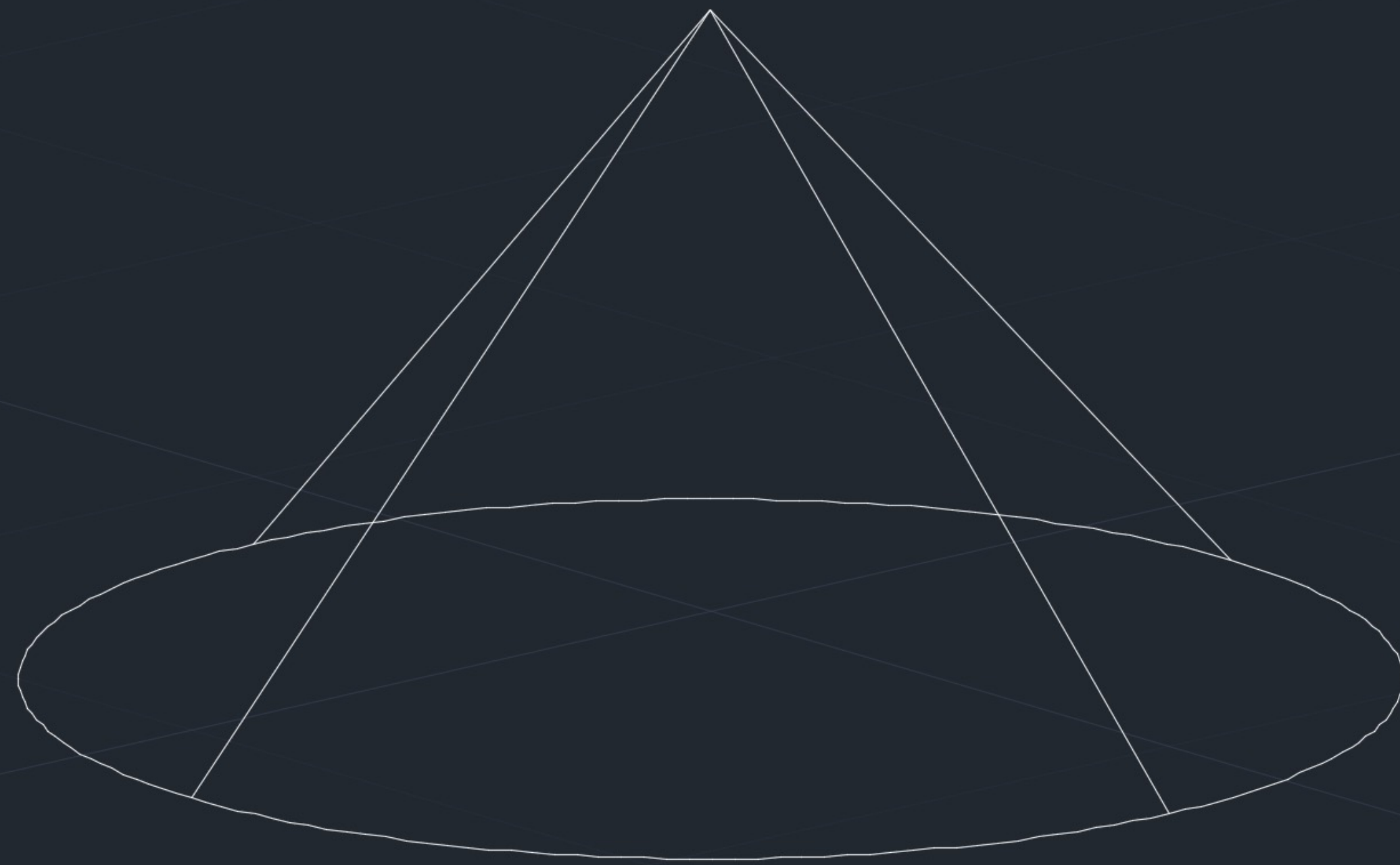

Exerc. 2.1 – Cone - Secções

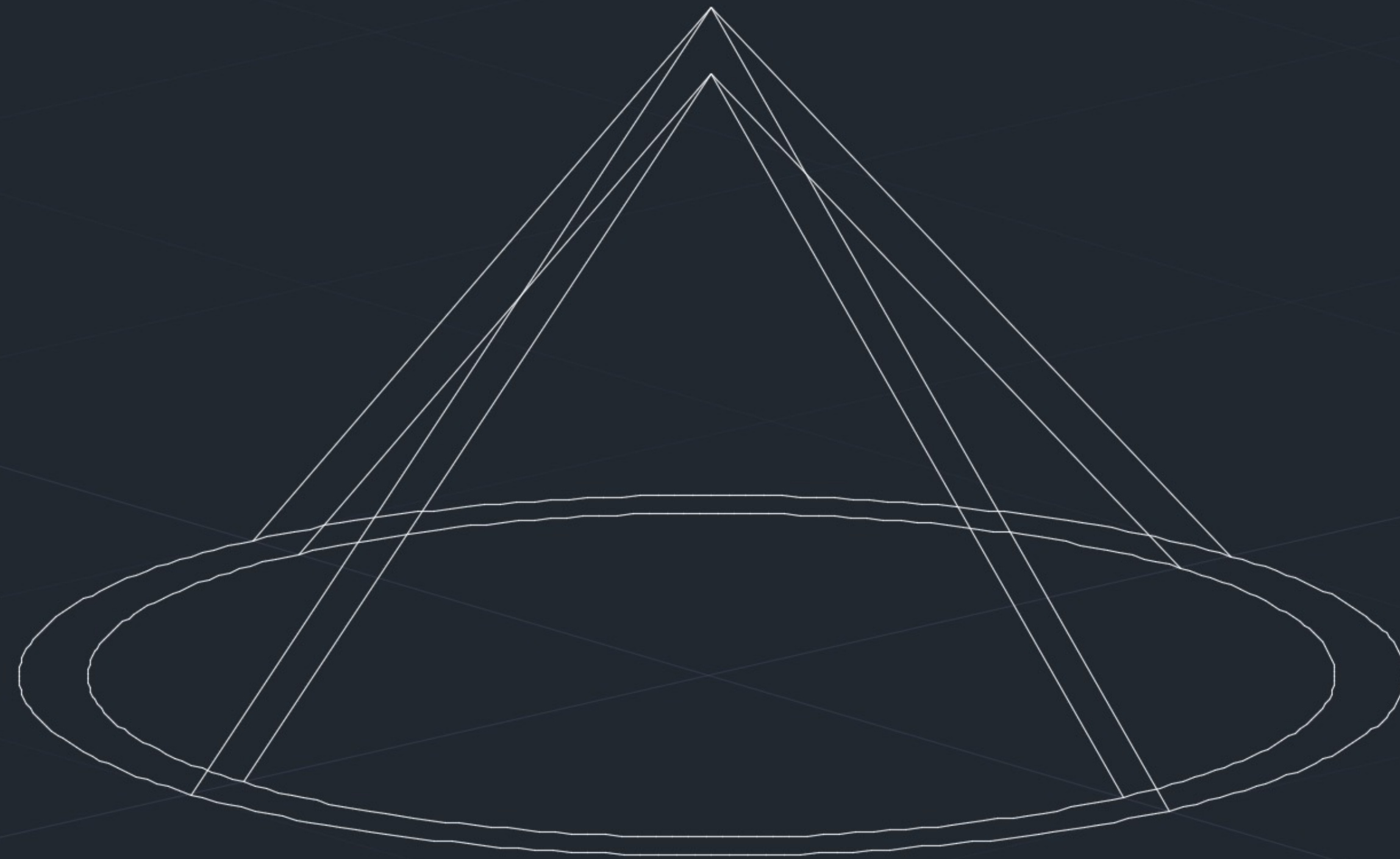

Exerc. 2.1 –Cone - Secções

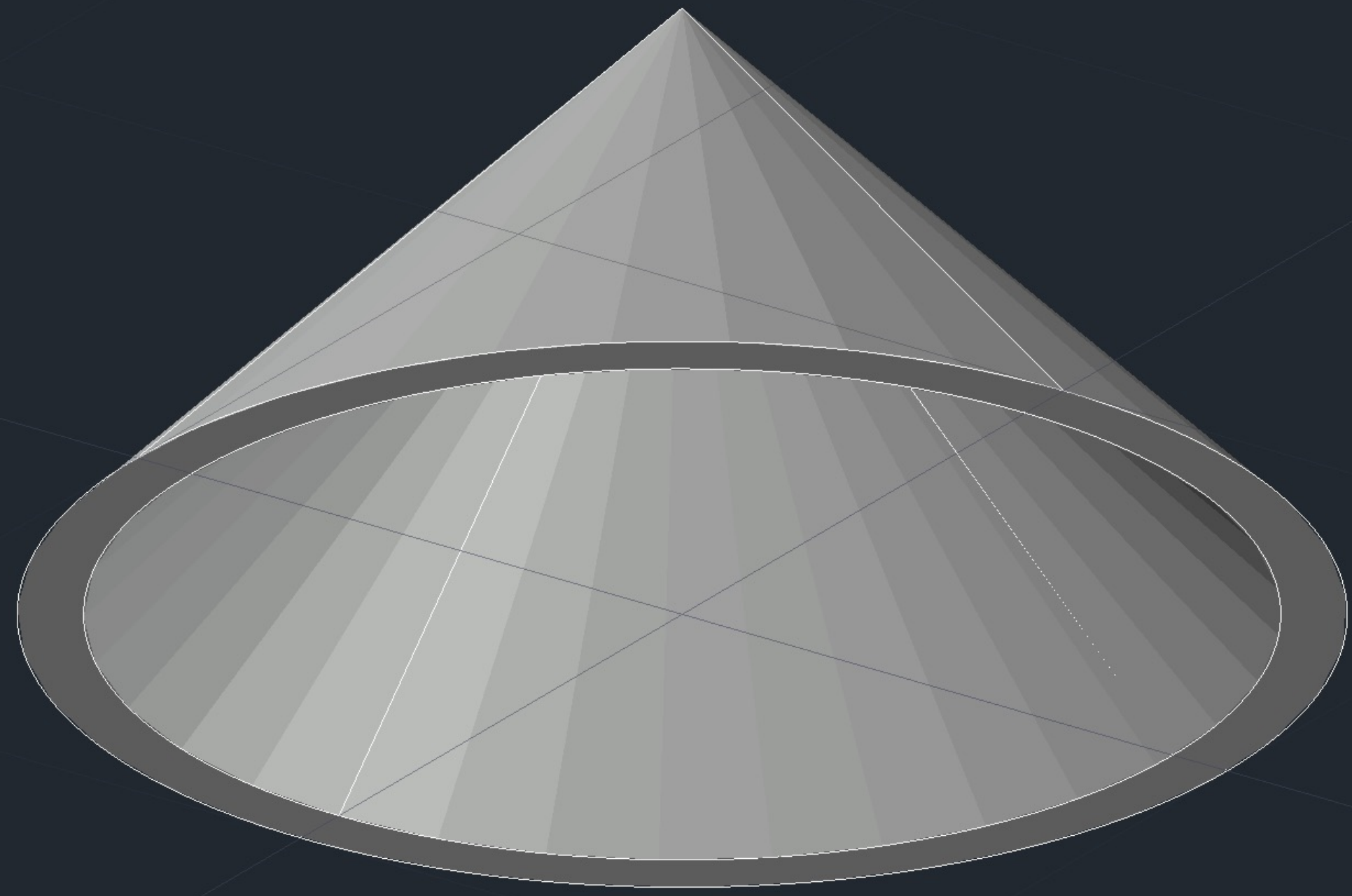

Exerc. 2.1 –Cone - Secções

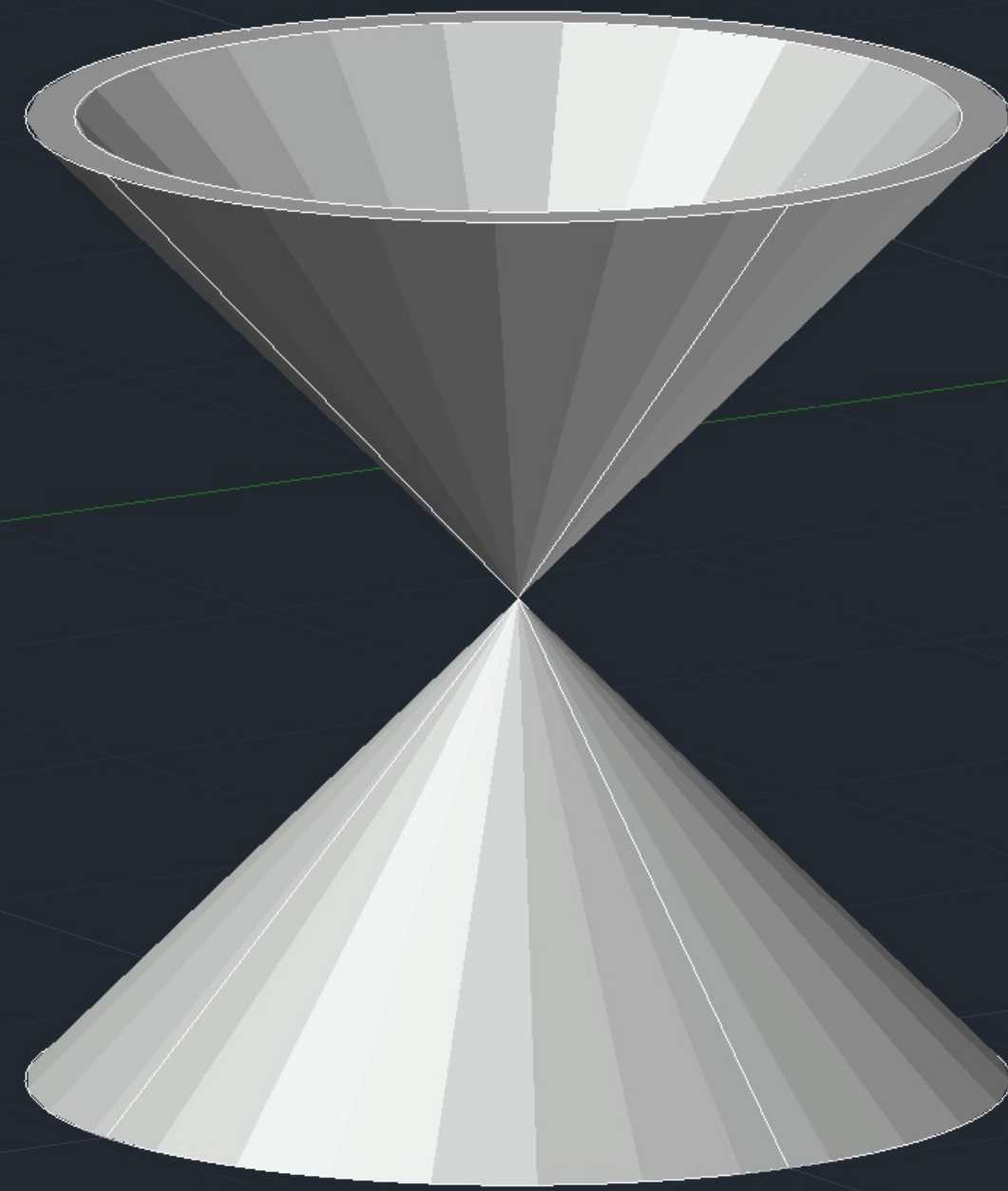

Exerc. 2.1 – Cone - Secções

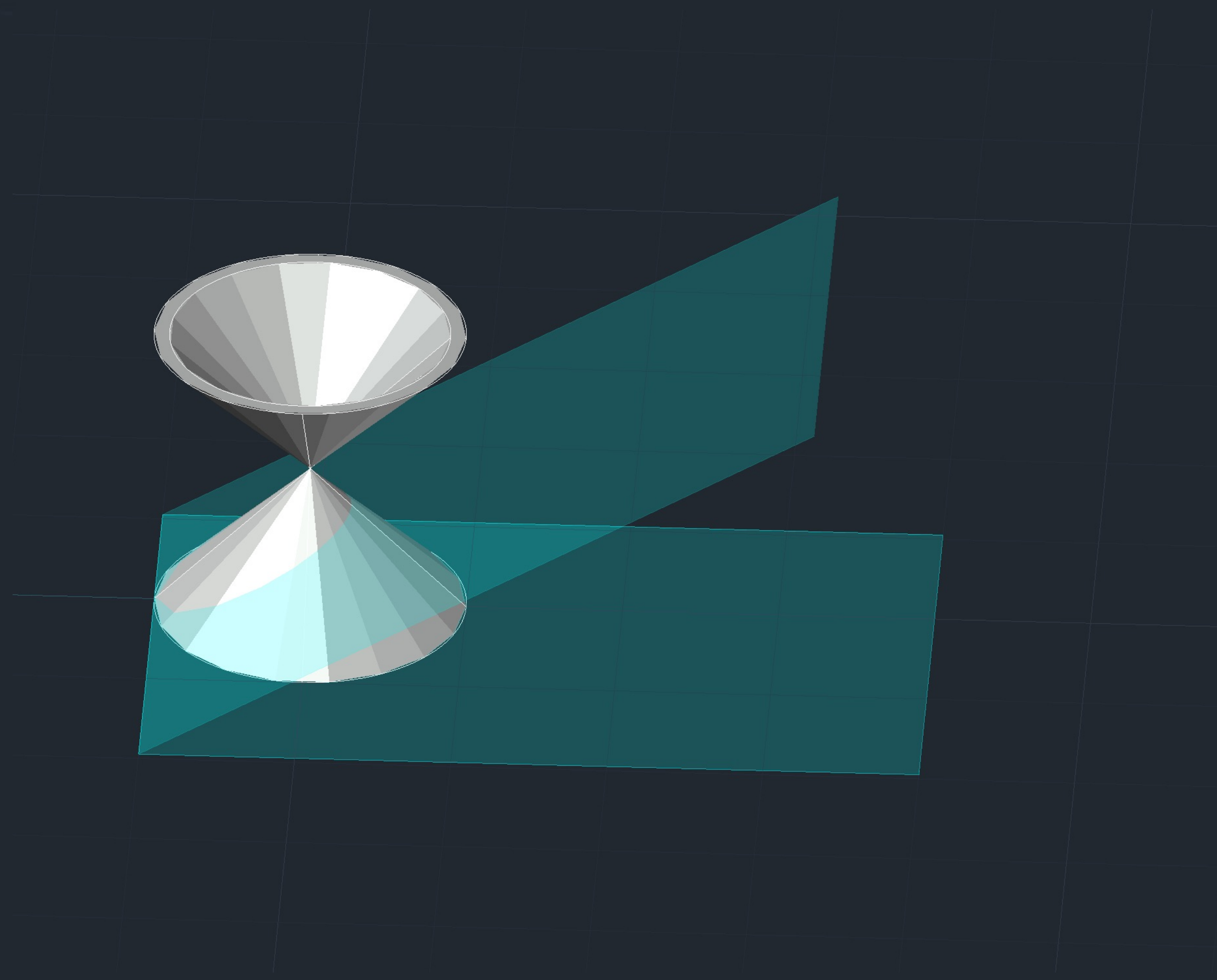

Exerc. 2.1 – Cone - Secções

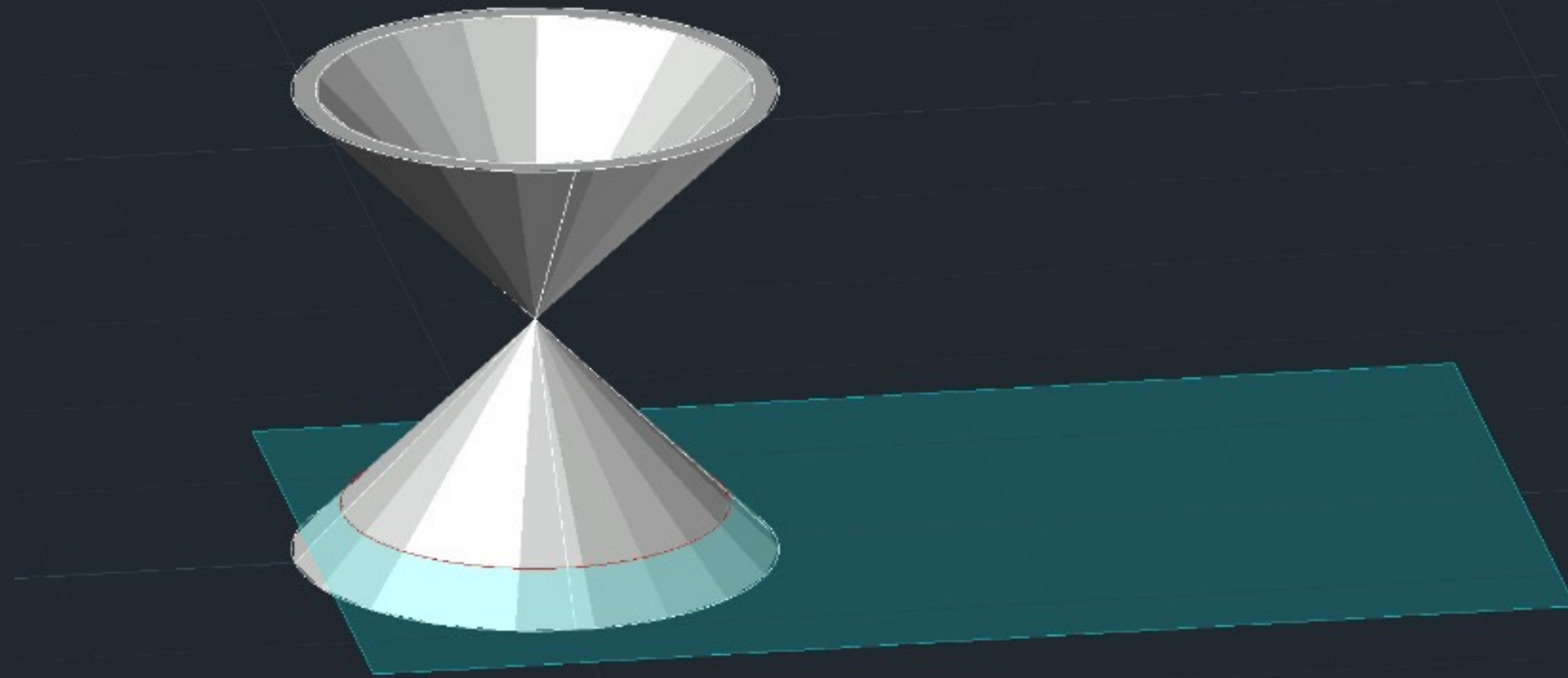

Exerc. 2.1 – Cone - Secções

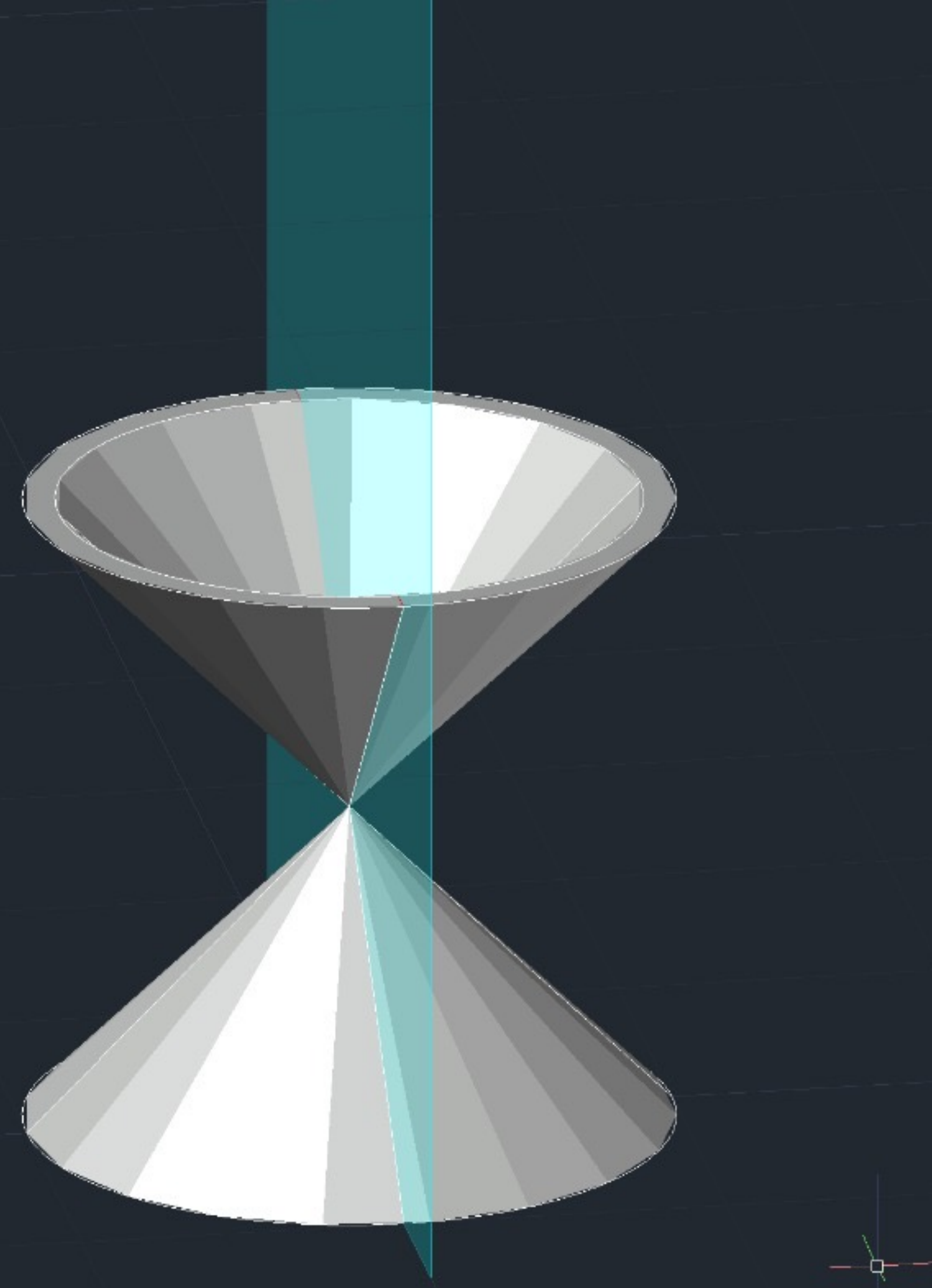

Exerc. 2.1 – Cone - Secções

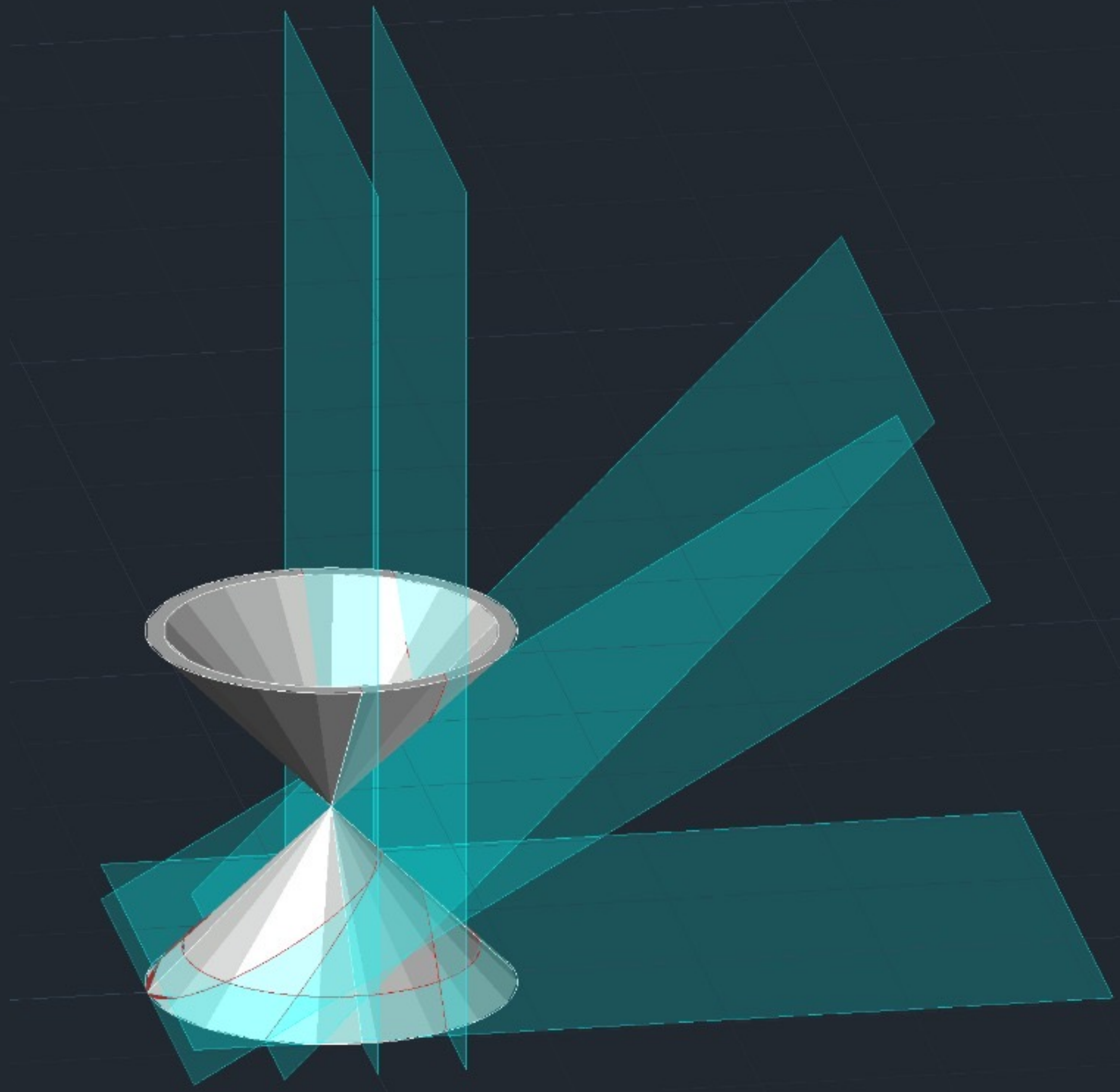

Exerc. 2.1 – Cone - Secções

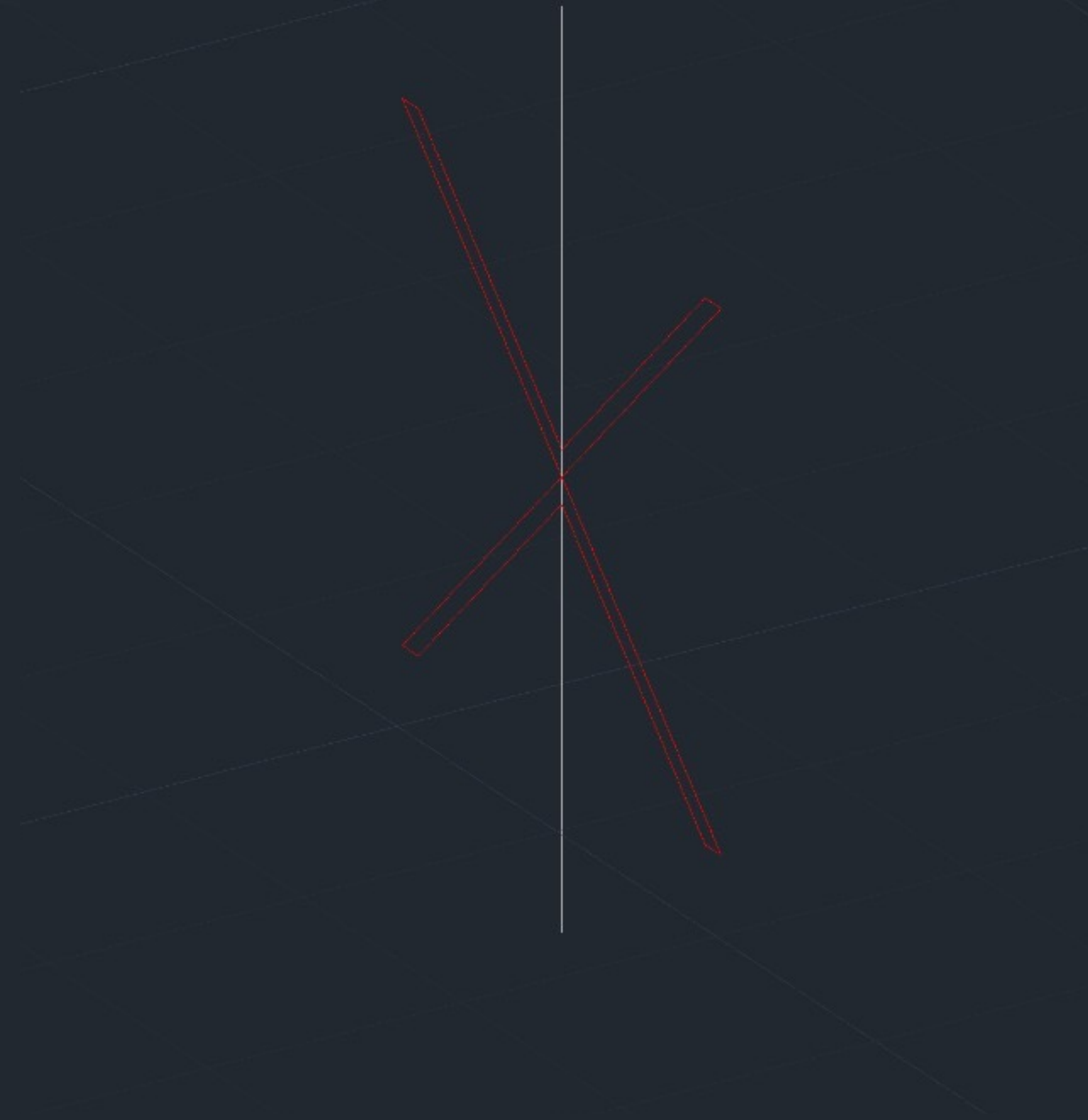

Exerc. 2.2–Superfícies de Revolução

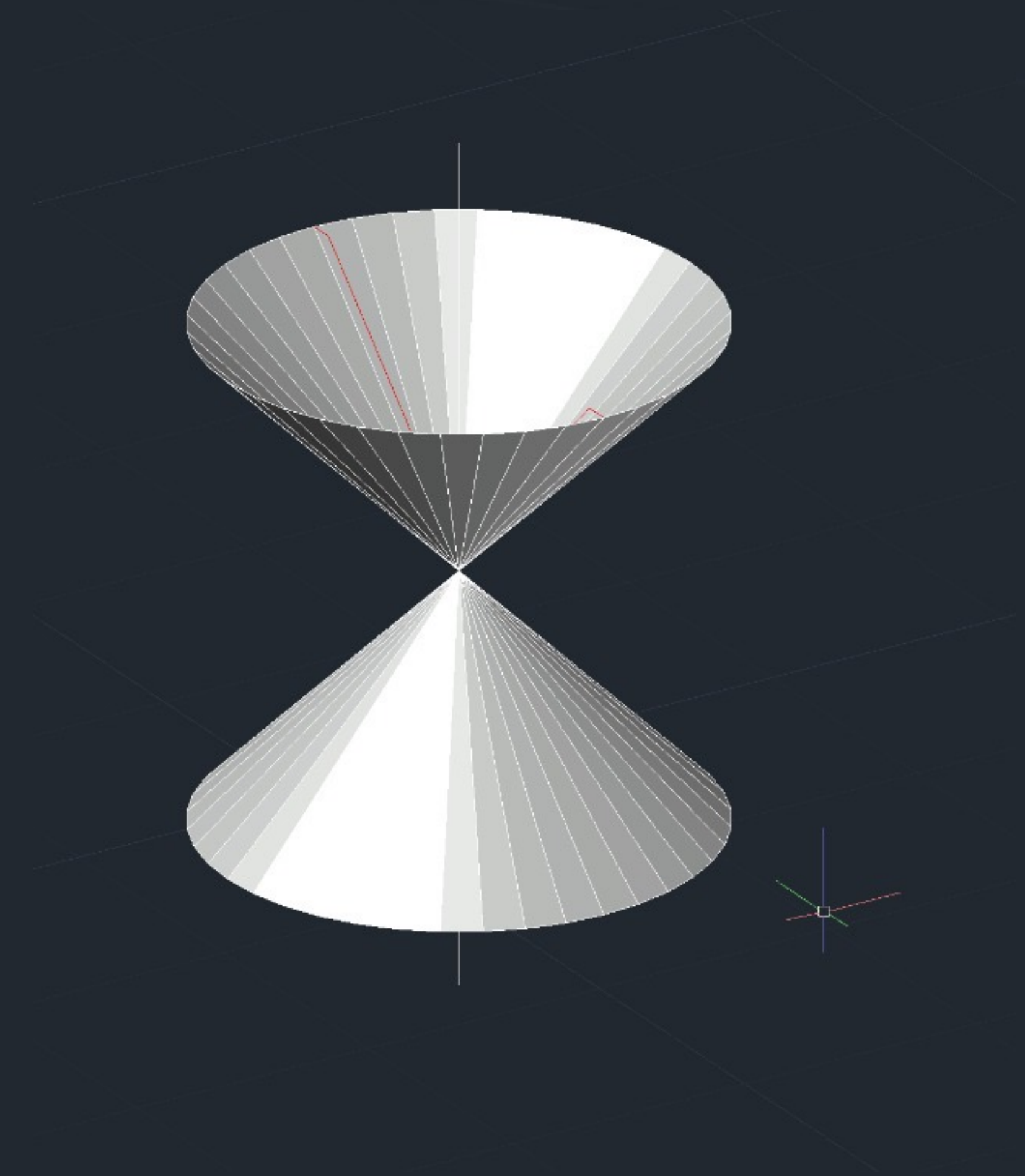

Exerc. 2.2 – Superfícies de Revolução

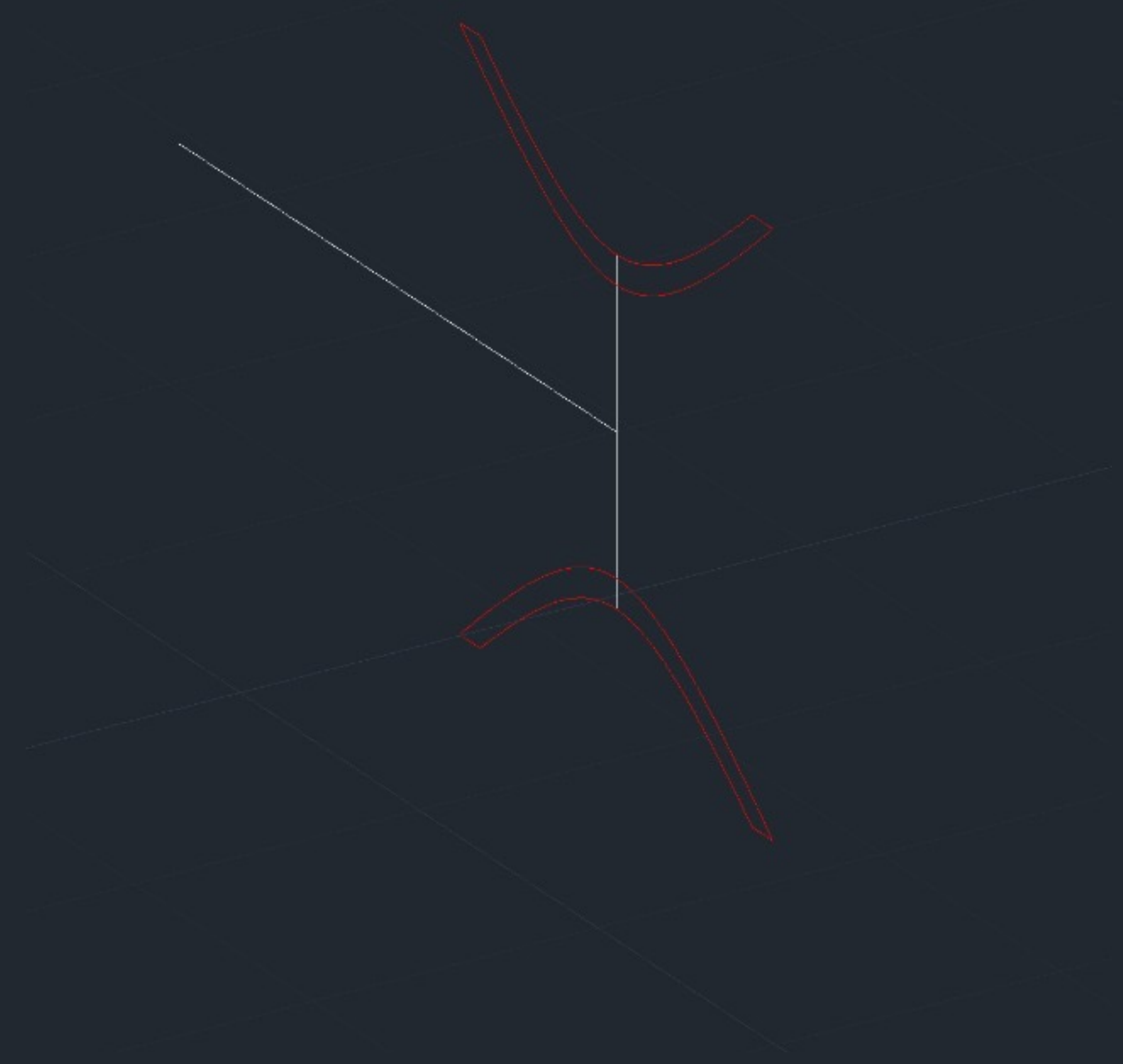

Exerc. 2.2 – Superfícies de Revolução

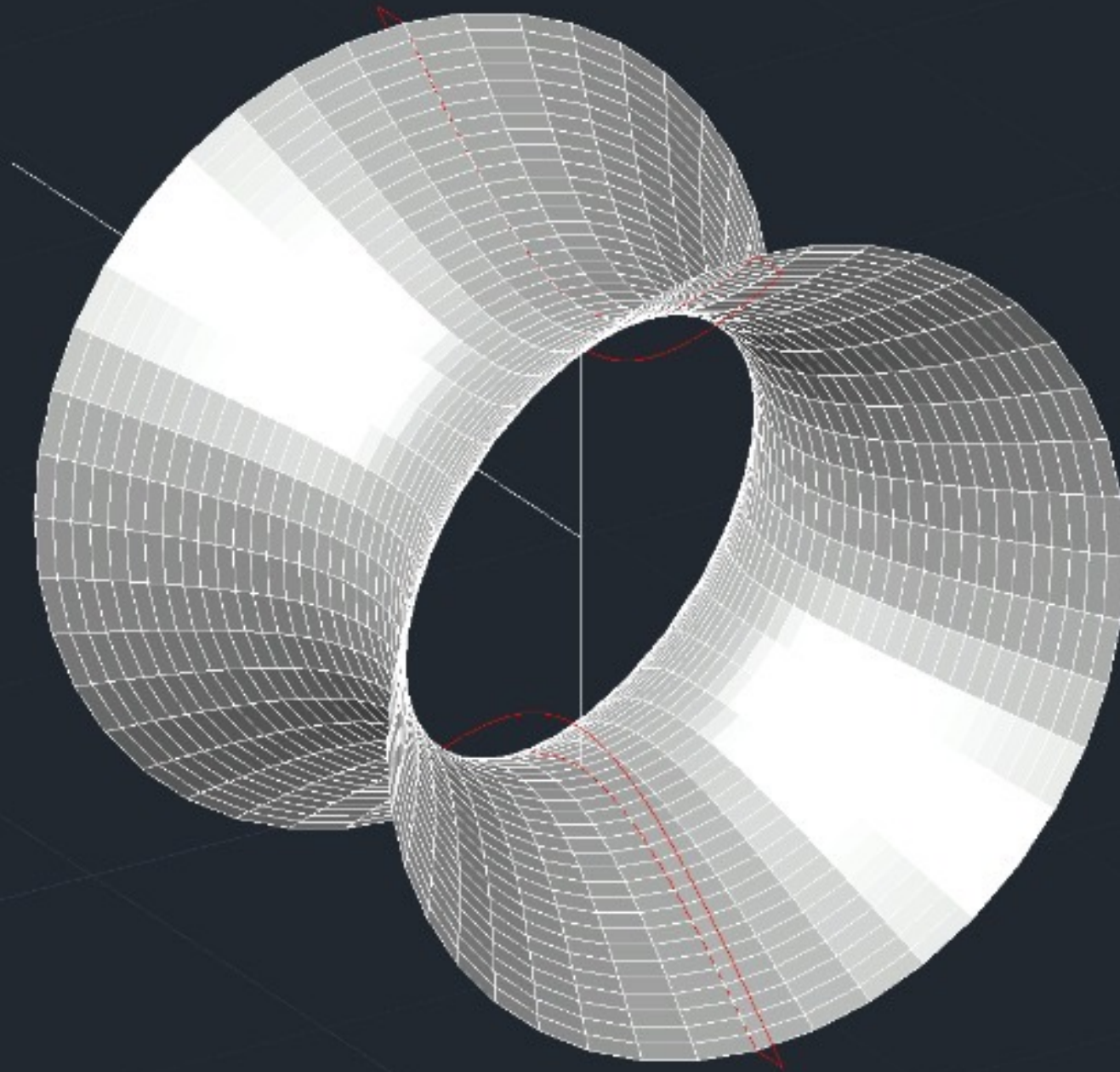

Exerc. 2.2 – Superfícies de Revolução

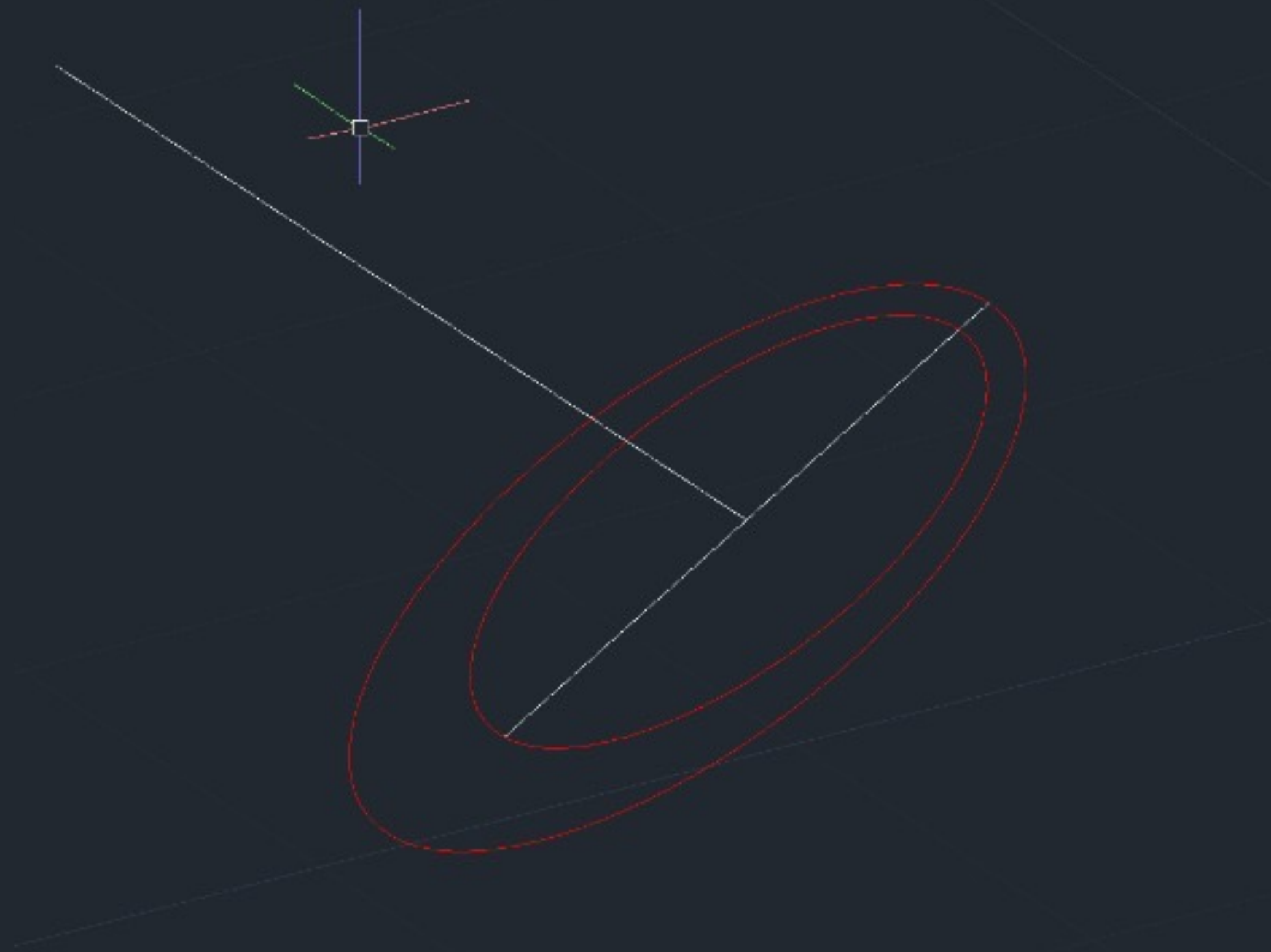

Exerc. 2.2 – Superfícies de Revolução

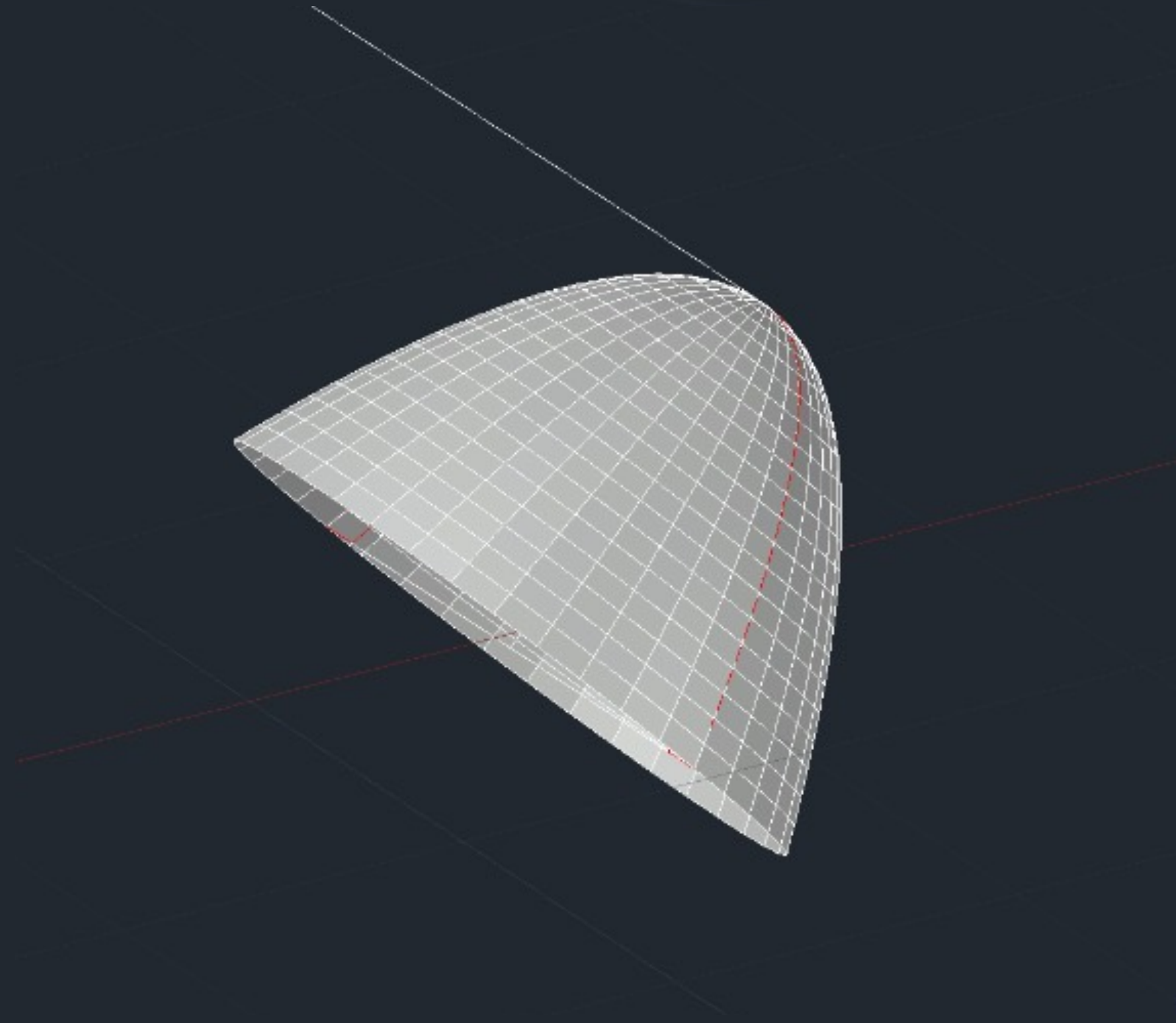

Exerc. 2.2 – Superfícies de Revolução

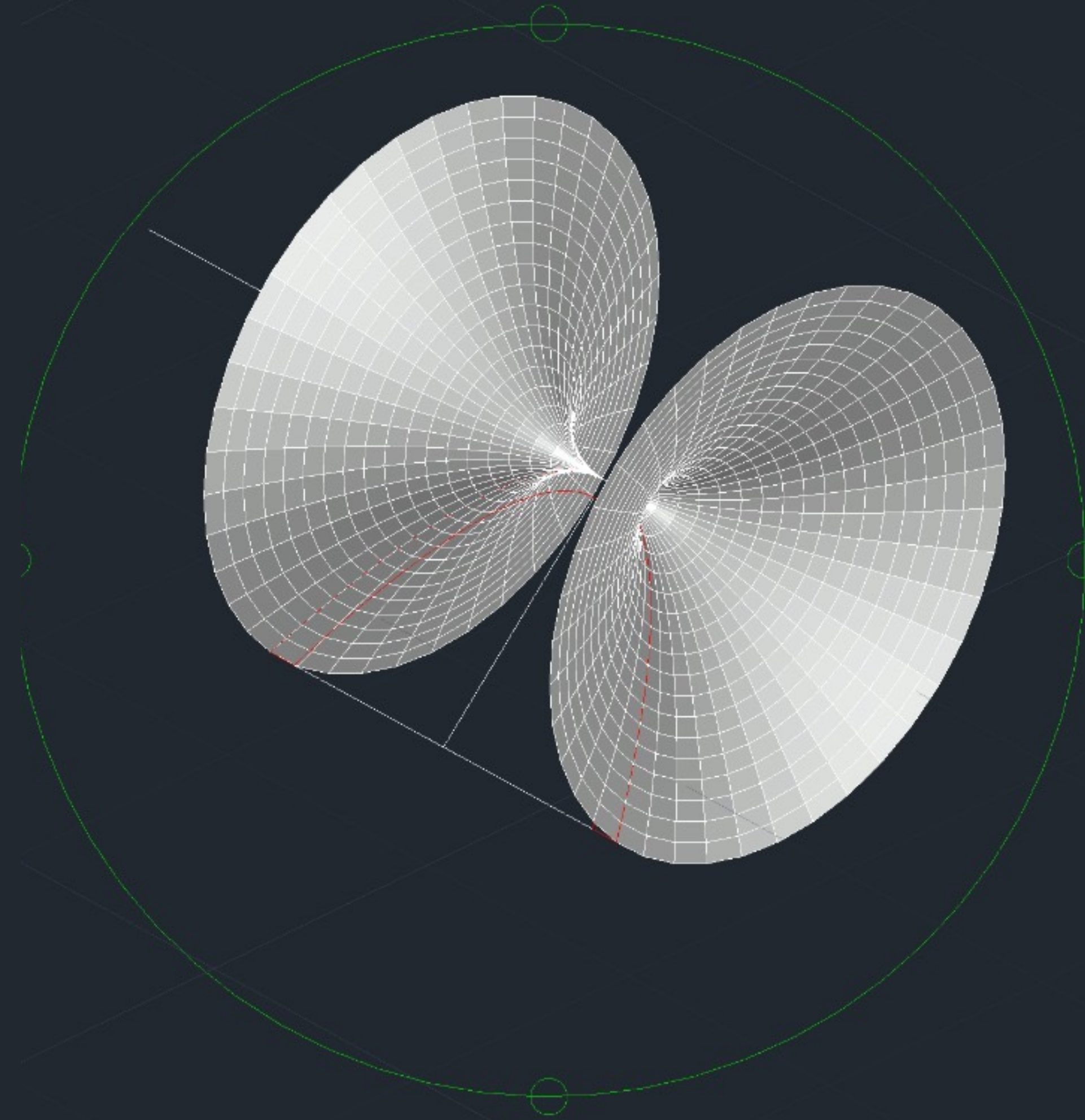

Exerc. 2.2–Superfícies de Revolução



Exerc. 2.2 – Superfícies de Revolução

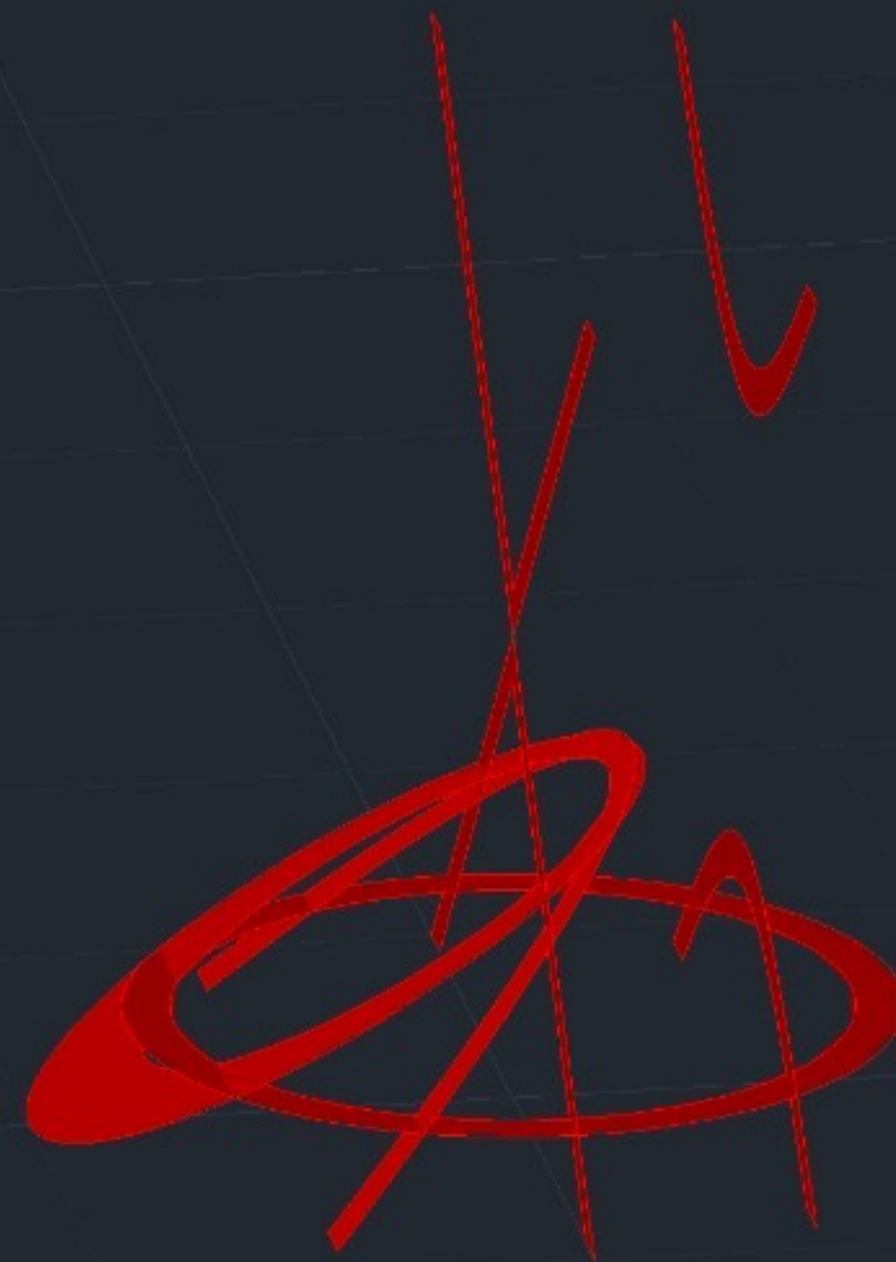

Exerc. 2.2 – Superfícies de Revolução

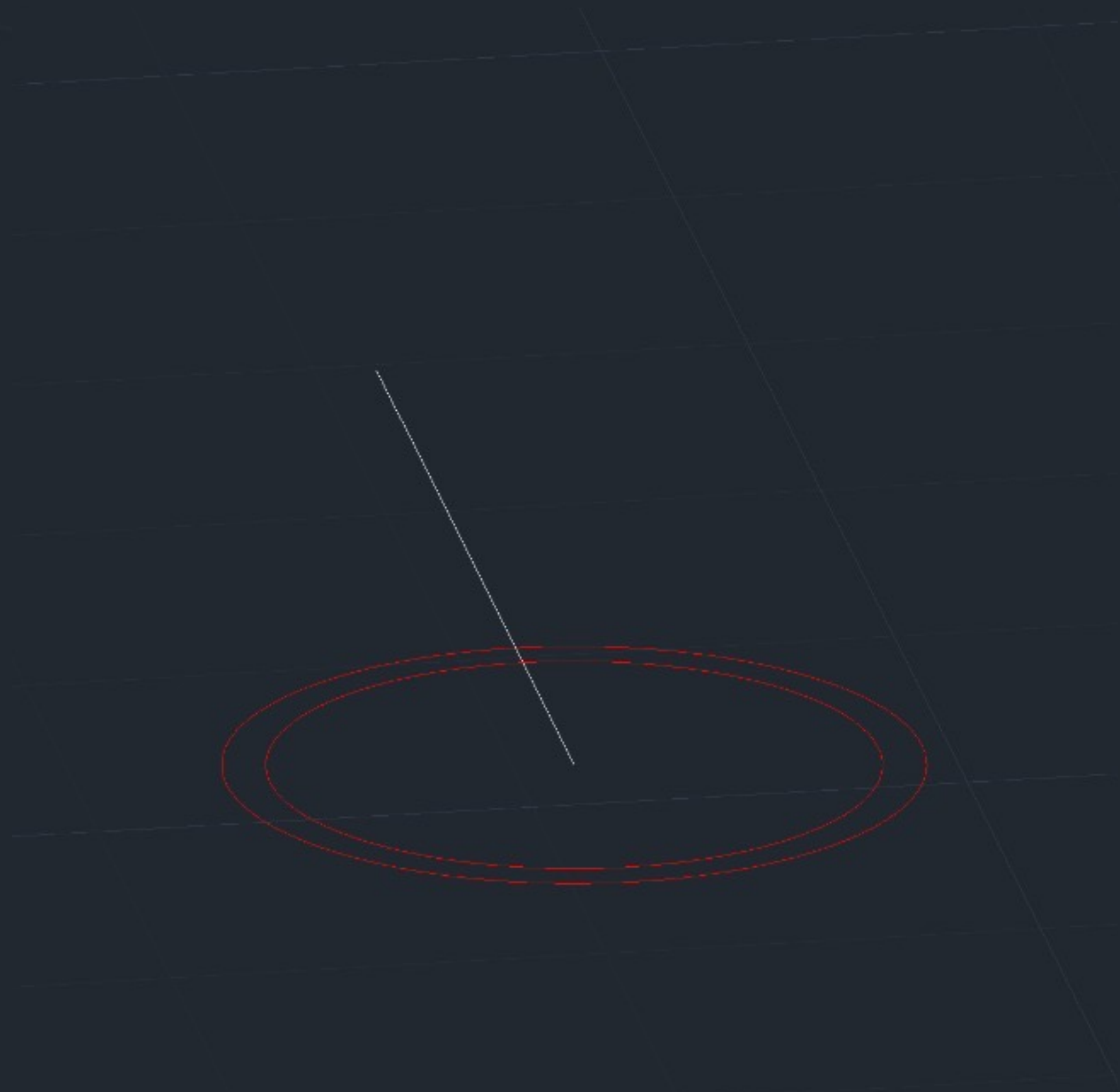

Exerc. 2.2 – Superfícies de Revolução

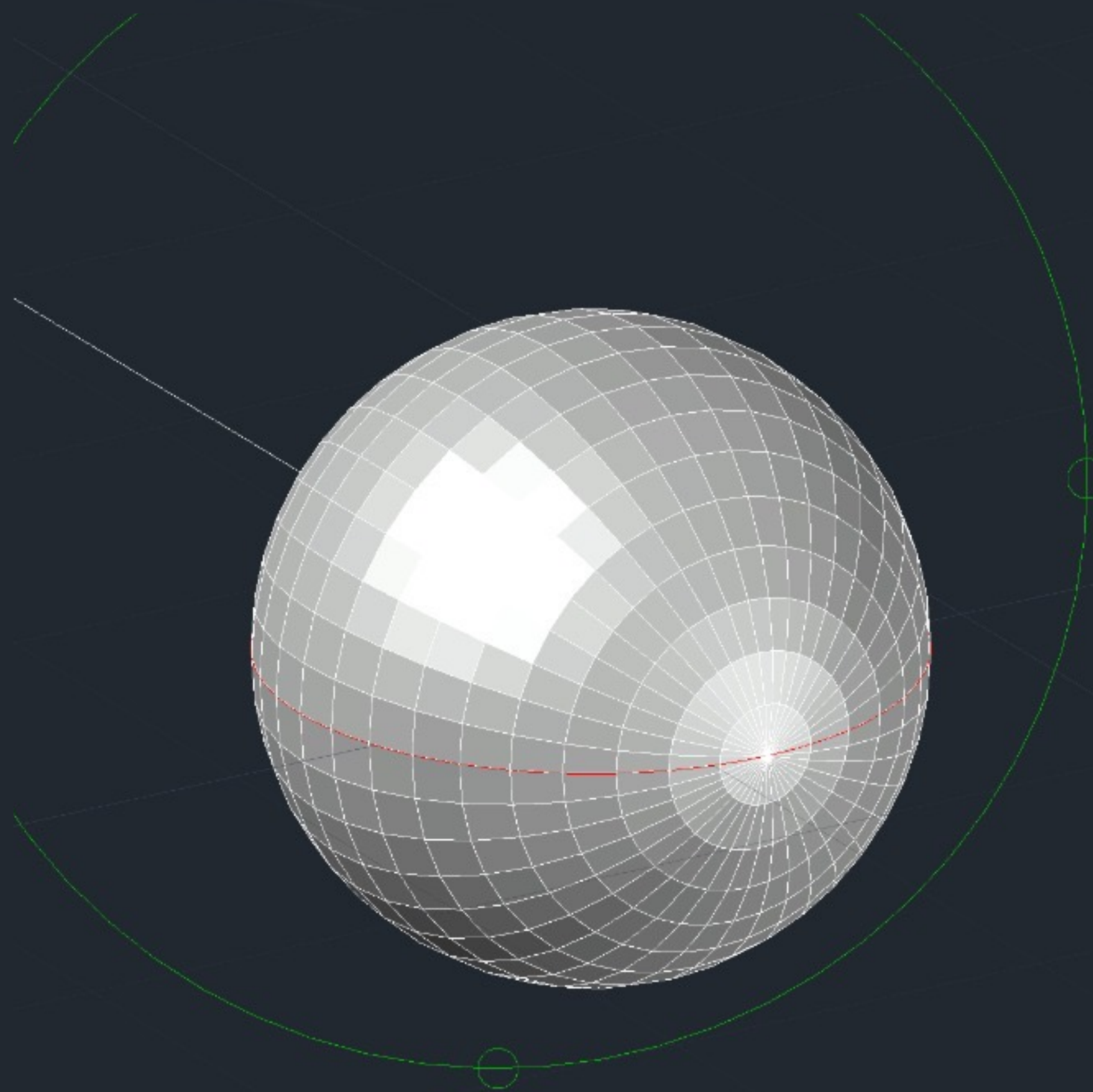

Exerc. 2.2 – Superfícies de Revolução

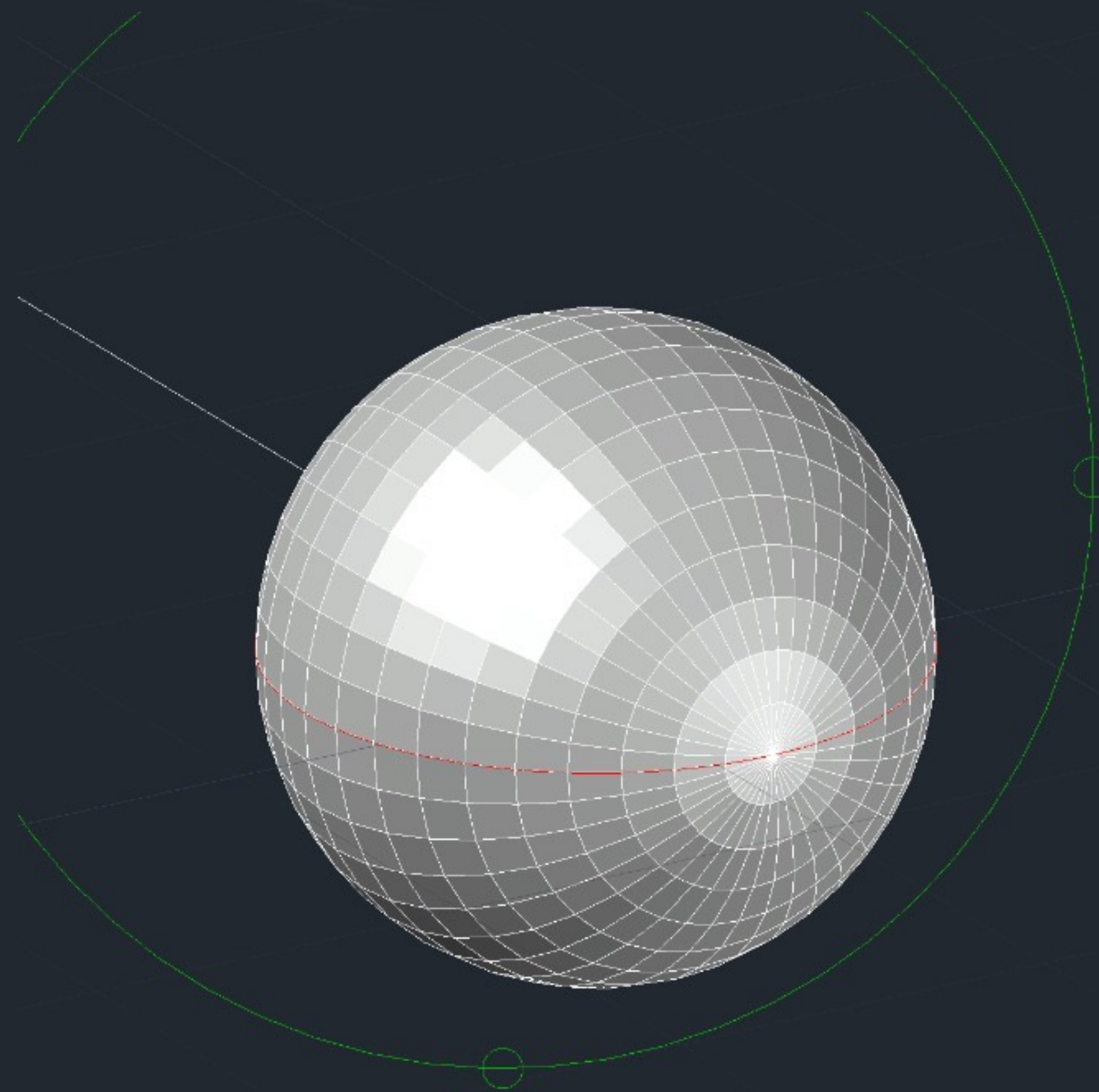

Exerc. 2.2 – Superfícies de Revolução

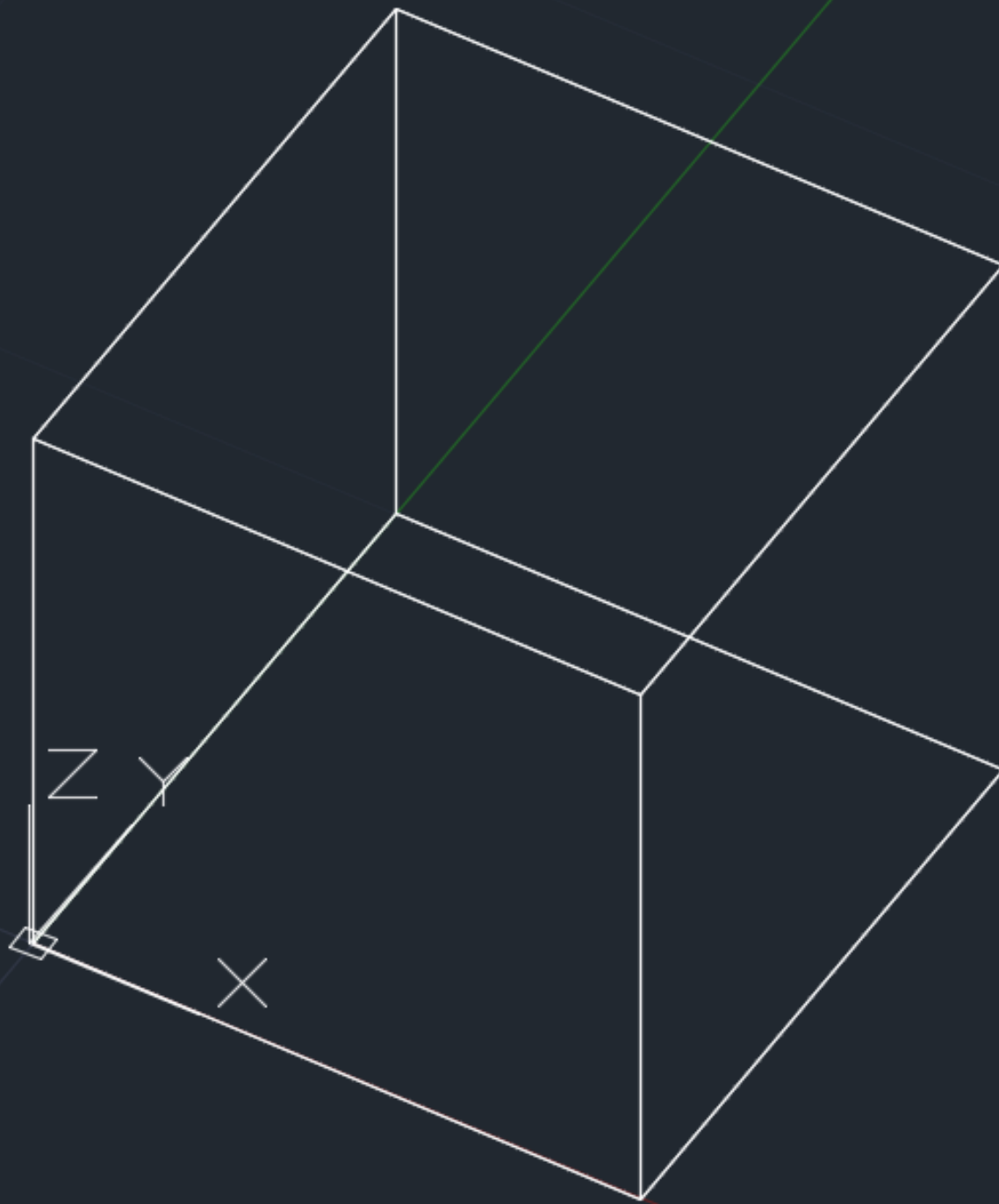

```
1 (Defun c:Xad ()  
2 (command "box" "0,0,0" "10,10,10")  
3 )  
4
```

Exerc. 3 – AutoLisp – Xadrez

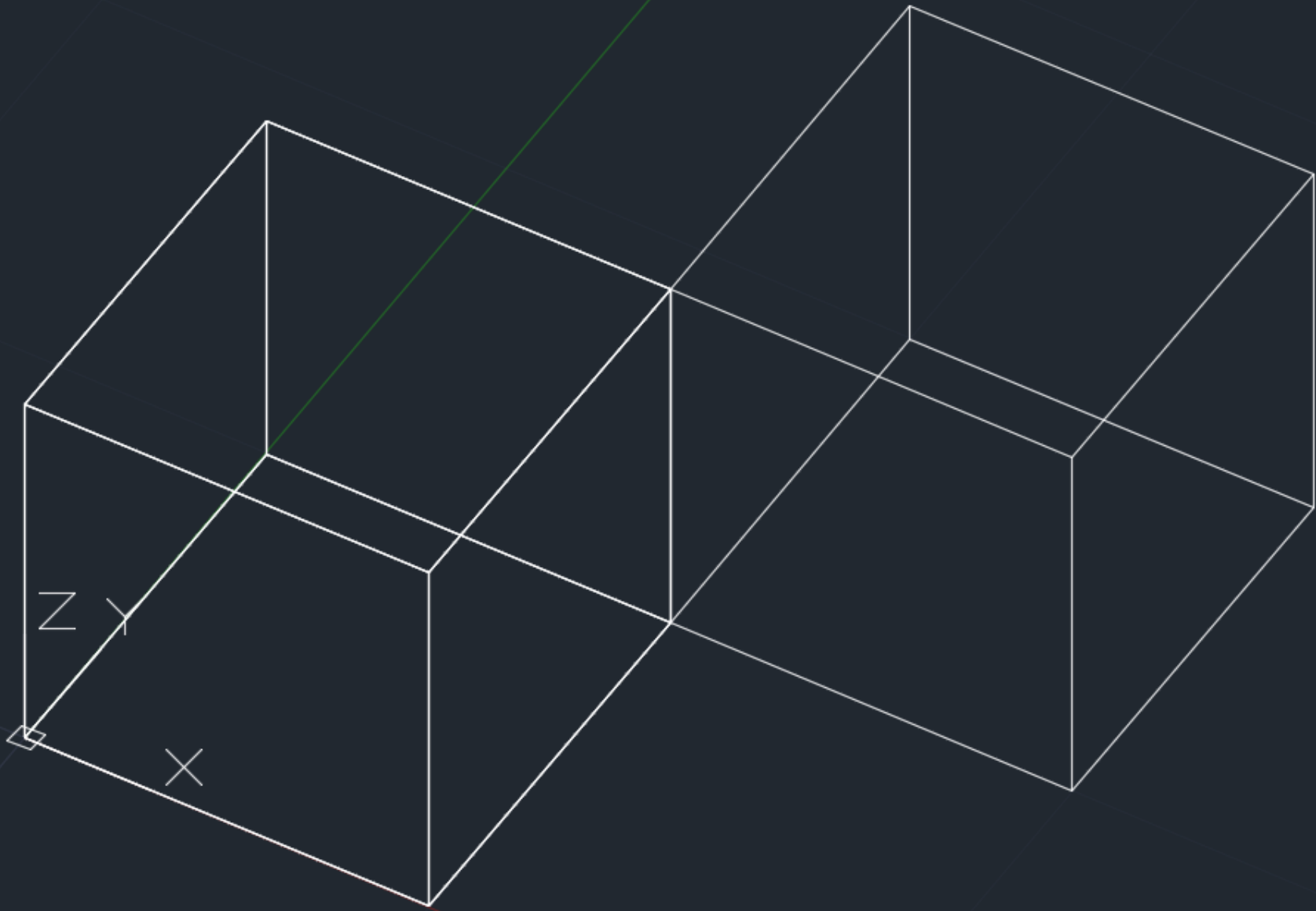

```
1 (Defun c:Xadrez ()  
2 (command "box" "0,0,0" "10,10,10")  
3 (command "copy" "last" "" "0,0,0" "10,10")  
4 )
```

Exerc. 3 – AutoLisp – Xadrez

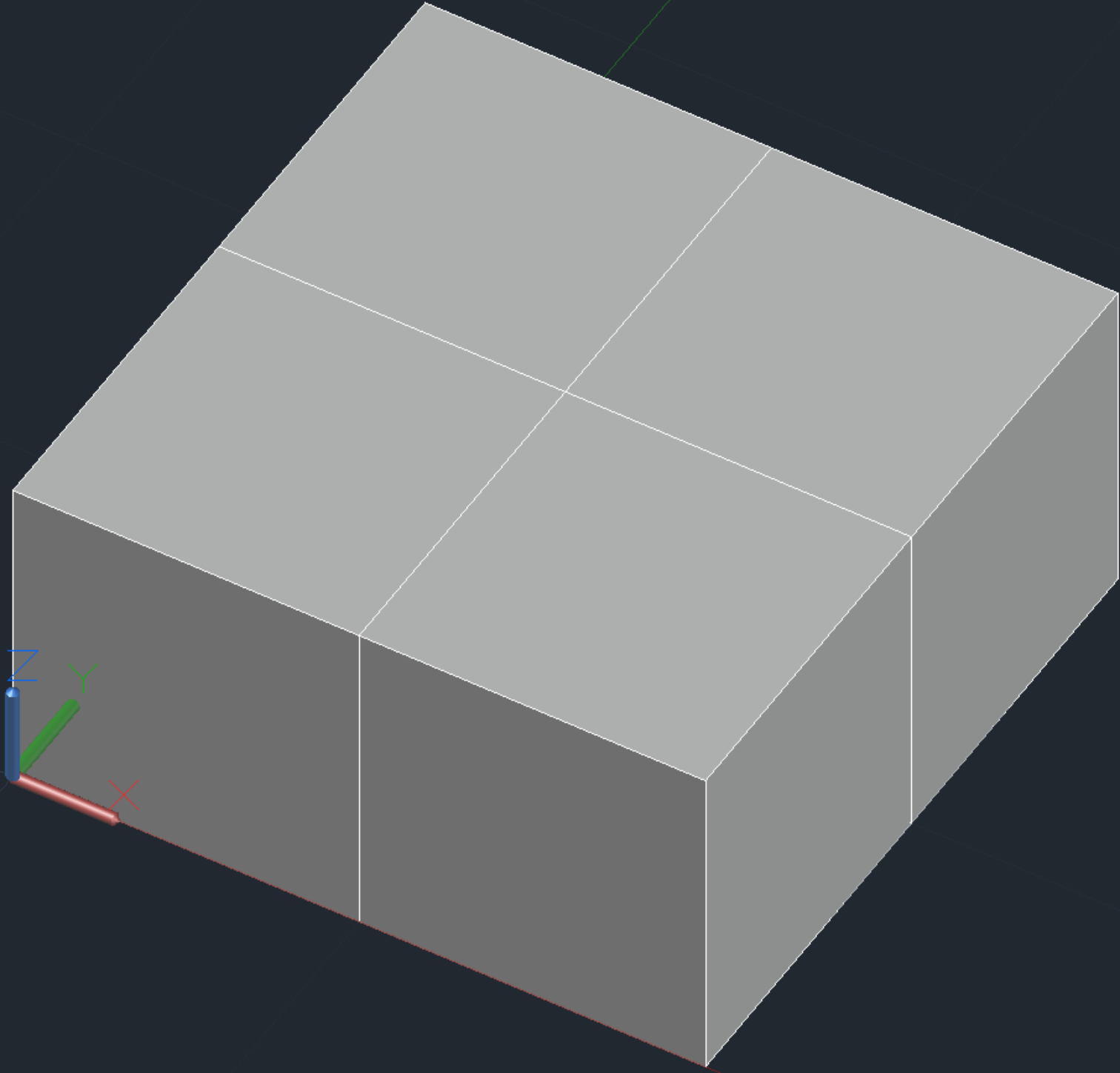

```
1 (Defun c:Xadrez ()  
2 (command "box" "0,0,0" "10,10,10")  
3 (command "copy" "last" "" "0,0,0" "10,10")  
4 (command "mirror" "all" "" "10,0" "10,10" "n")  
5 )
```

Exerc. 3 – AutoLisp – Xadrez

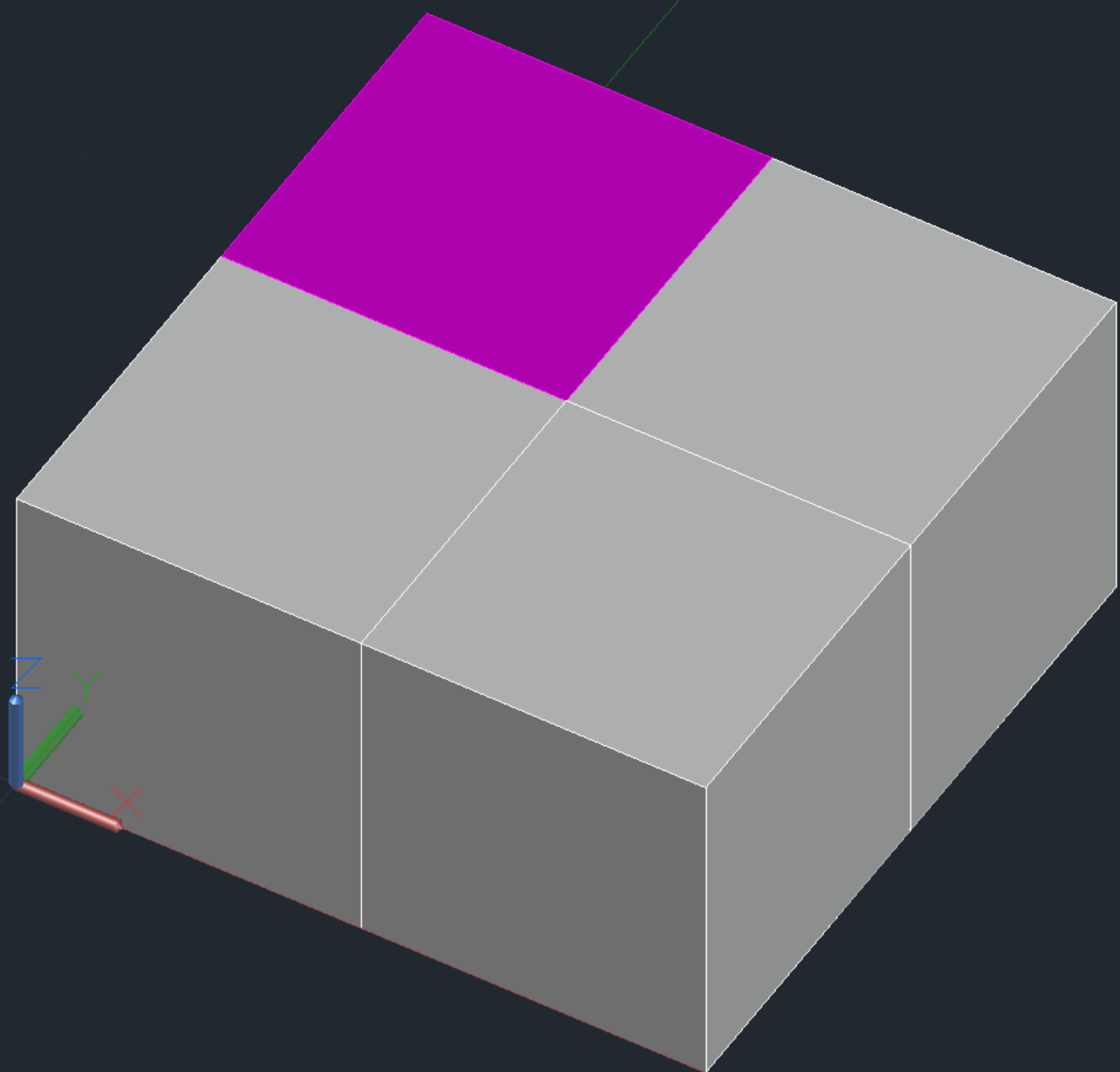

```
1 (Defun c:Xadrez ()  
2 (command "box" "0,0,0" "10,10,10")  
3 (command "copy" "last" "" "0,0,0" "10,10")  
4 (command "mirror" "all" "" "10,0" "10,10" "n")  
5 (command "chprop" "last" "" "c" "6" "")  
6 )
```

Exerc. 3 – AutoLisp – Xadrez

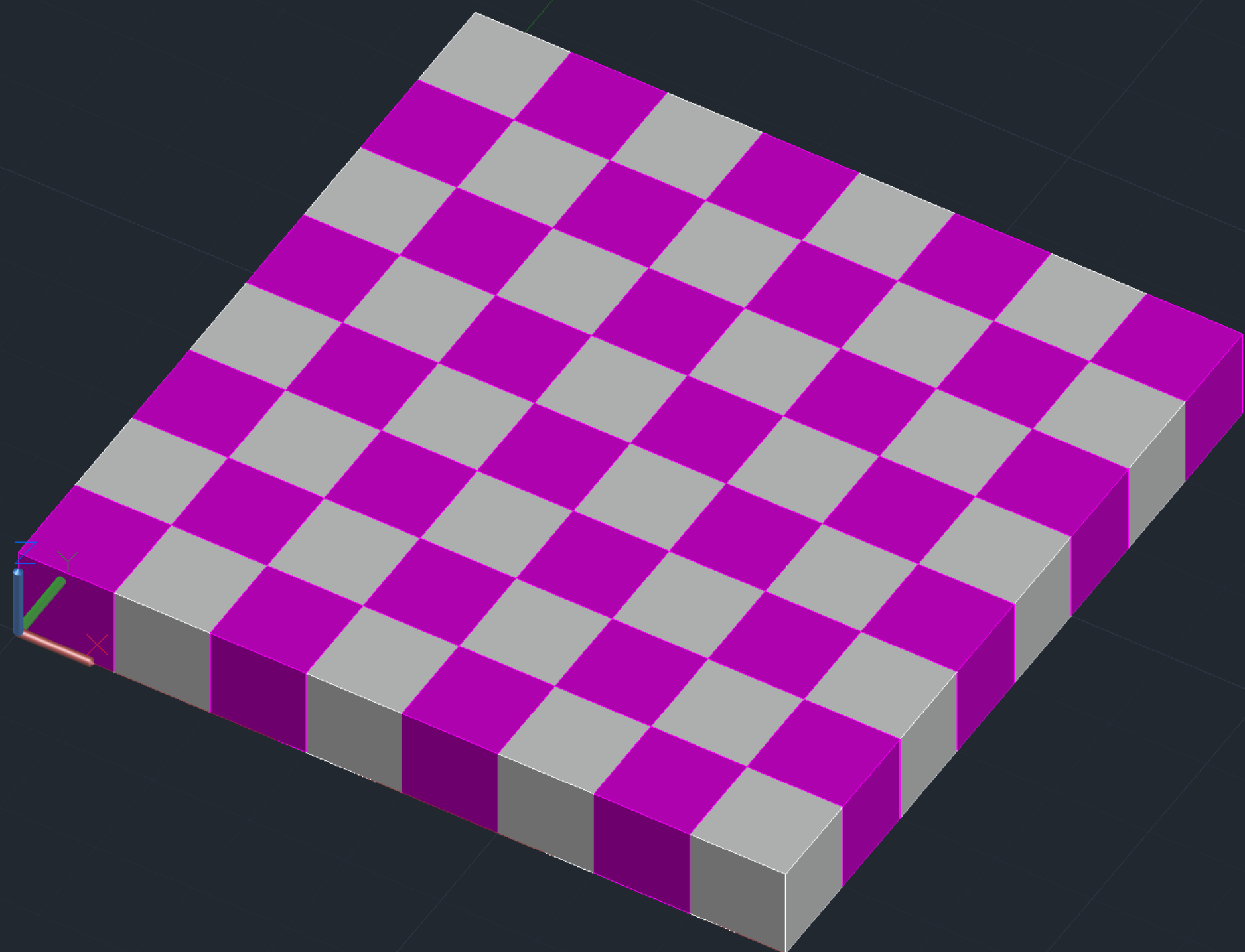

```
1 (Defun c:Xadrez ()  
2 (command "box" "0,0,0" "10,10,10")  
3 (command "copy" "last" "" "0,0,0" "10,10")  
4 (command "mirror" "all" "" "10,0" "10,10" "n")  
5 (command "chprop" "previous" "" "c" "6" "")  
6 (command "array" "all" "" "R" "4" "4" "20" "20")  
7 )  
8
```

Exerc. 3 – AutoLisp – Xadrez

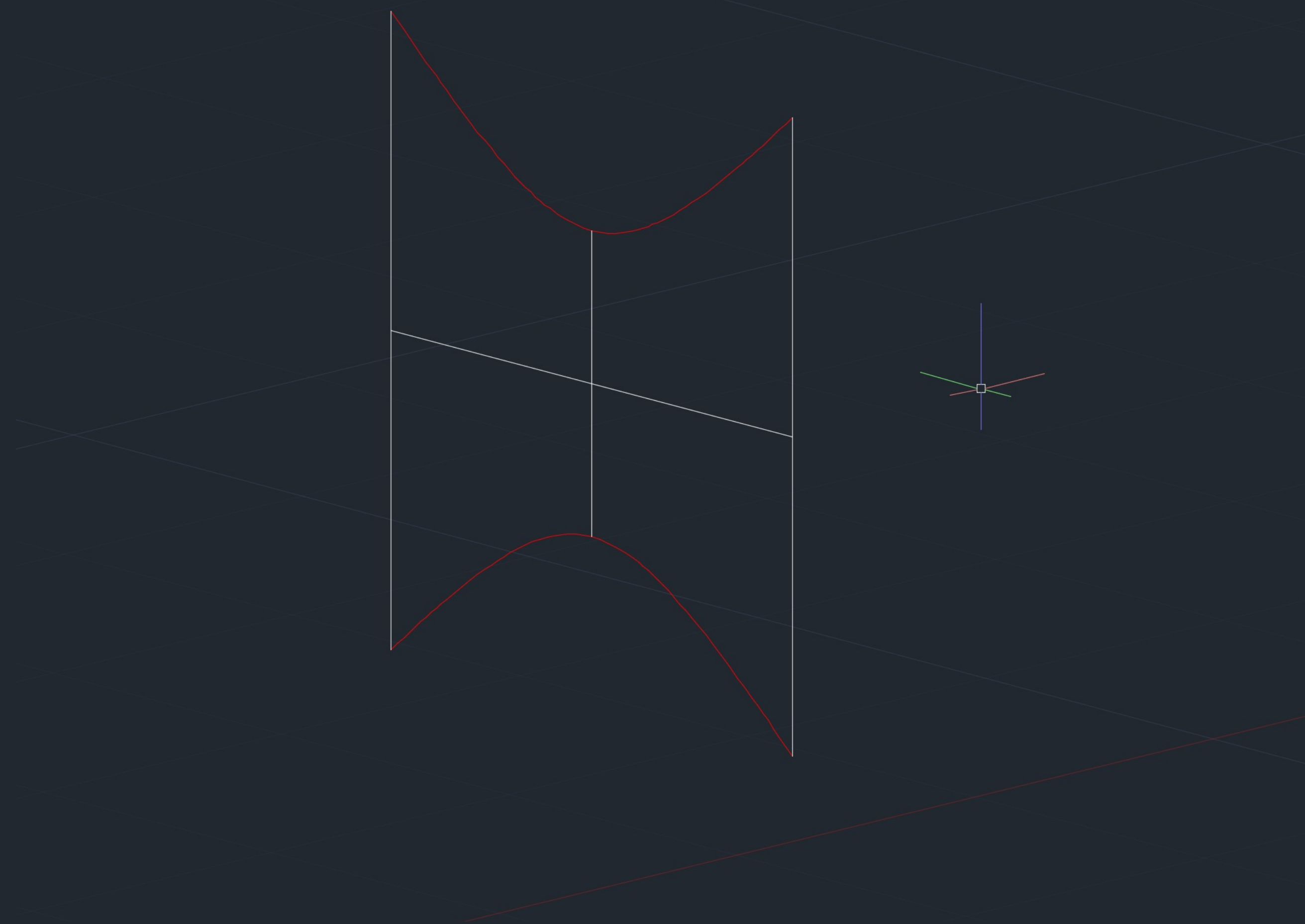

Exerc. 4.1 – Parabolóide Hiperbólico

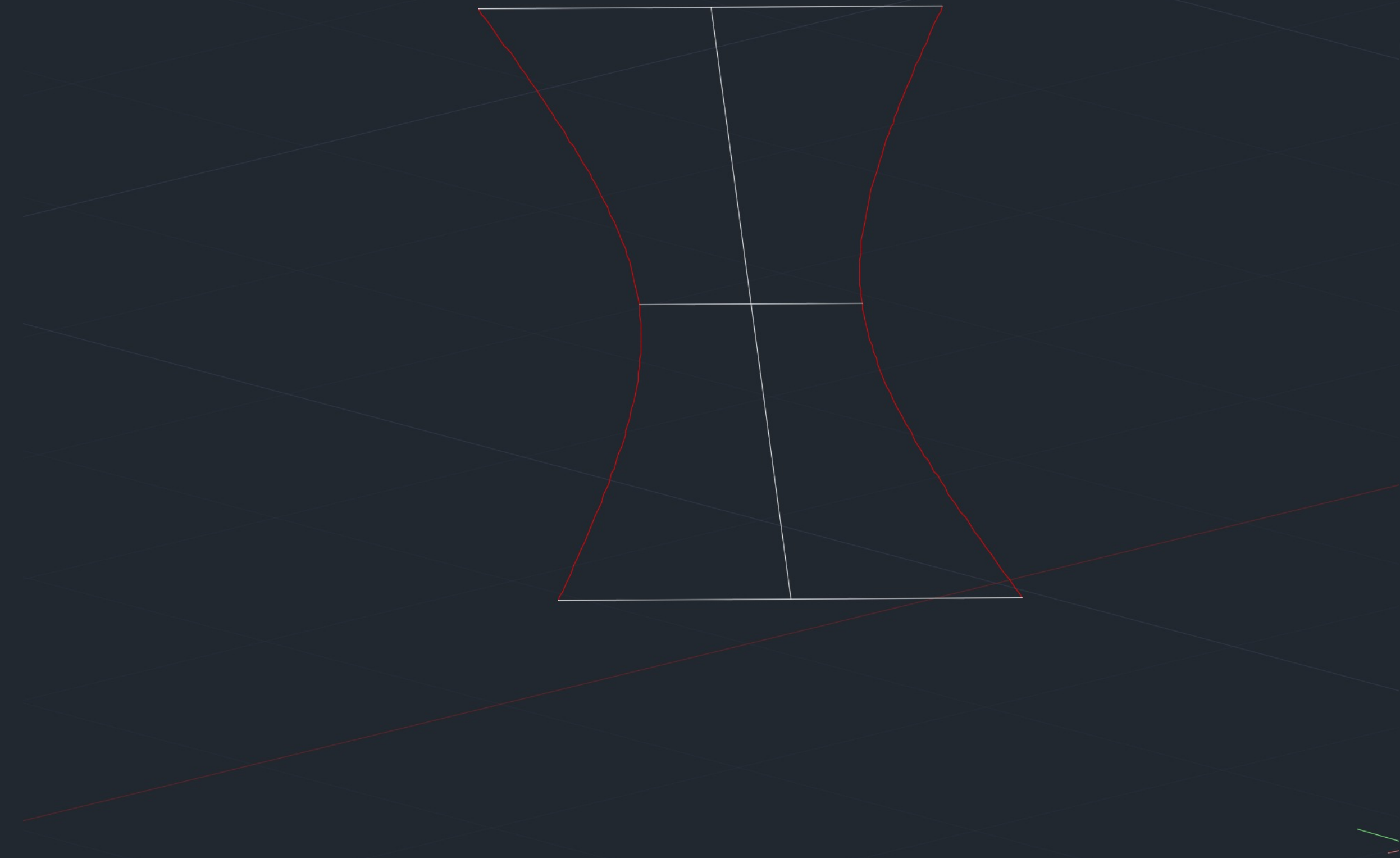

Exerc. 4.1 – Parabolóide Hiperbólico

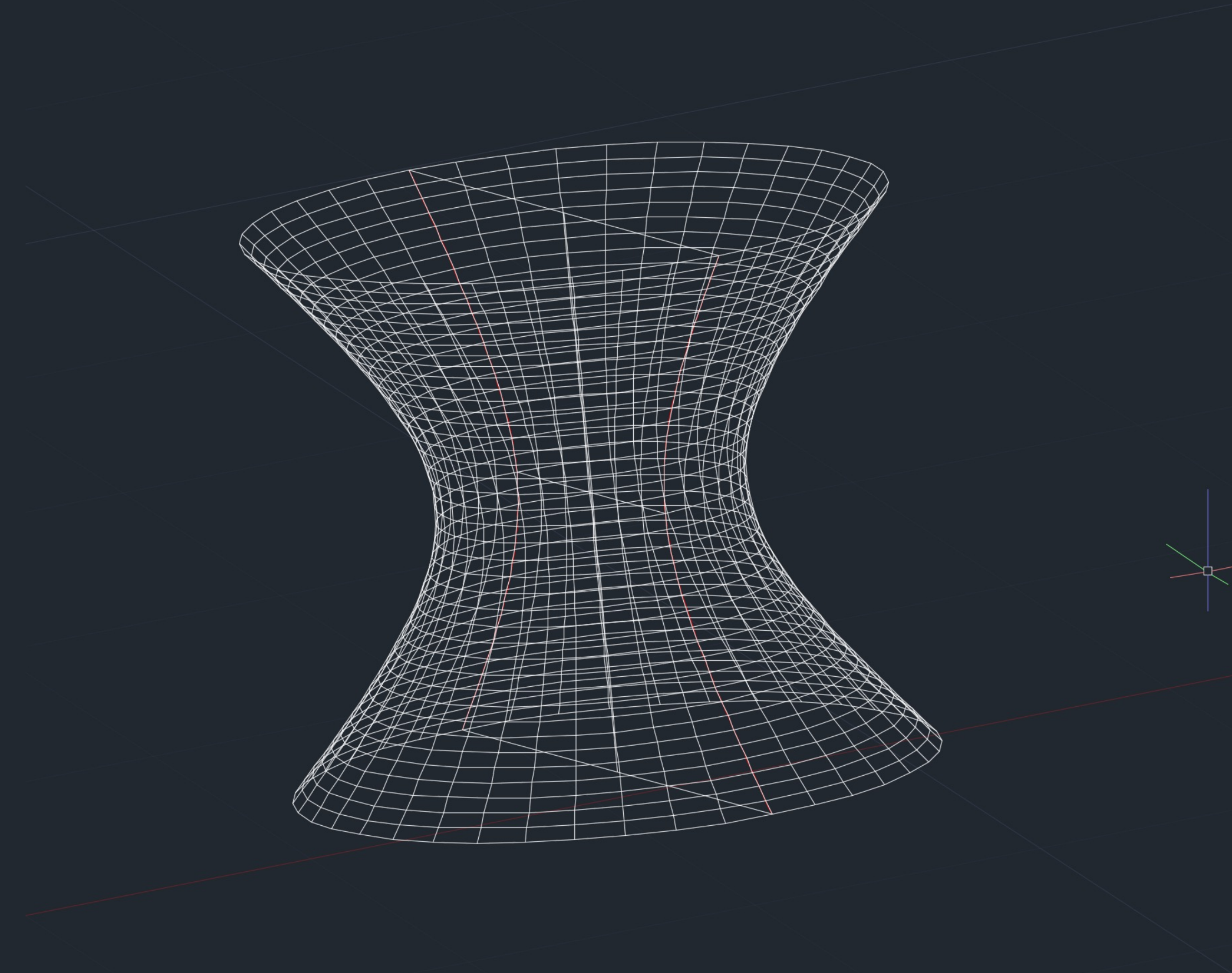

Exerc. 4.1 – Parabolóide Hiperbólico

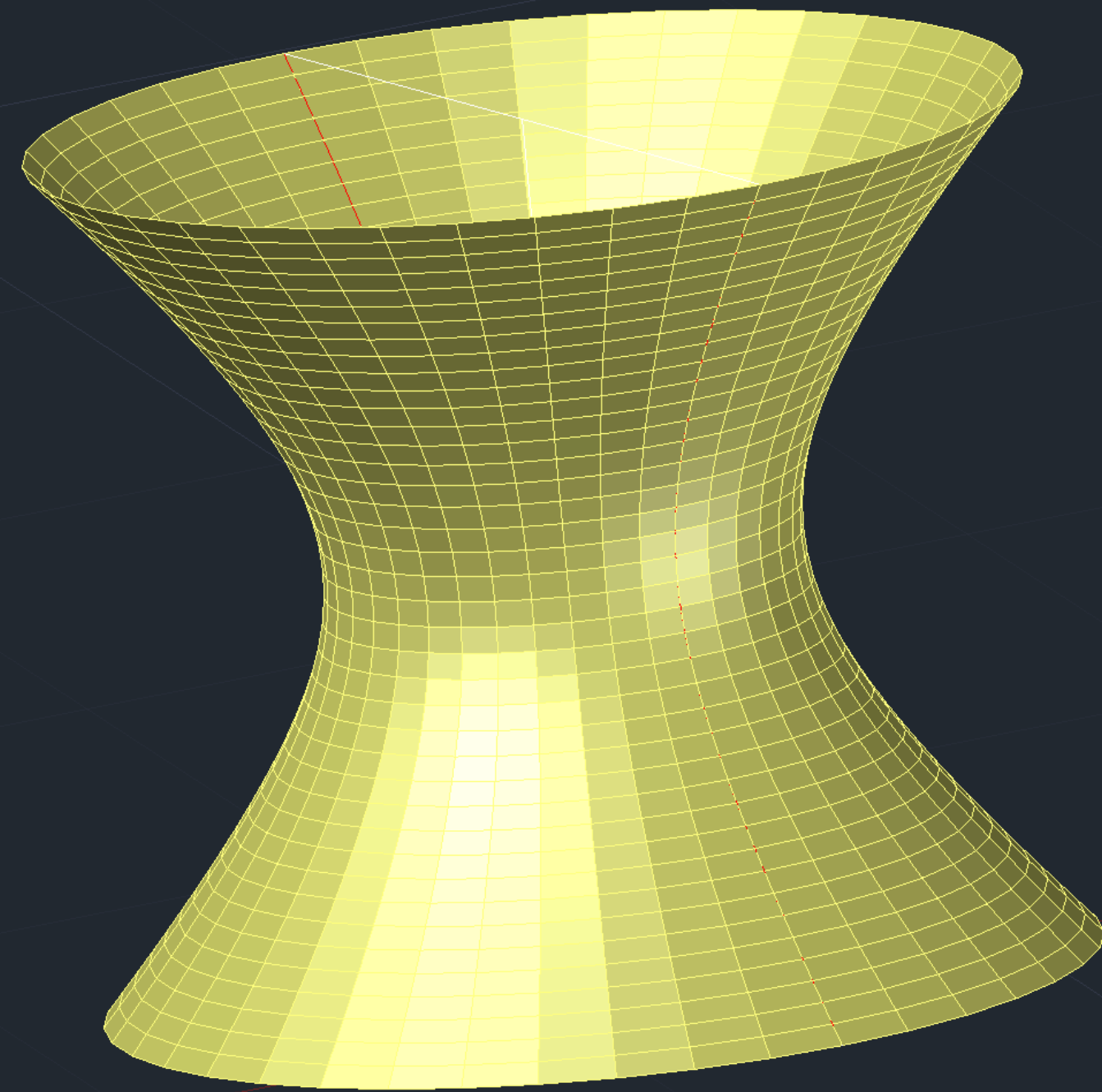

Exerc. 4.1 – Parabolóide Hiperbólico

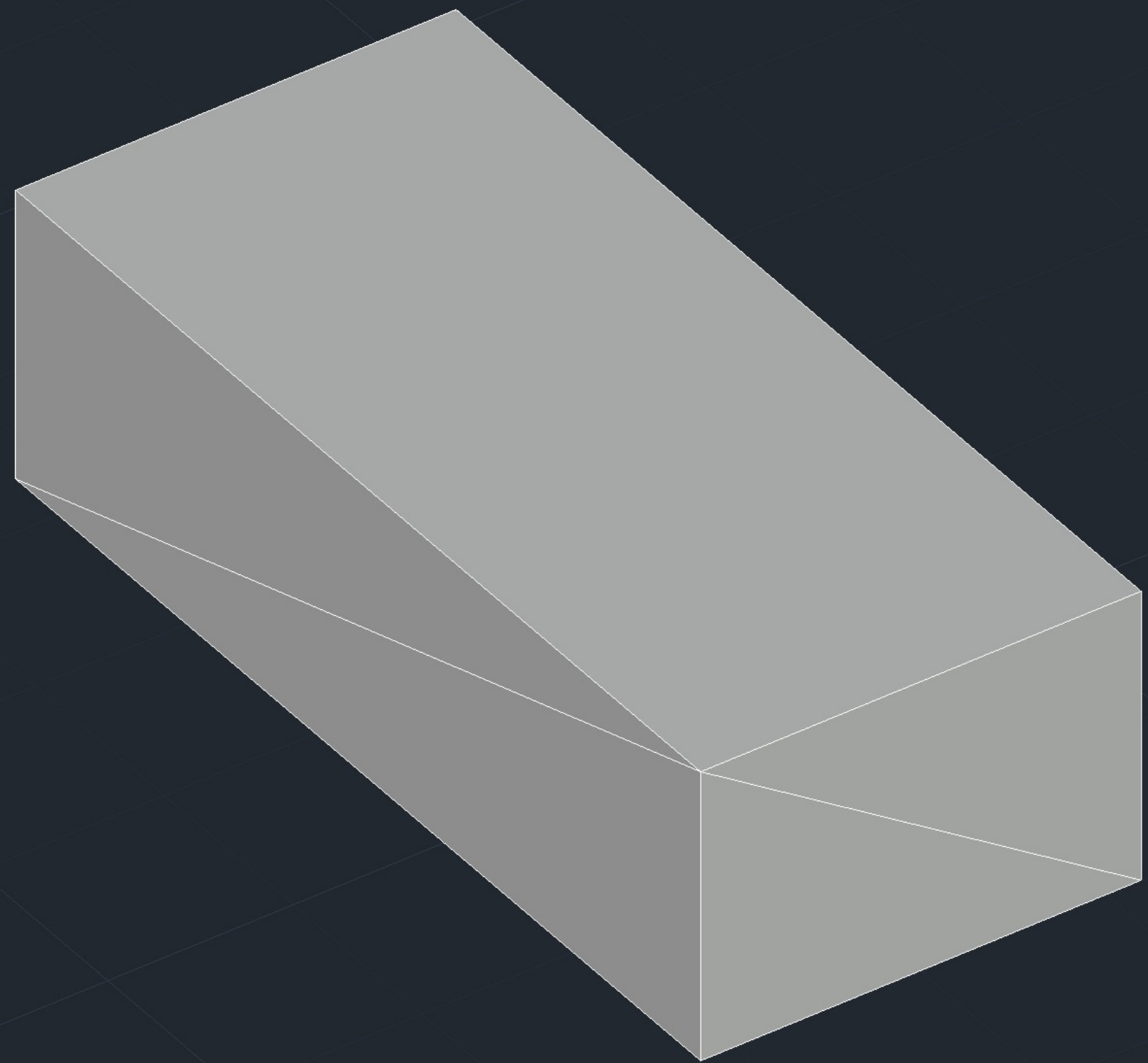

Exerc. 4.2 – Superficies - LOFT



Exerc. 4.2 – Superficies - LOFT

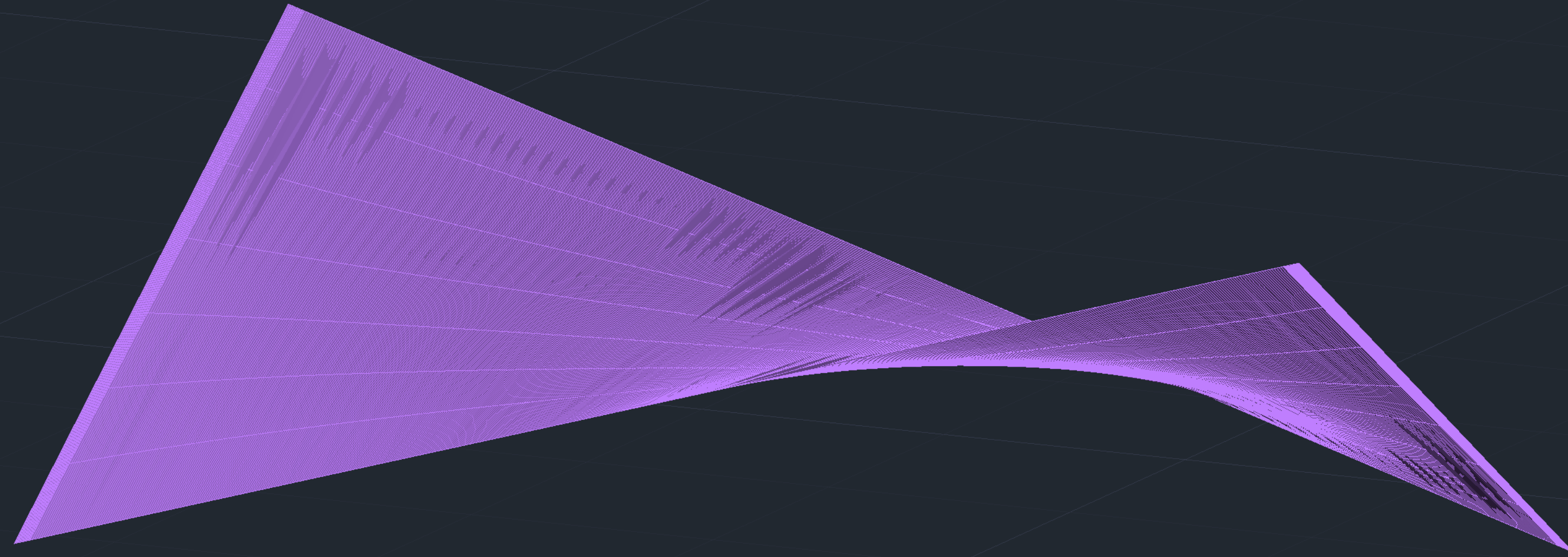

Exerc. 4.2 – Superficies - LOFT

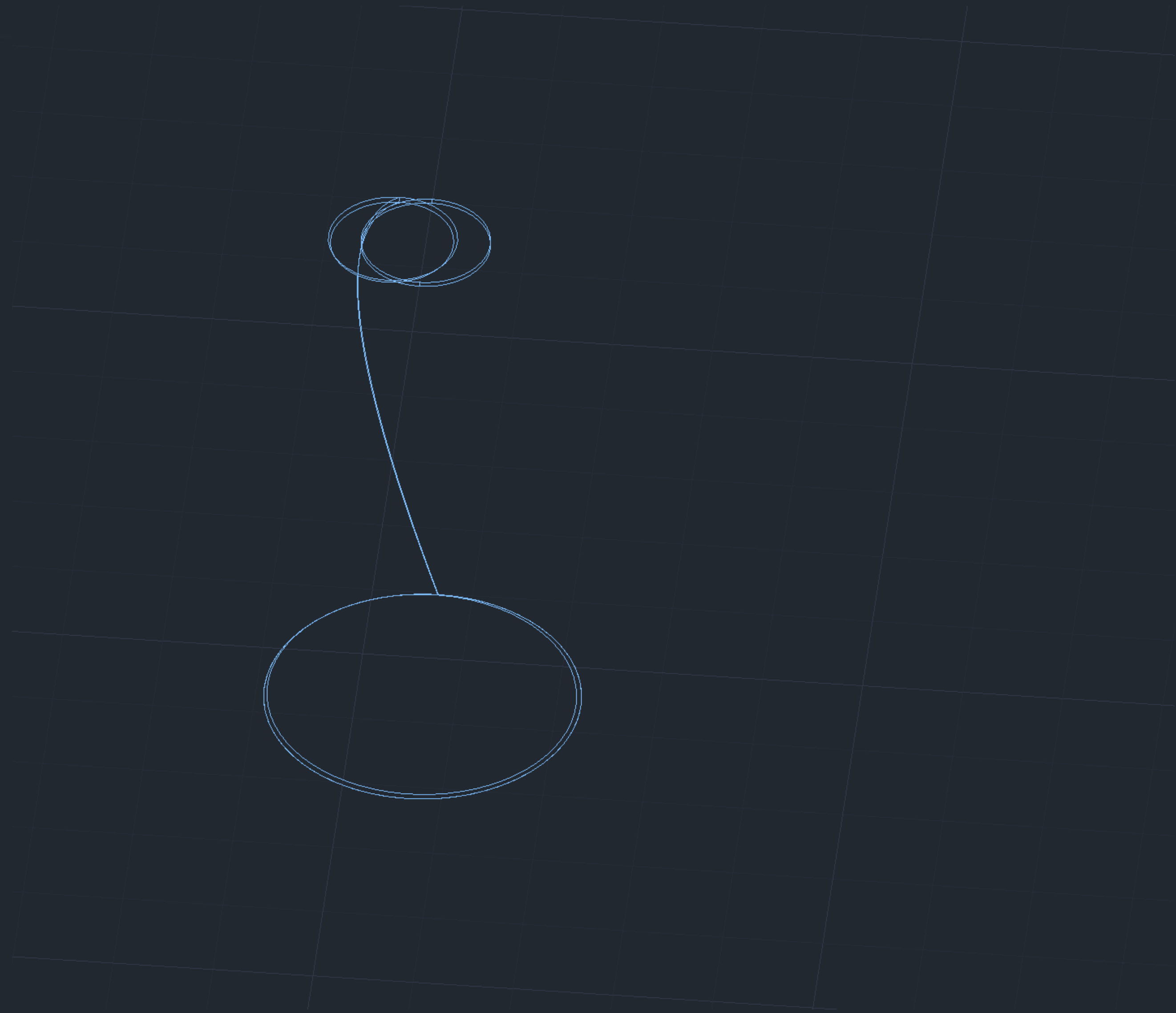

Exerc. 4.2 – Superficies - LOFT

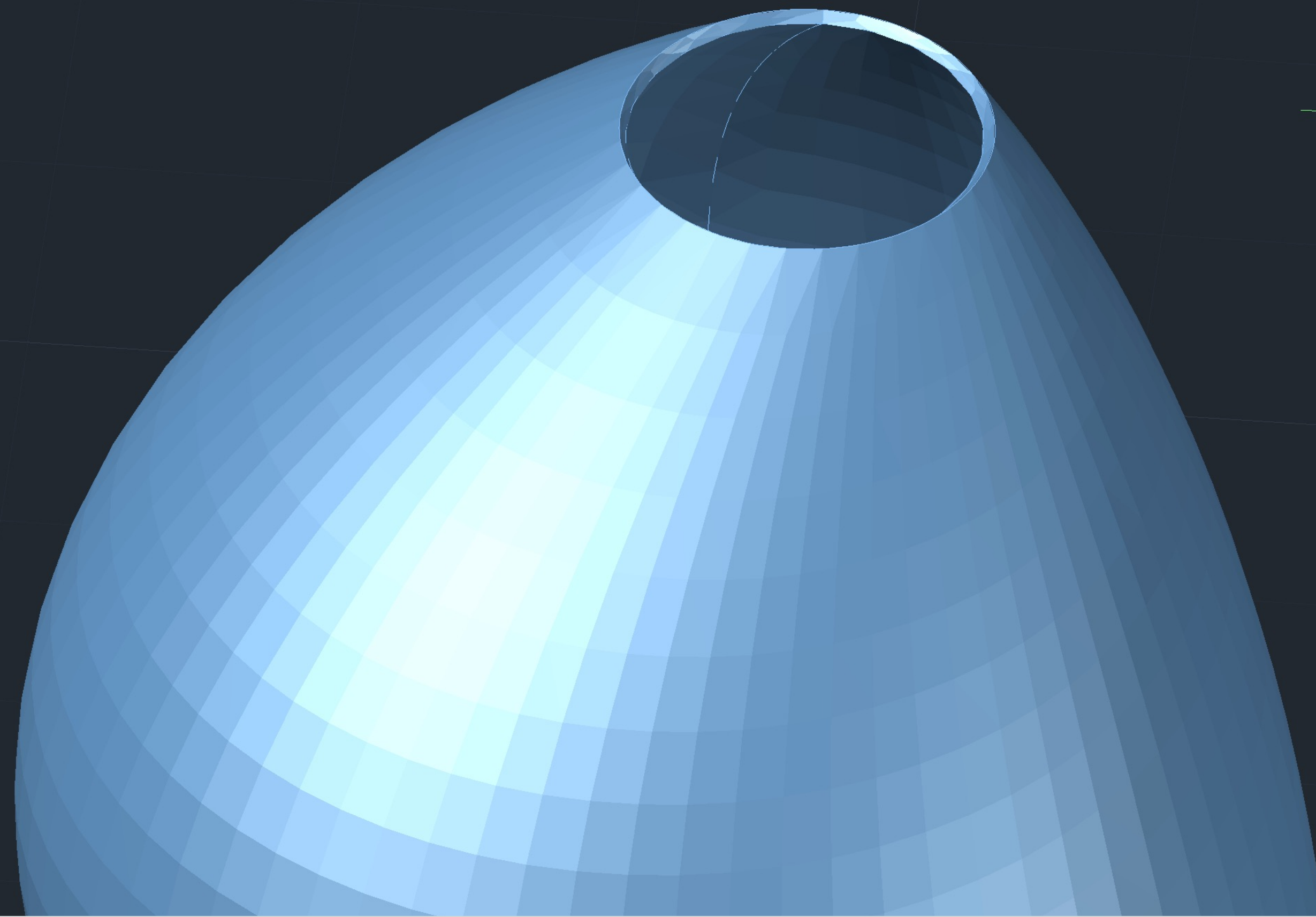

Exerc. 4.2 – Superficies - LOFT

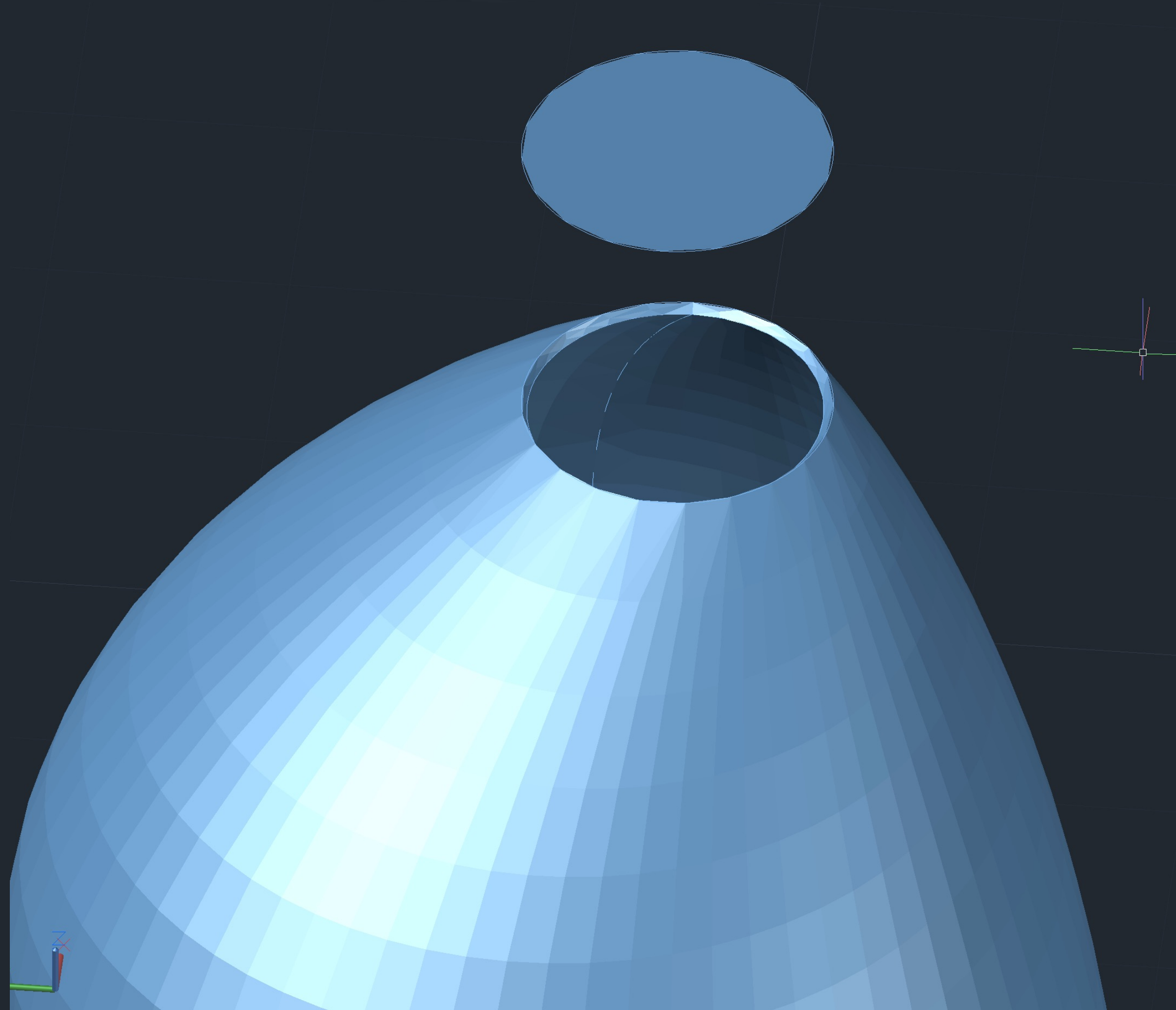

Exerc. 4.2 – Superfícies - LOFT

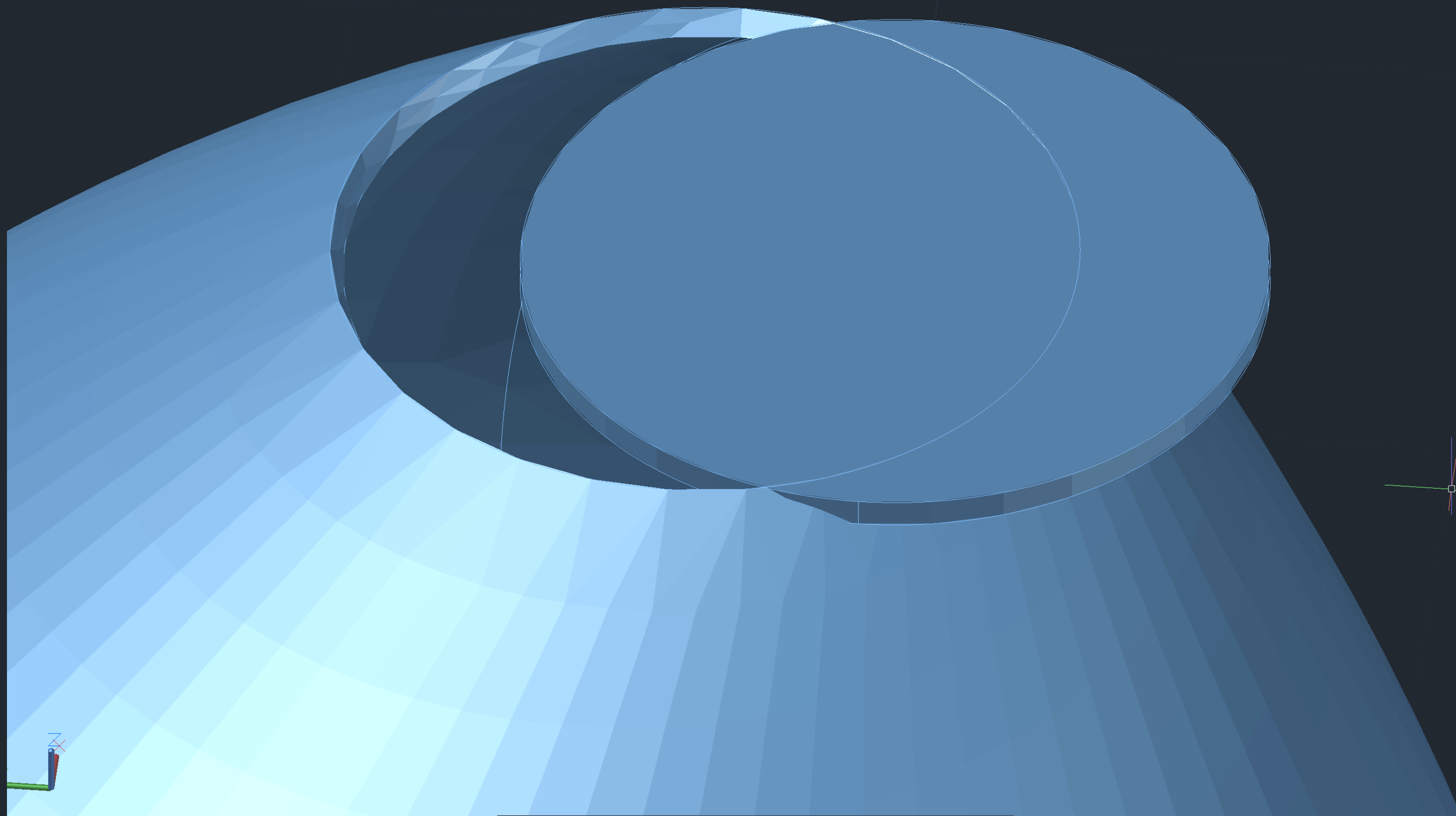

Exerc. 4.2 – Superficies - LOFT