

Modelação Geométrica e Generativa

20191202



INOCÊNCIO LEMOS

U LISBOA

UNIVERSIDADE
DE LISBOA

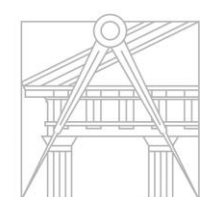

FACULDADE DE ARQUITETURA
UNIVERSIDADE DE LISBOA

MGeG

Mestrado Integrado em Arquitectura
Ano Lectivo 2022-2023 1º Semestre
Docente - Nuno Alão 4º Ano

ÍNDICE

- 1.QGIZ
 - 1.1- Mapa
- 2.Poliedros
 - 2.1.1- Cubo truncado
 - 2.1.2 Dual cubo
- 3.Conchas
 - 3.1 - Spirula
 - 3.2 - Planorbis
 - 3.3 – Nautilus
 - 3.4 – Caracol
 - 3.5 - Caramujo
- 4.Grasshopper
 - 4.1 – formas geométricas
 - 4.2 – formas geométricas
 - 4.3 – Plano curvo
 - 4.4 – Terreno Hipotético
 - 4.5 – Terreno Projeto
- 5.Conchas Bivalves
 - 5.1 – Mexilhão
 - 5.2 – Ameijoa
 - 5.3 – Vieira
 - 5.4 – Ostras
- 7.Corais
 - 7.1- Coral 1
 - 7.3 – Coral 3
 - 7.4- Coral 4



Exerc. qgis

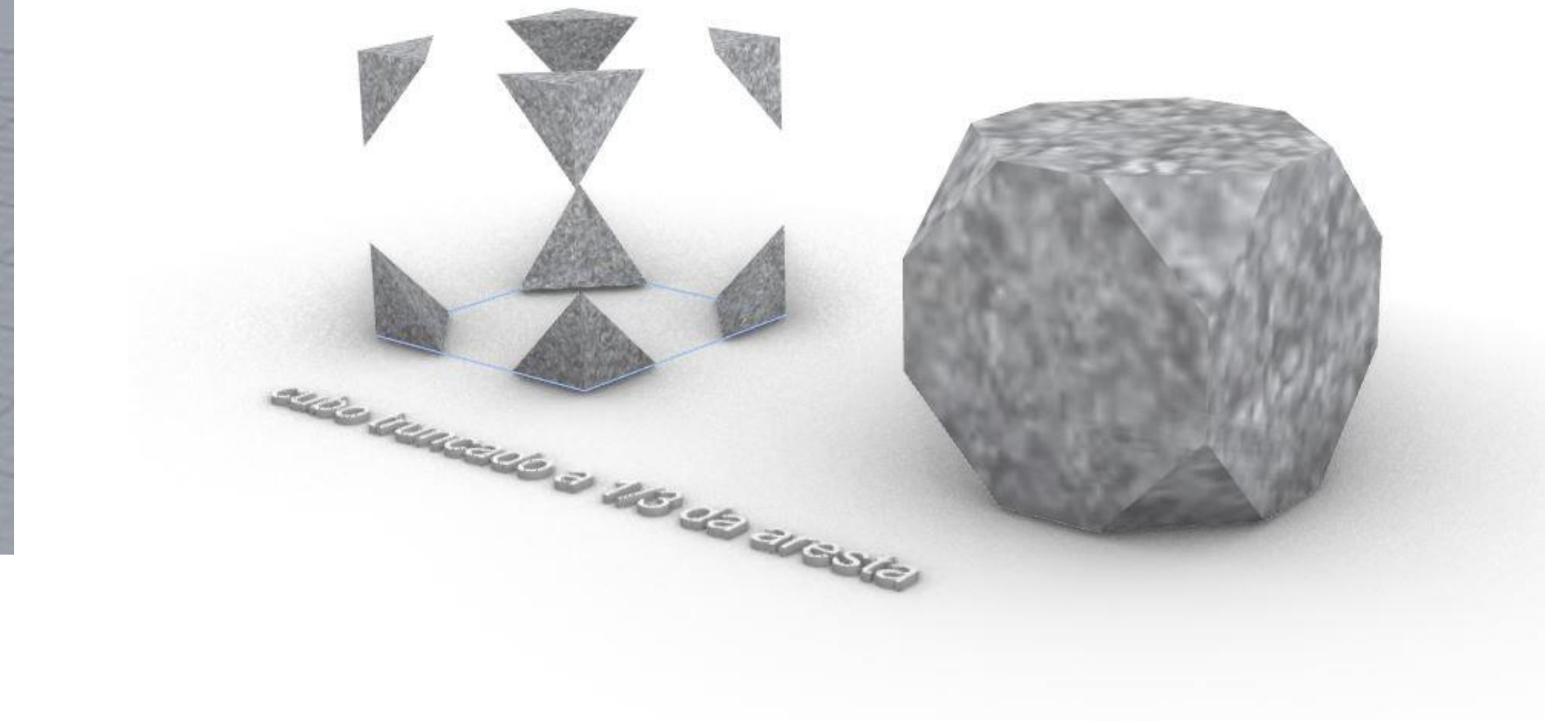
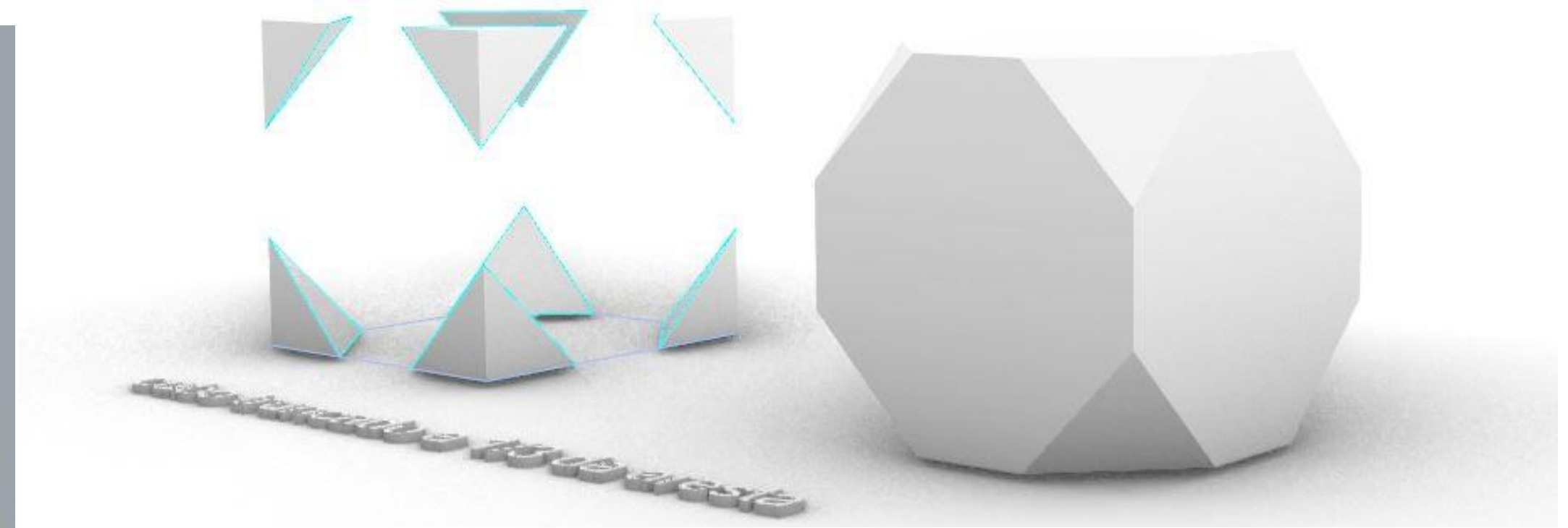
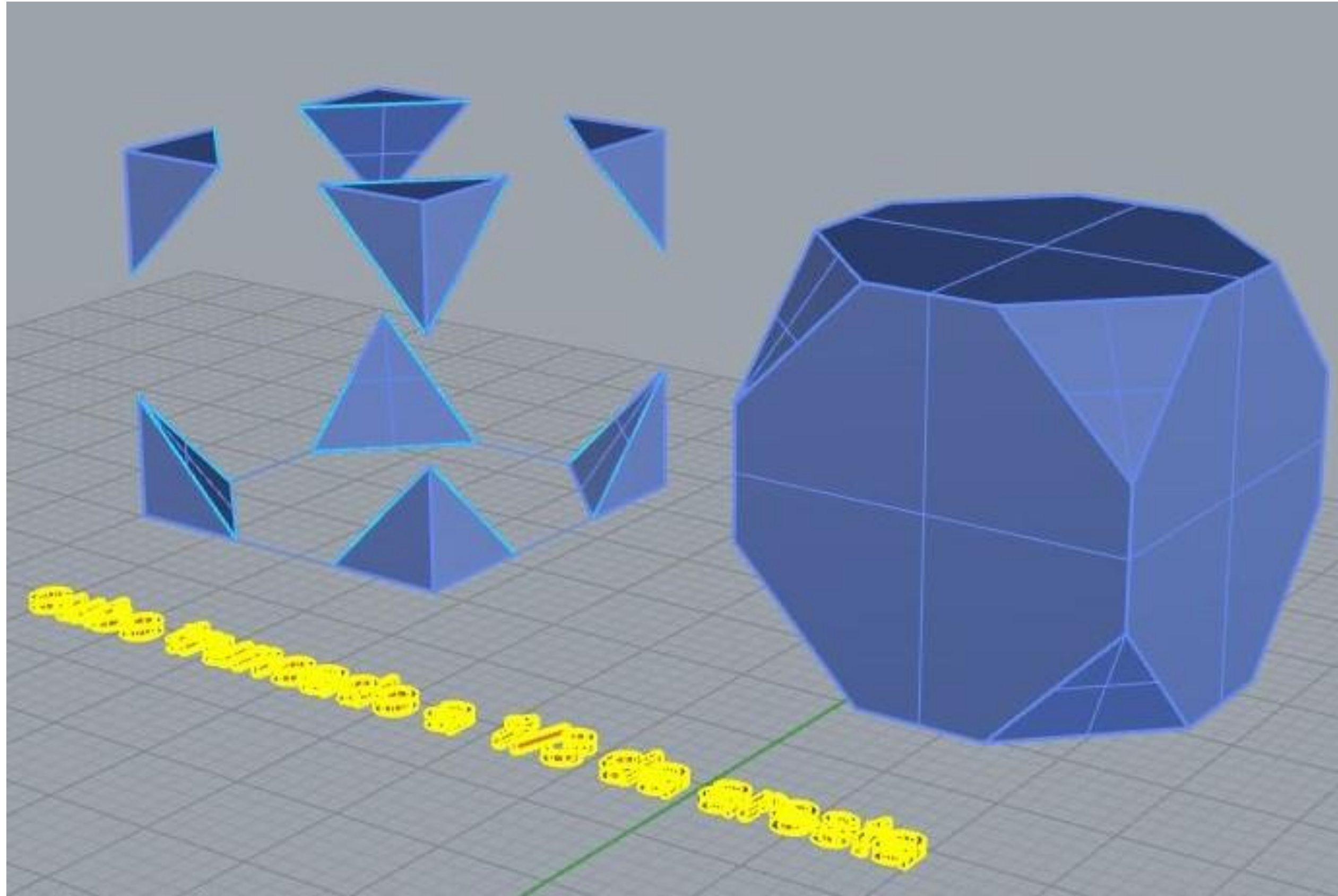

Exerc. 2.1.1 Cubo truncado

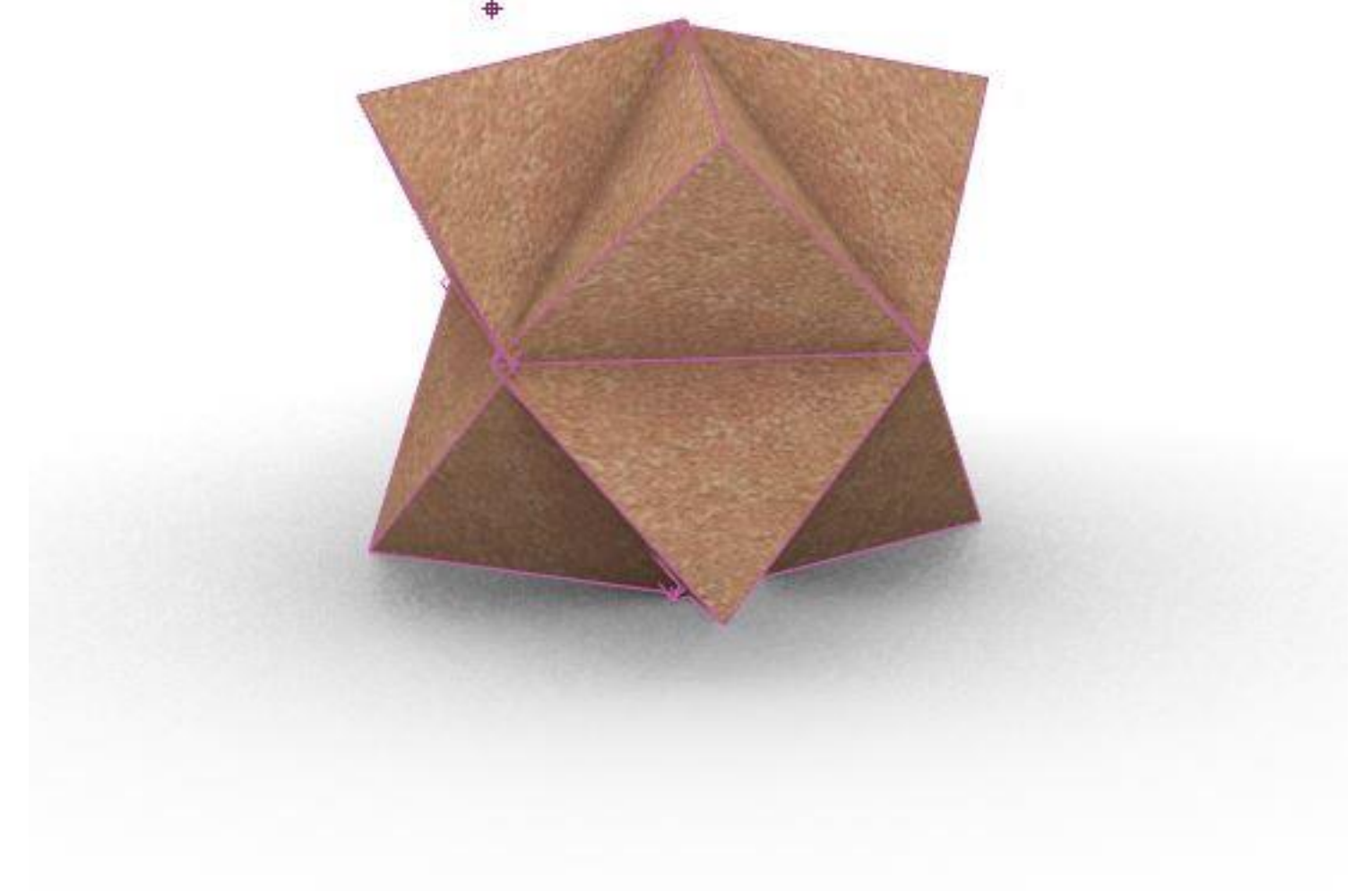
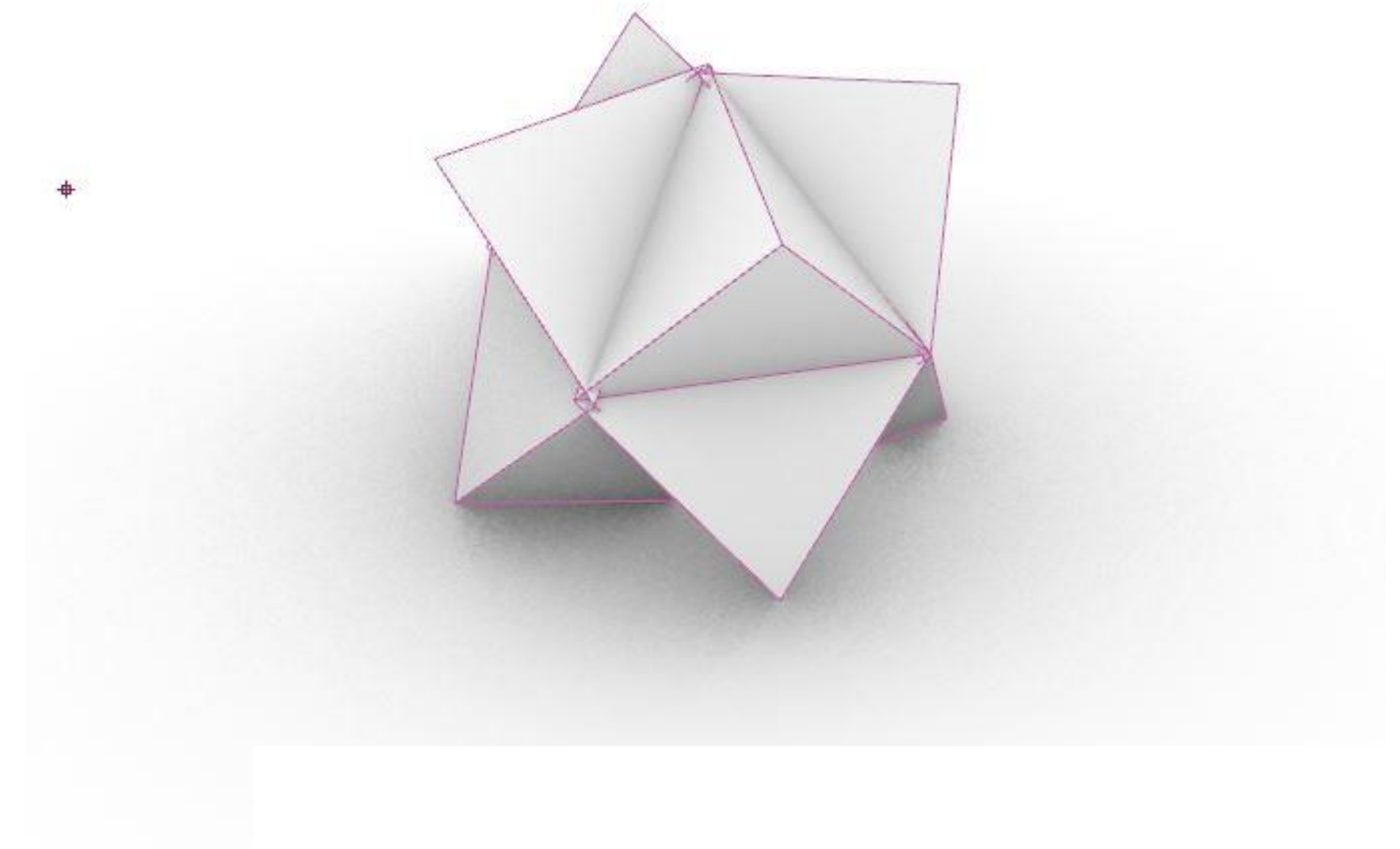
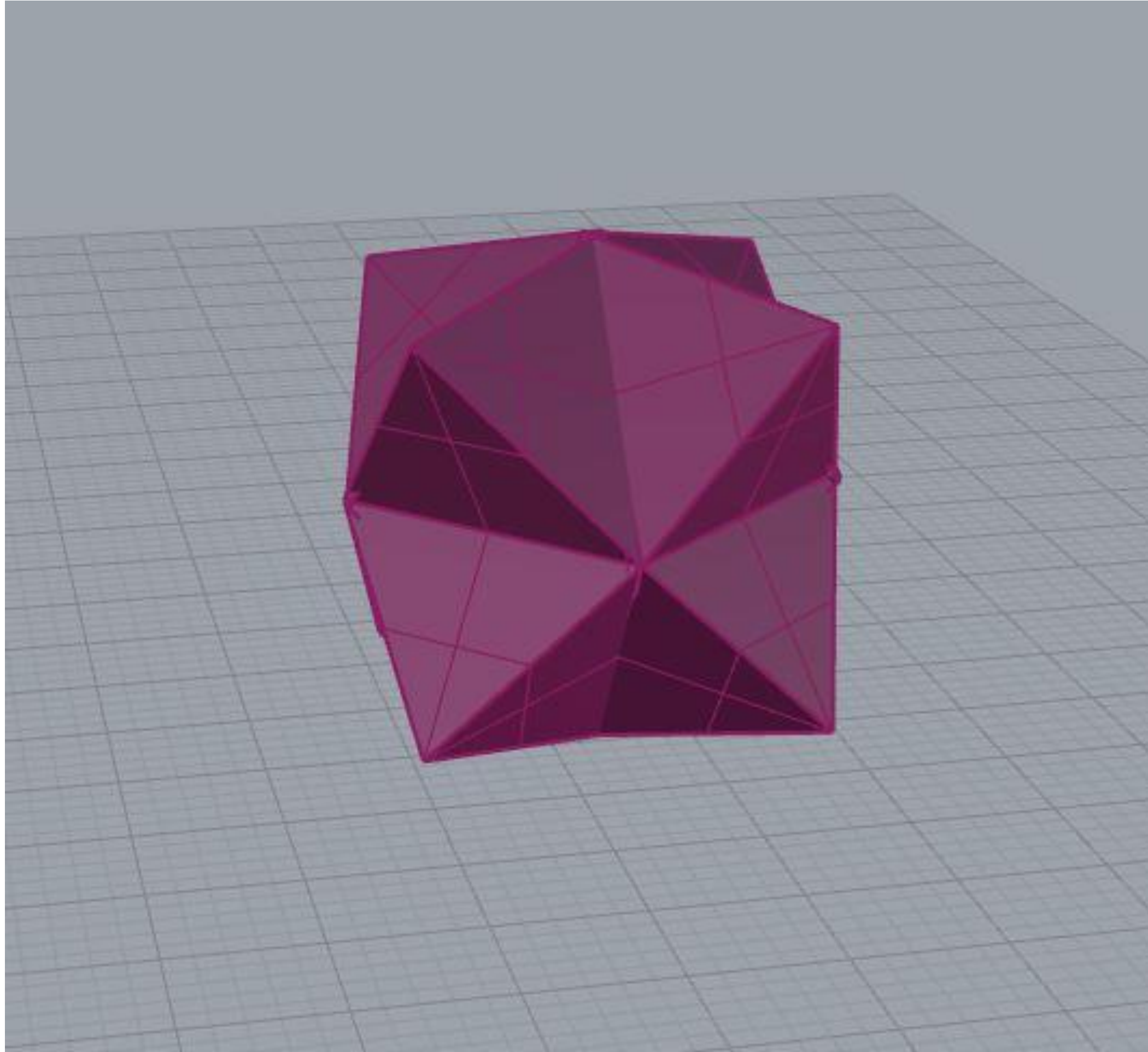

Exerc.2.1.2- Dual cubo



Exerc. 3.1 - Spirula

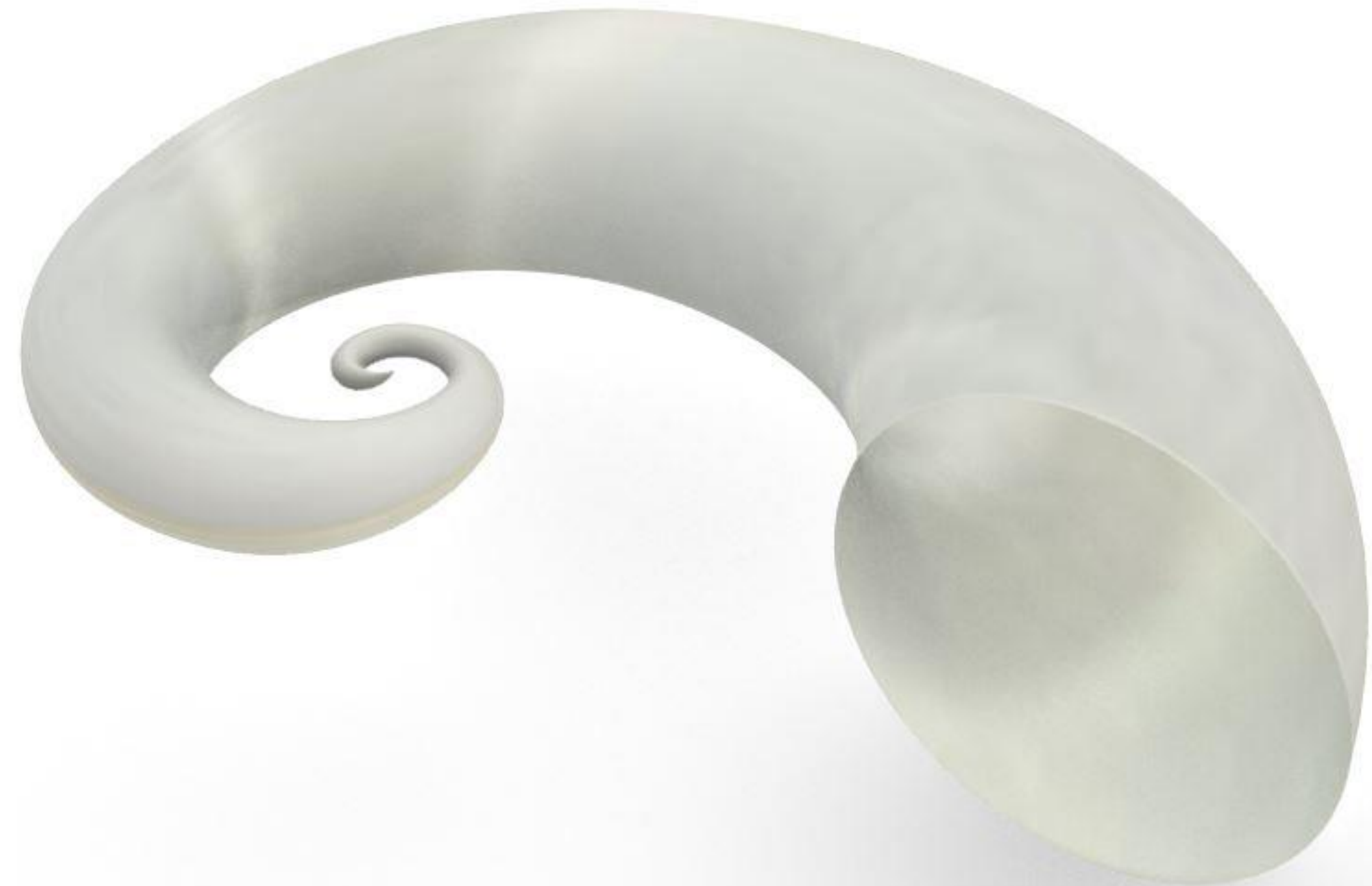
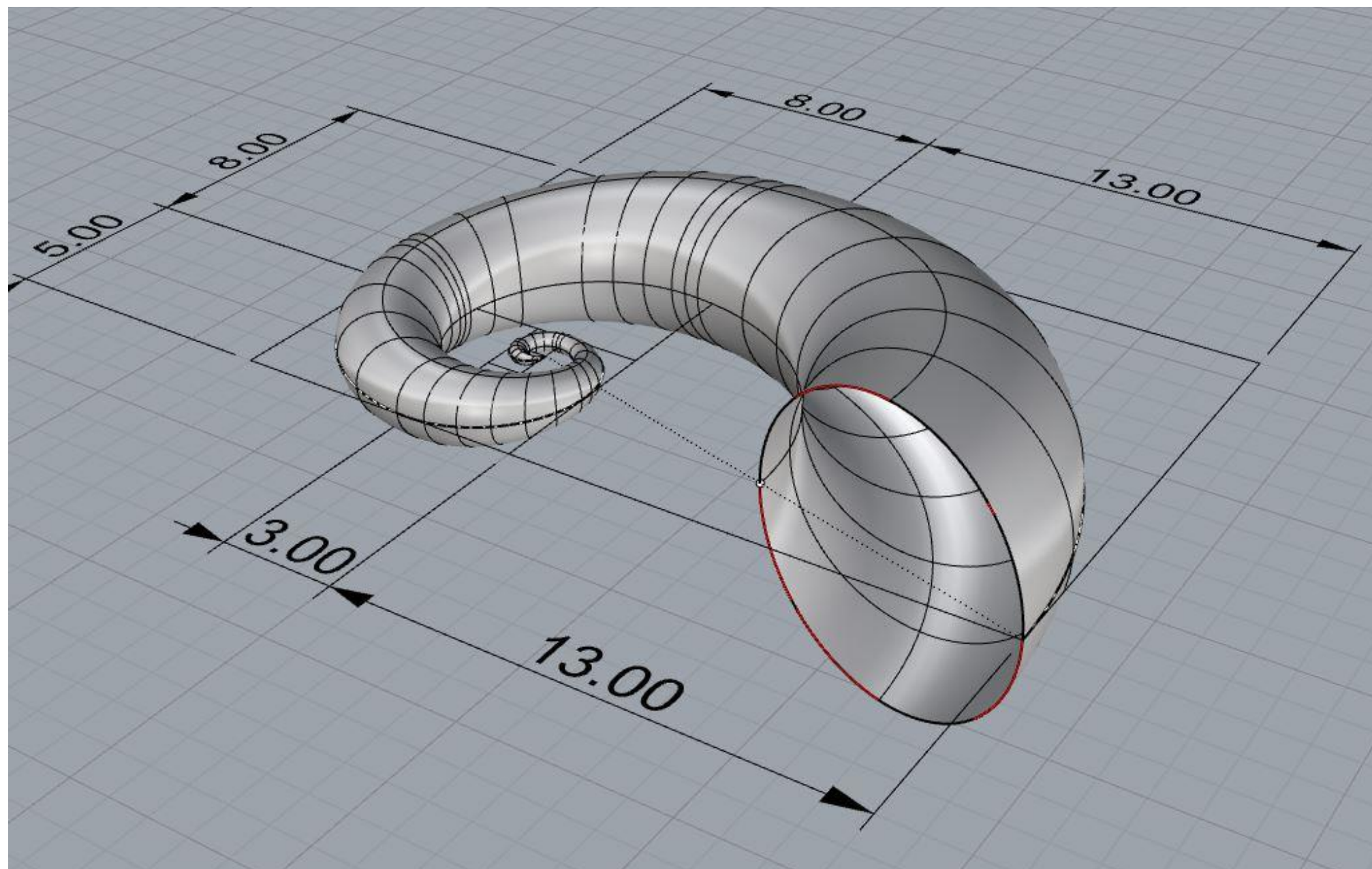
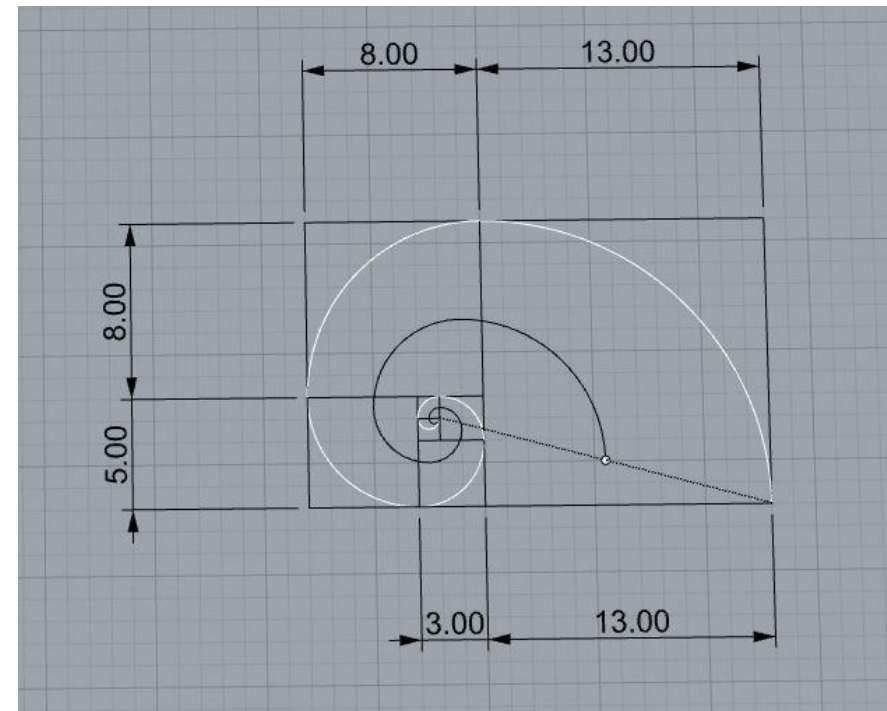
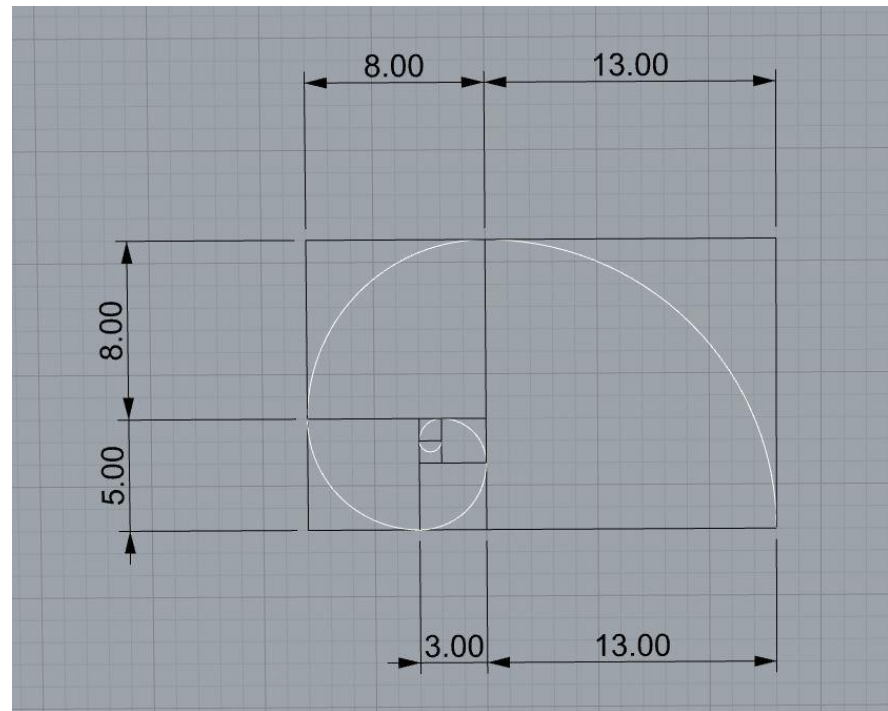

Exerc. 3.1 - Spirula



Exerc. 3.2 - Planorbis

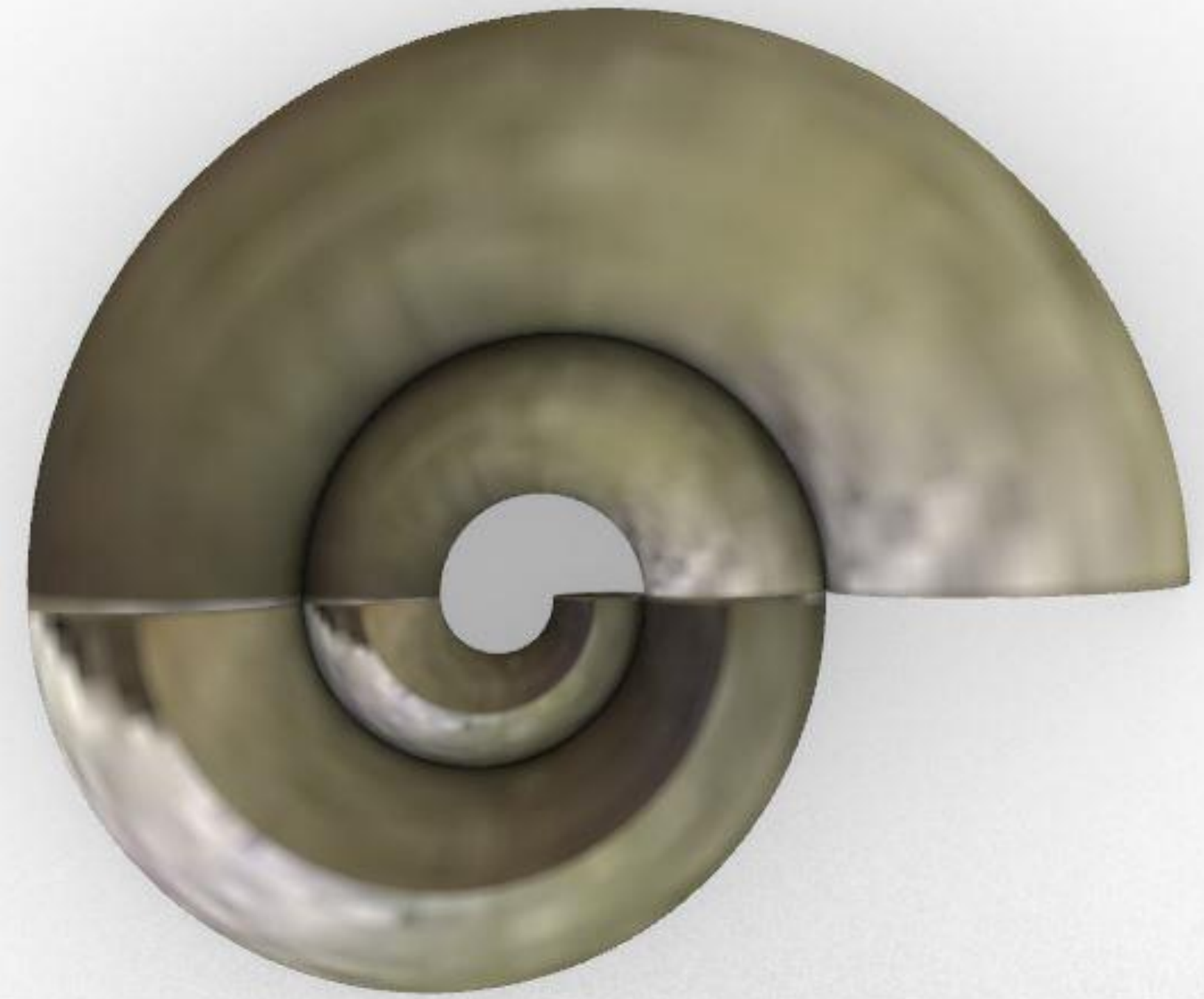
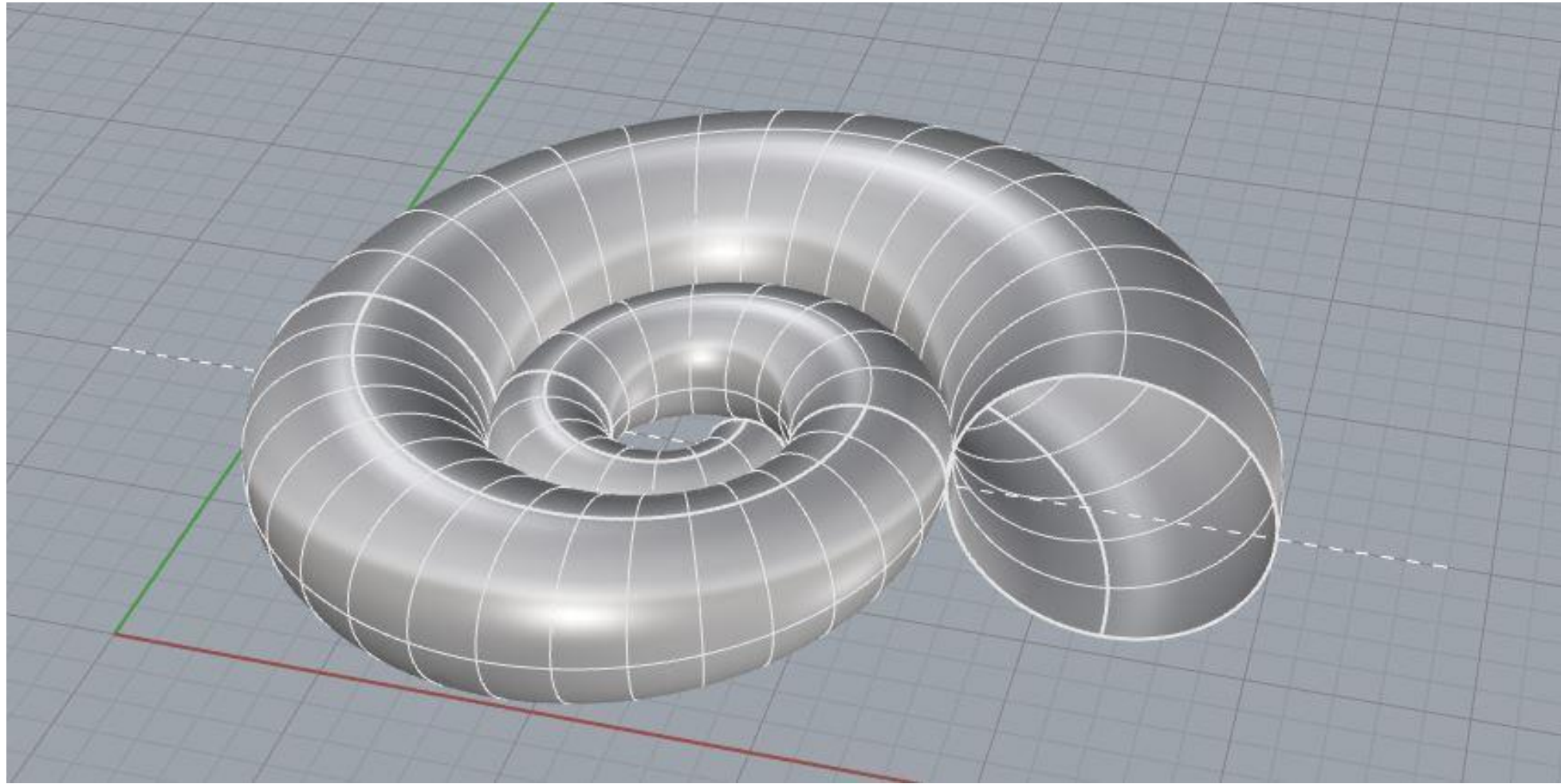

Ex. 2.2 - Planorbis

Exerc. 3.2 - Planorbis



Exerc. 3.3 - Nautilus

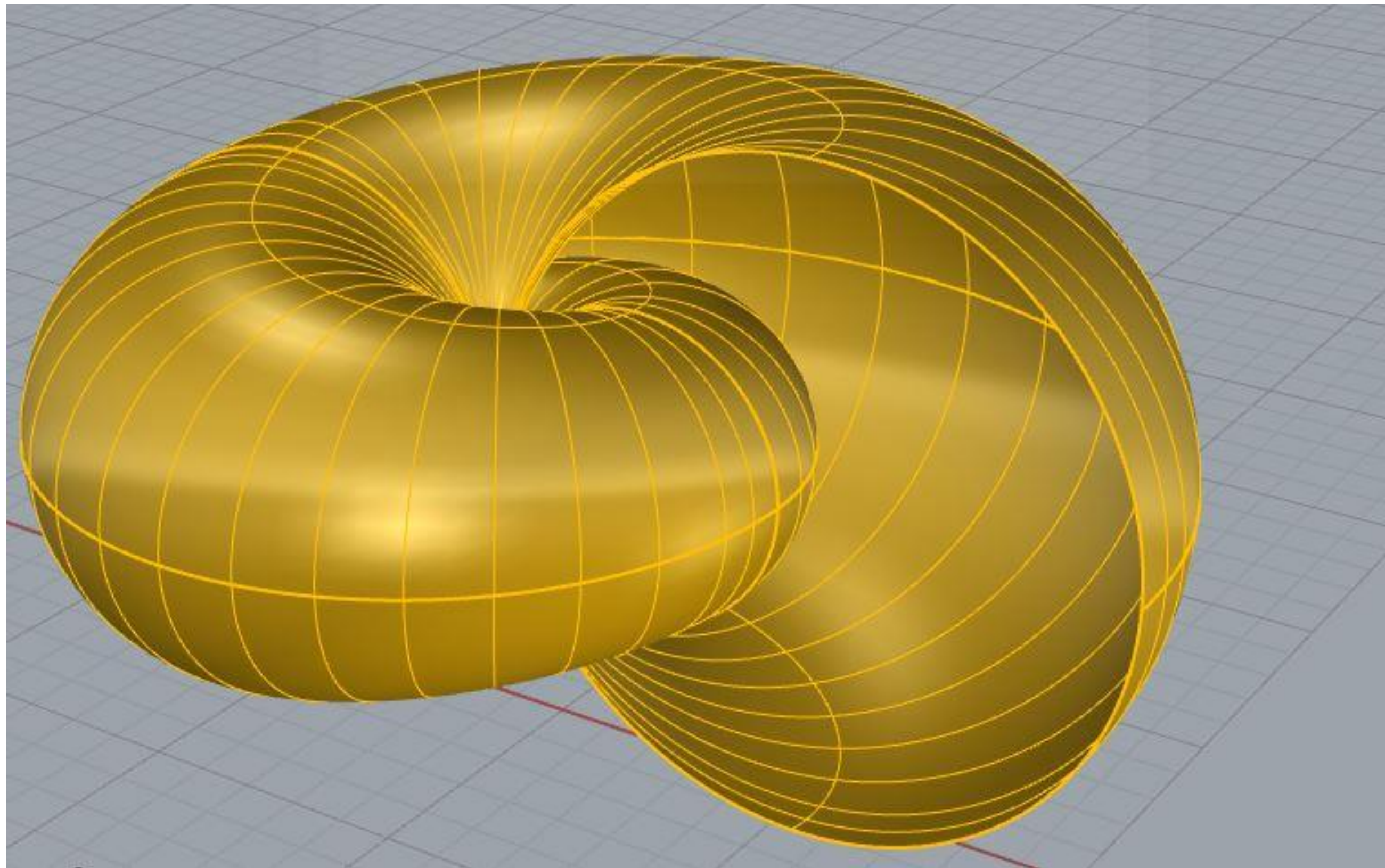

Exerc. 3.3 - Nautilus



Exerc. 3.4 - Caracol

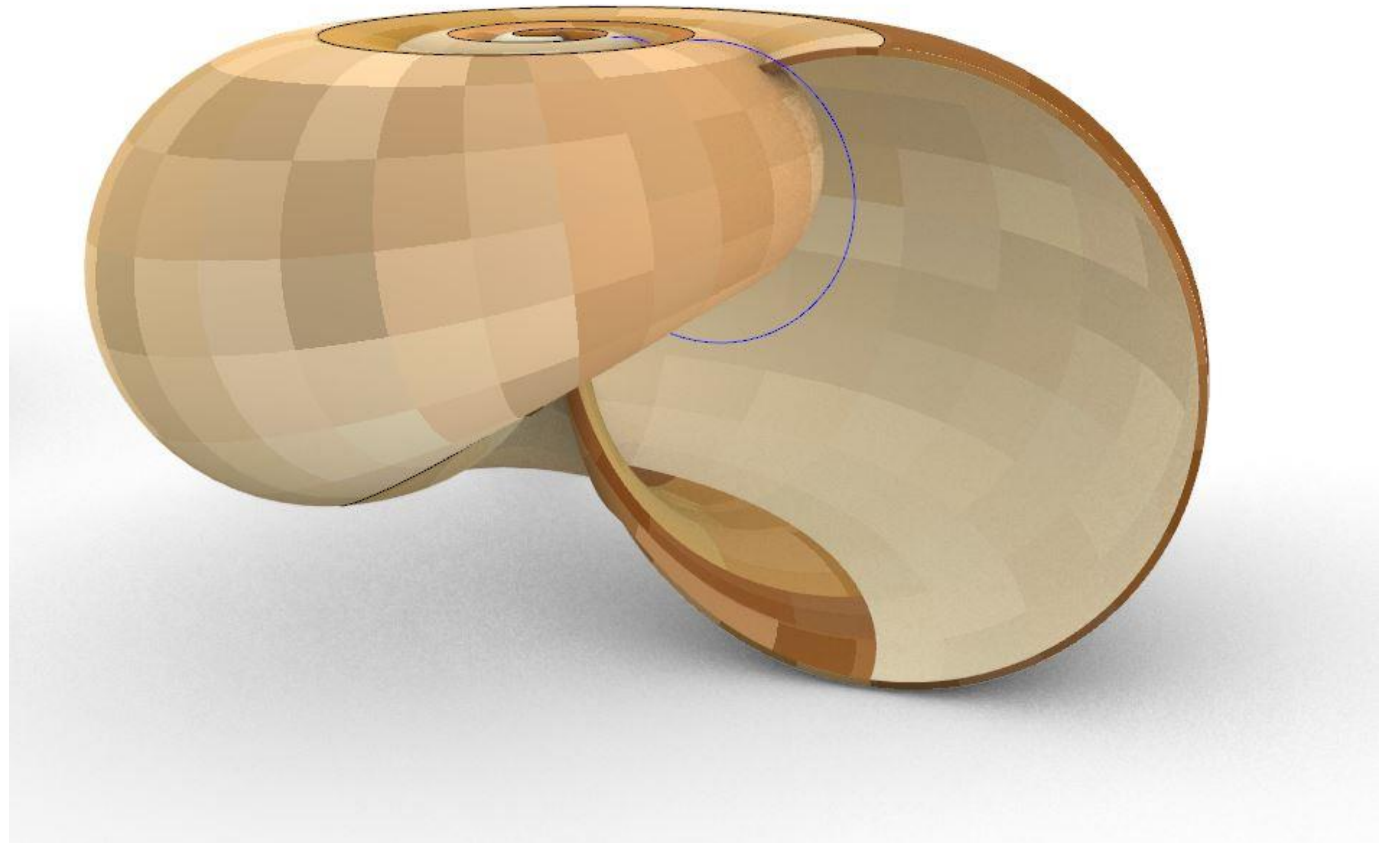
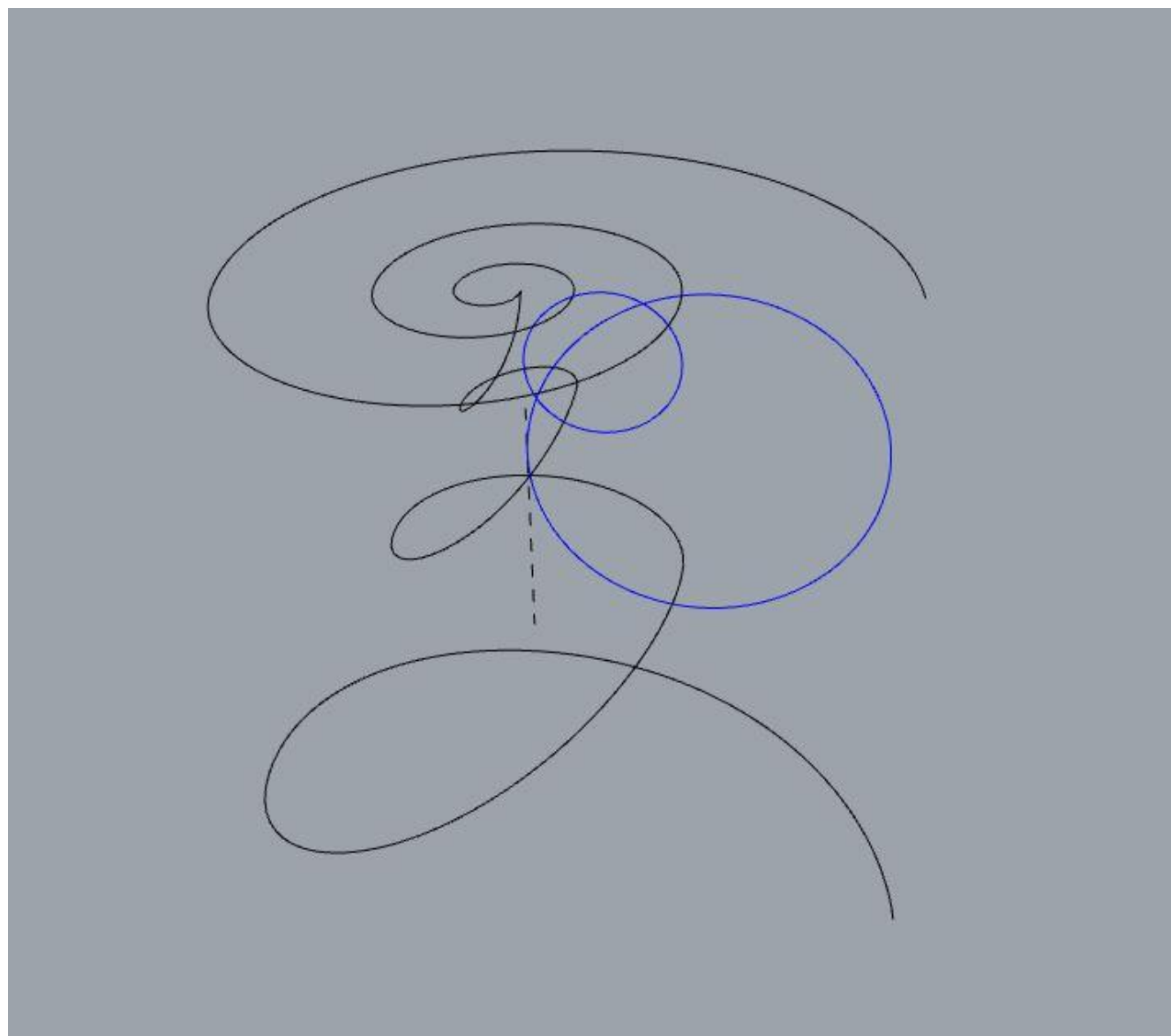
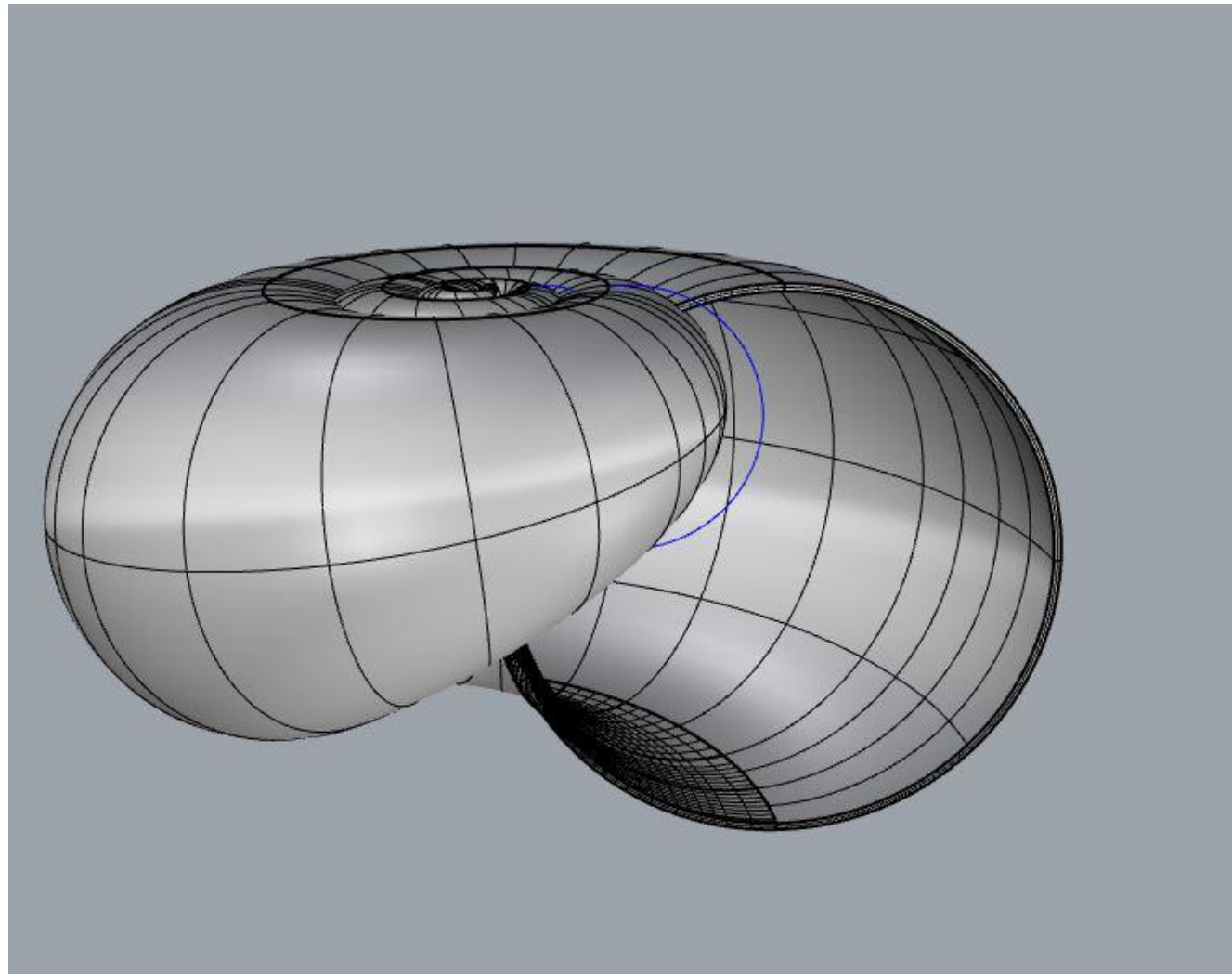

Exerc. 3.4 - Caracol



Exerc.3.5- Caramujo

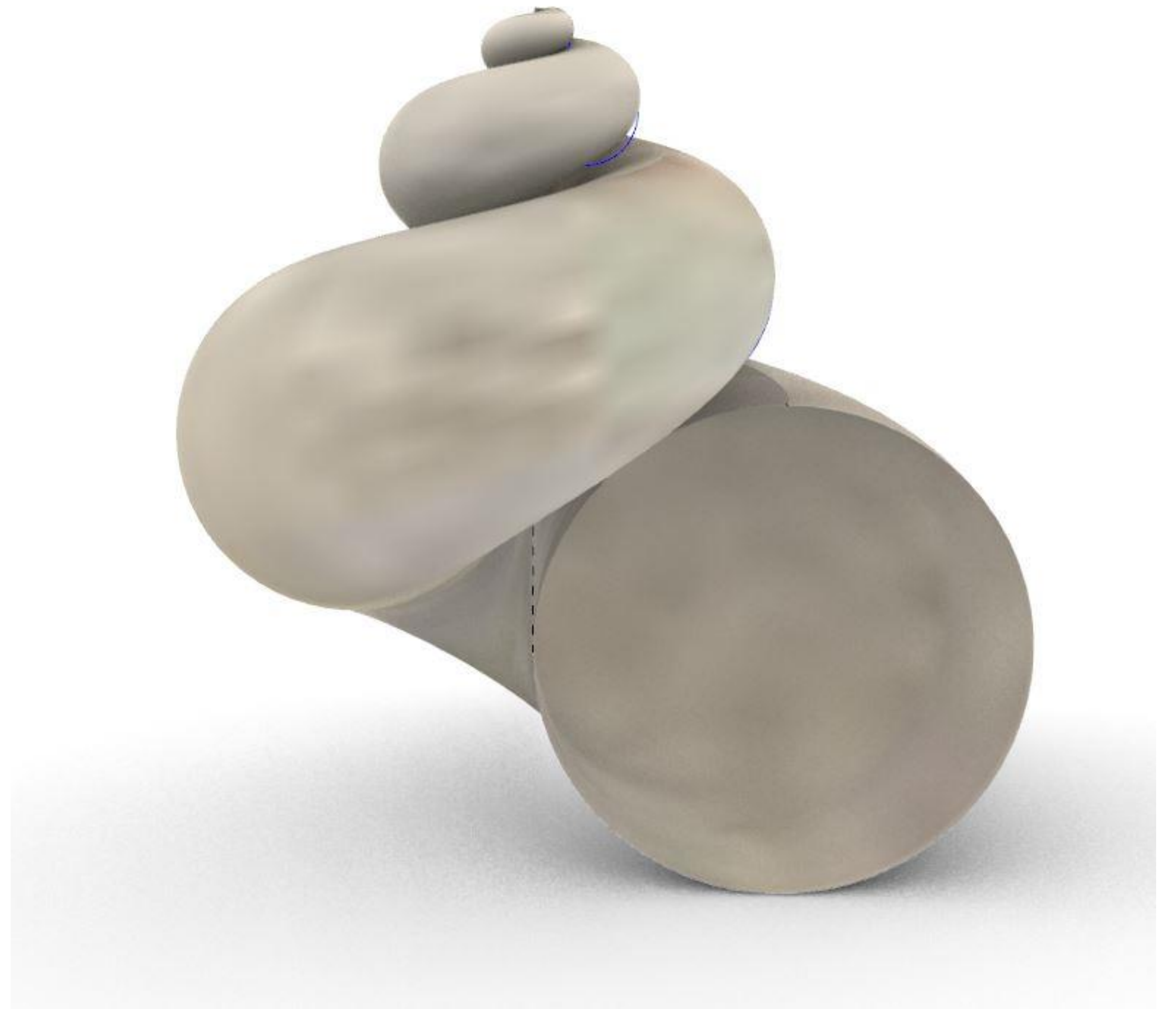
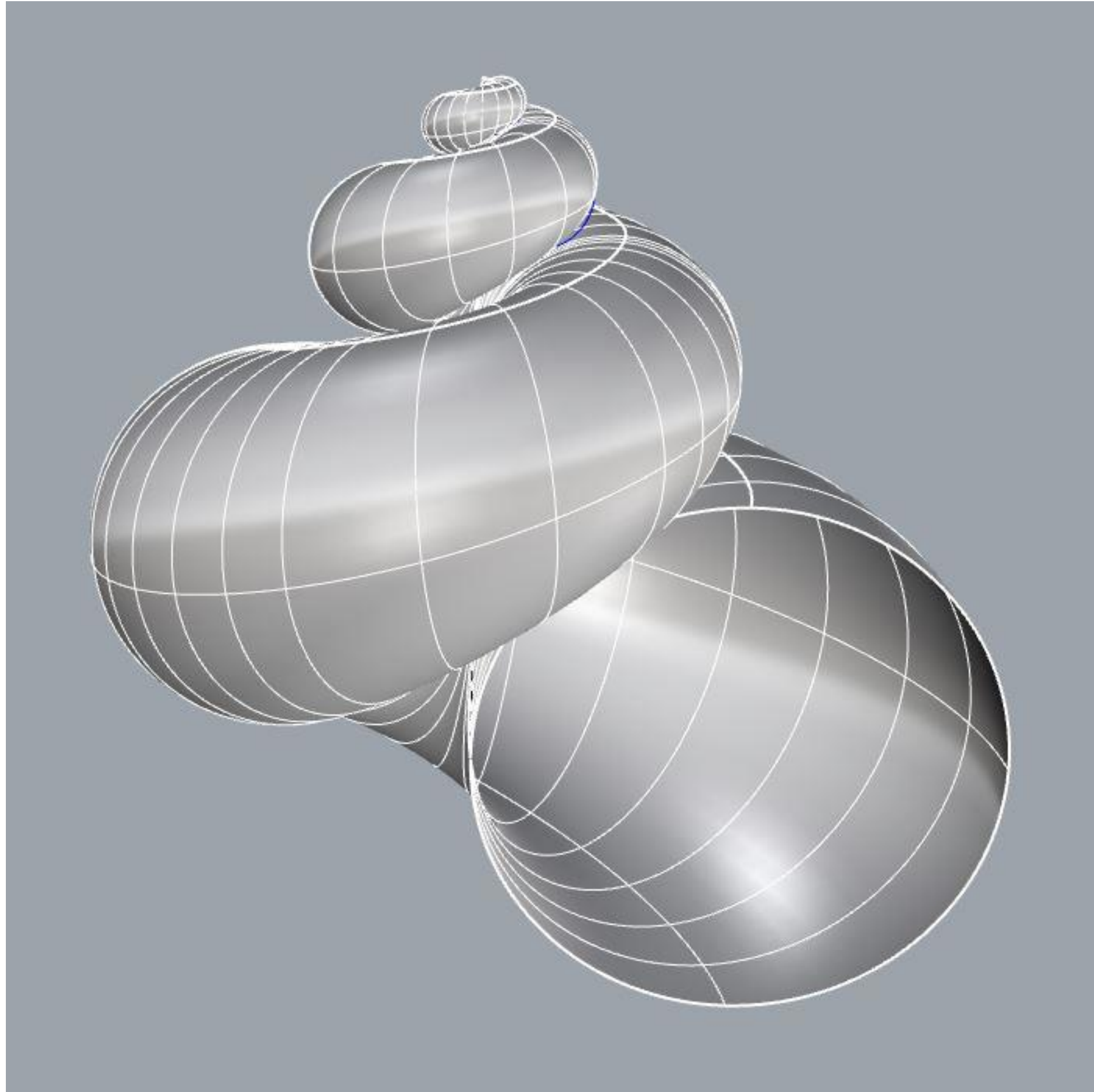

Exerc.3.5-caramujo

Exerc.4 - grasshopper

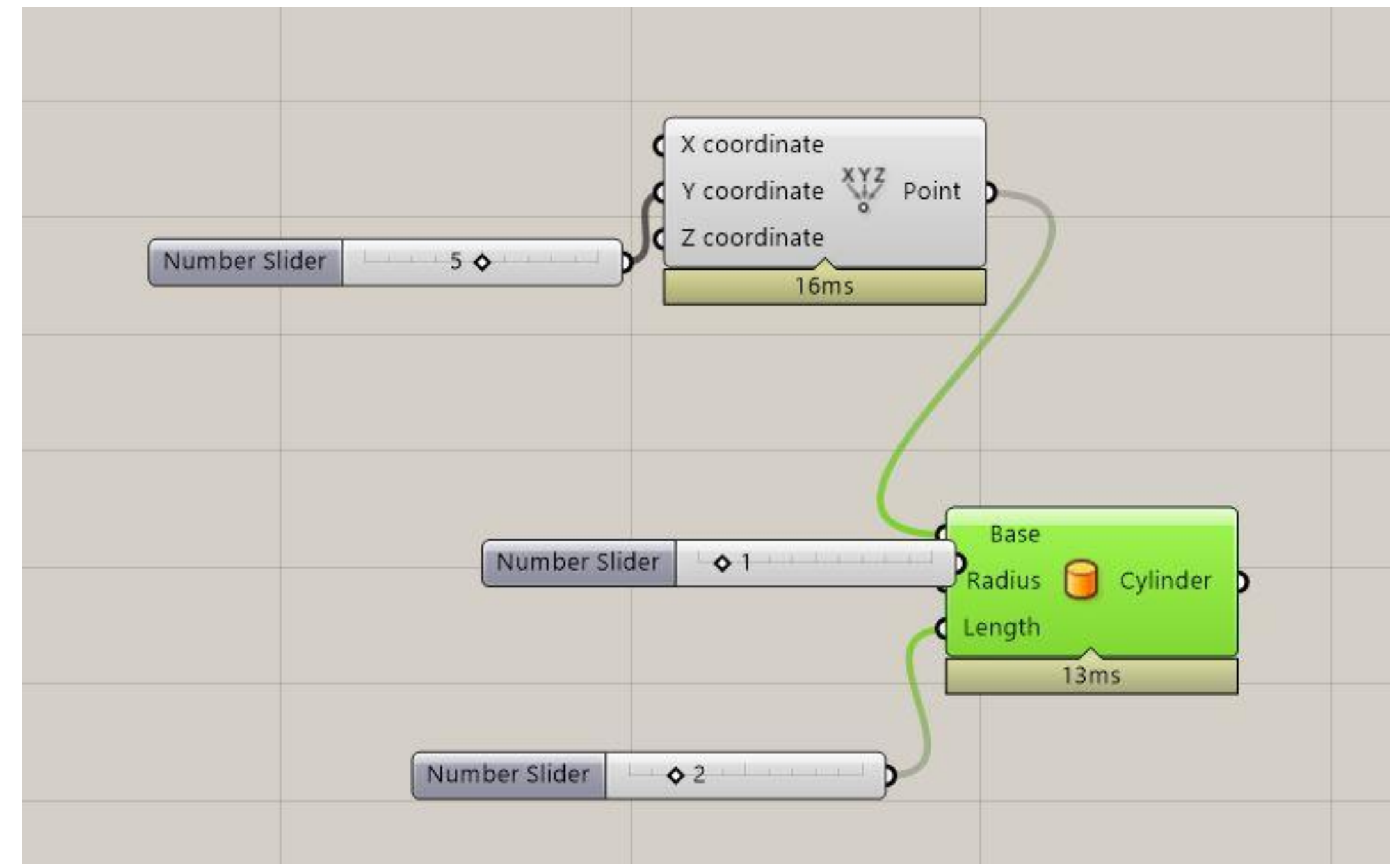
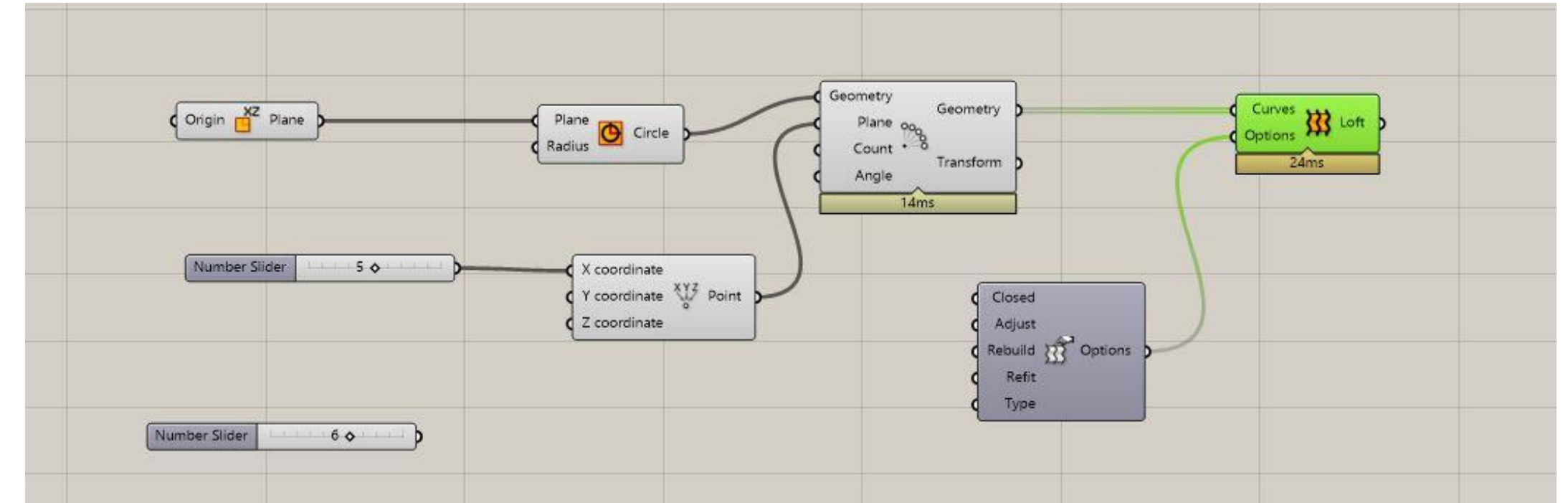
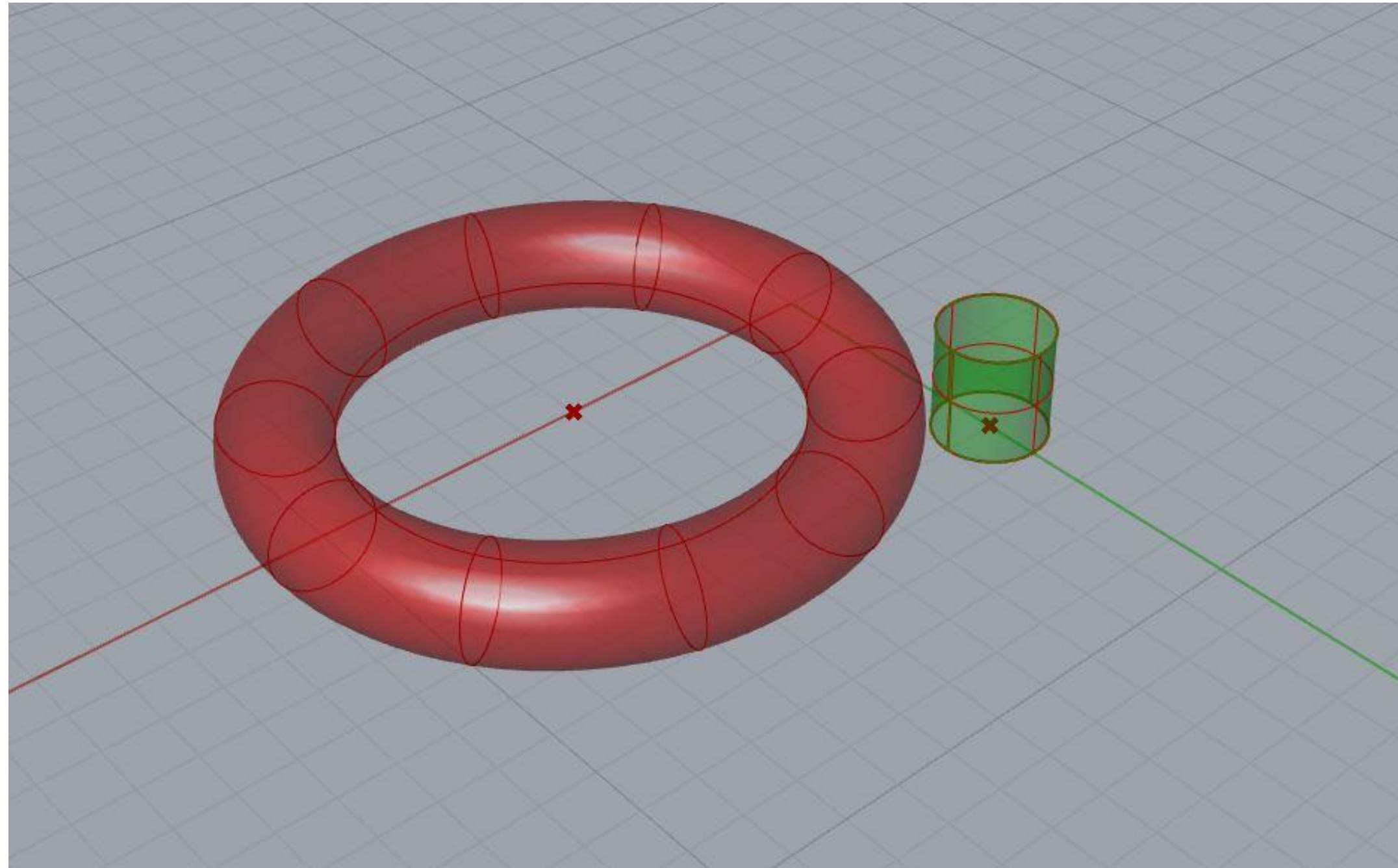

Exerc. 4.1- Formas geométricas

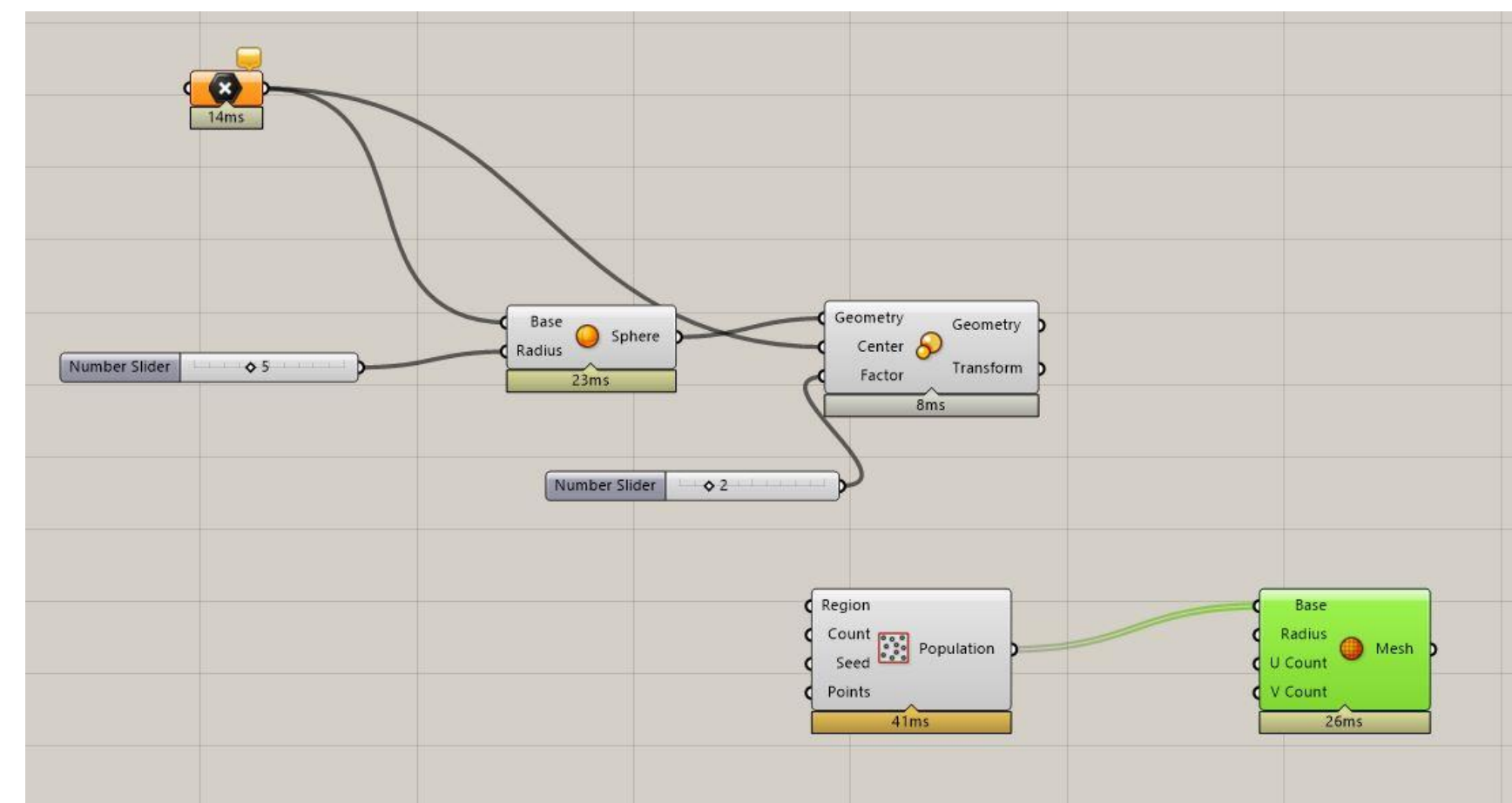
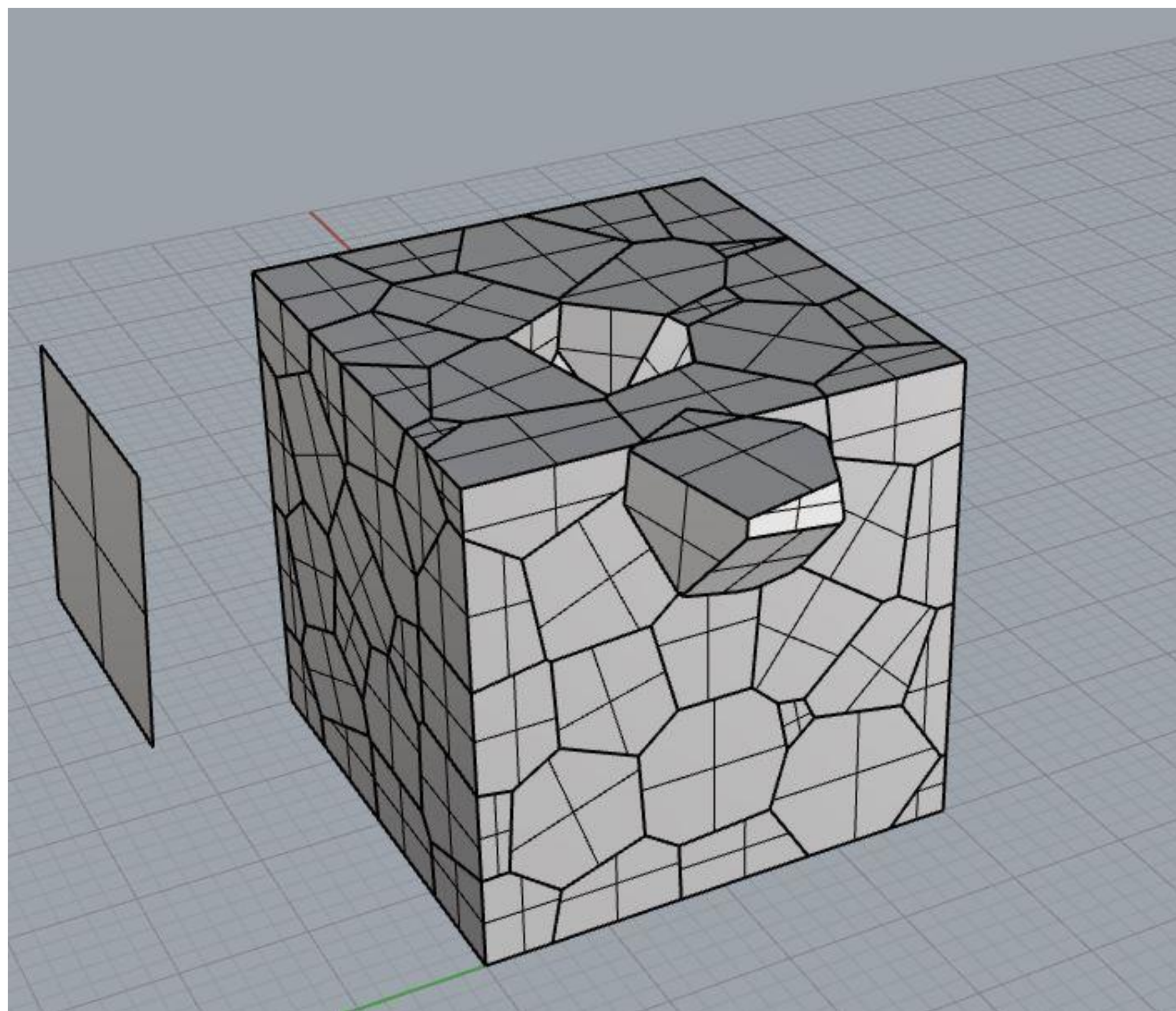

Exerc. 4.2 - Formas geométricas

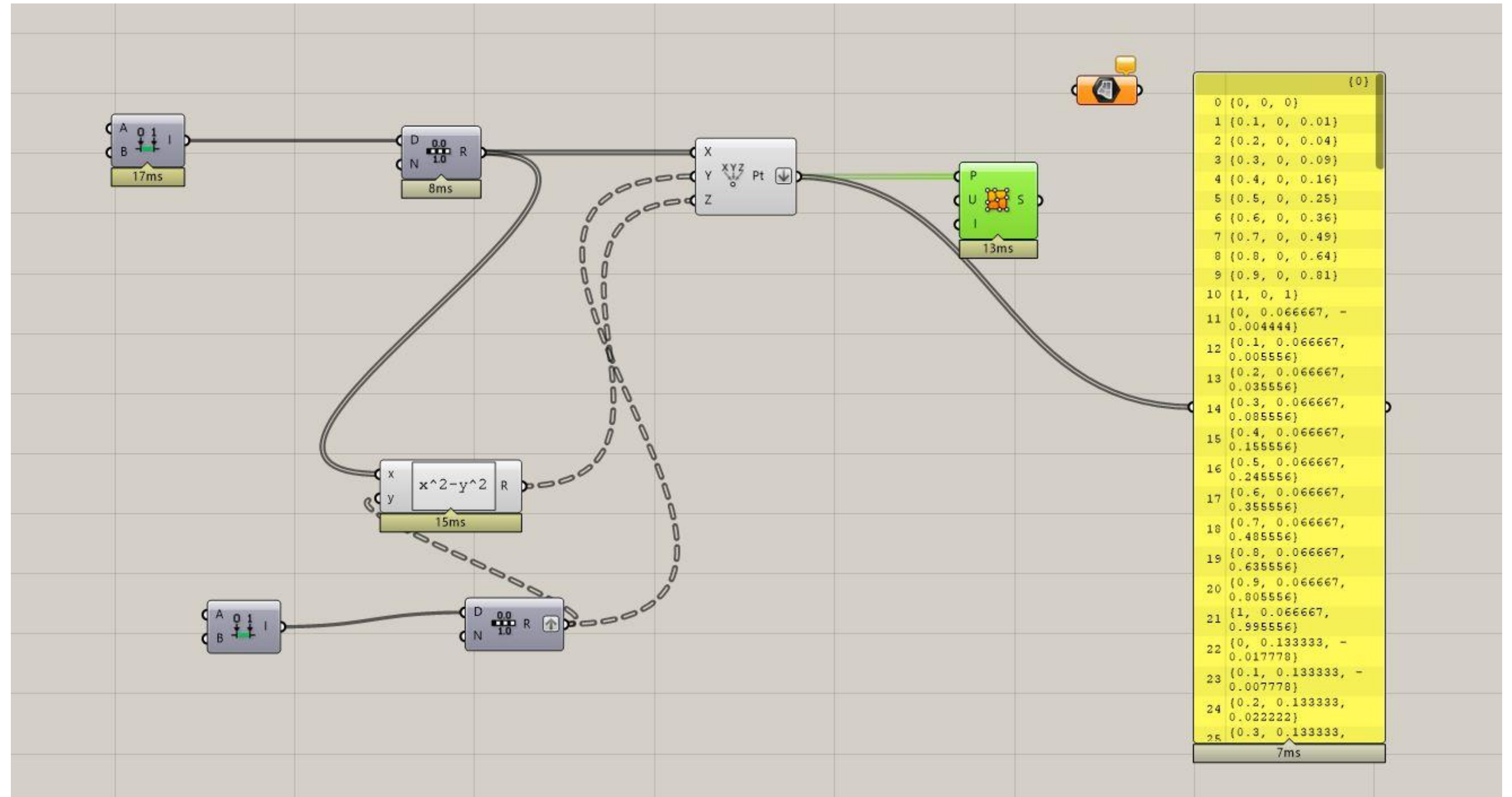
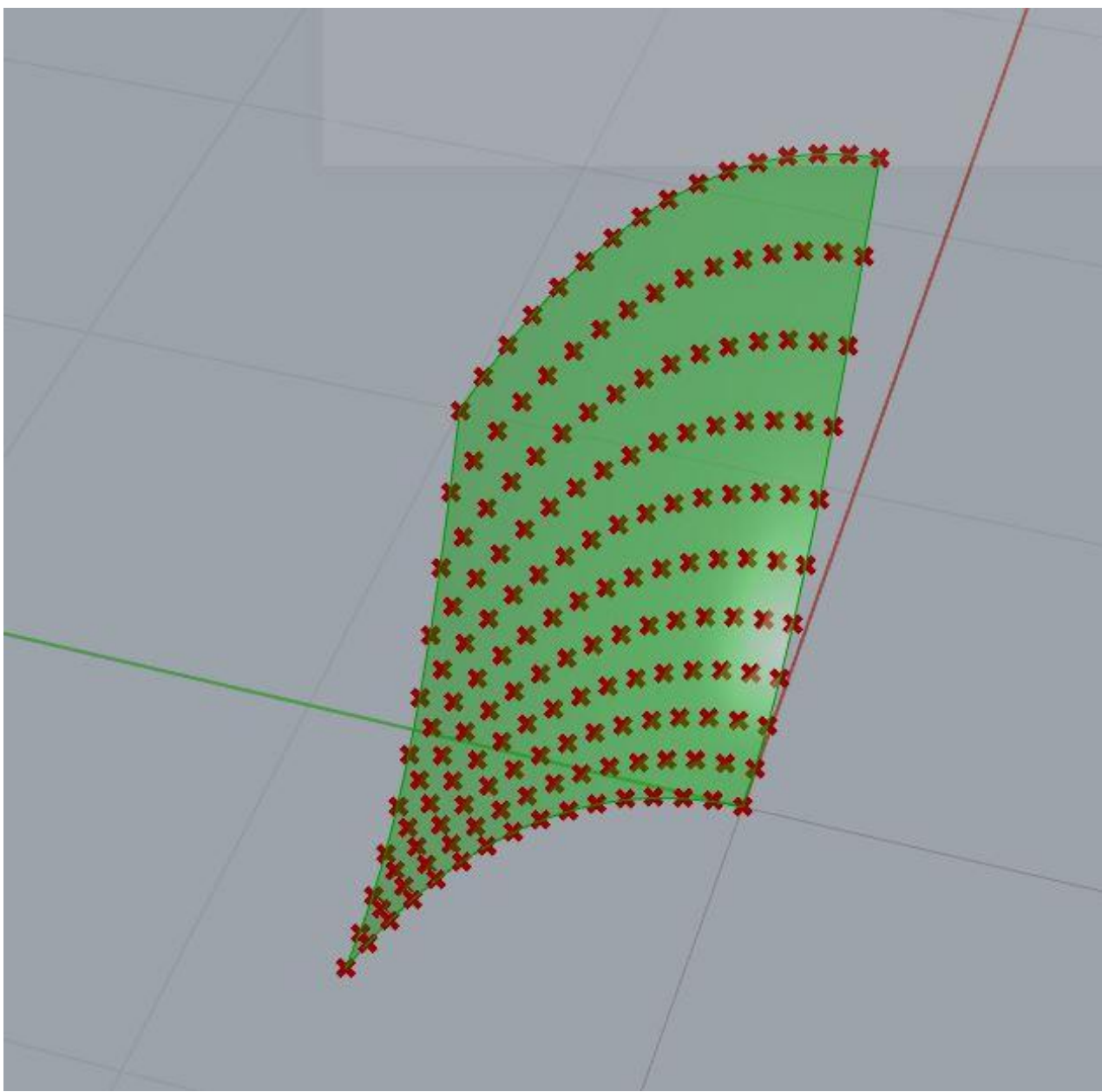

Exerc. 4.3 – Plano curvo

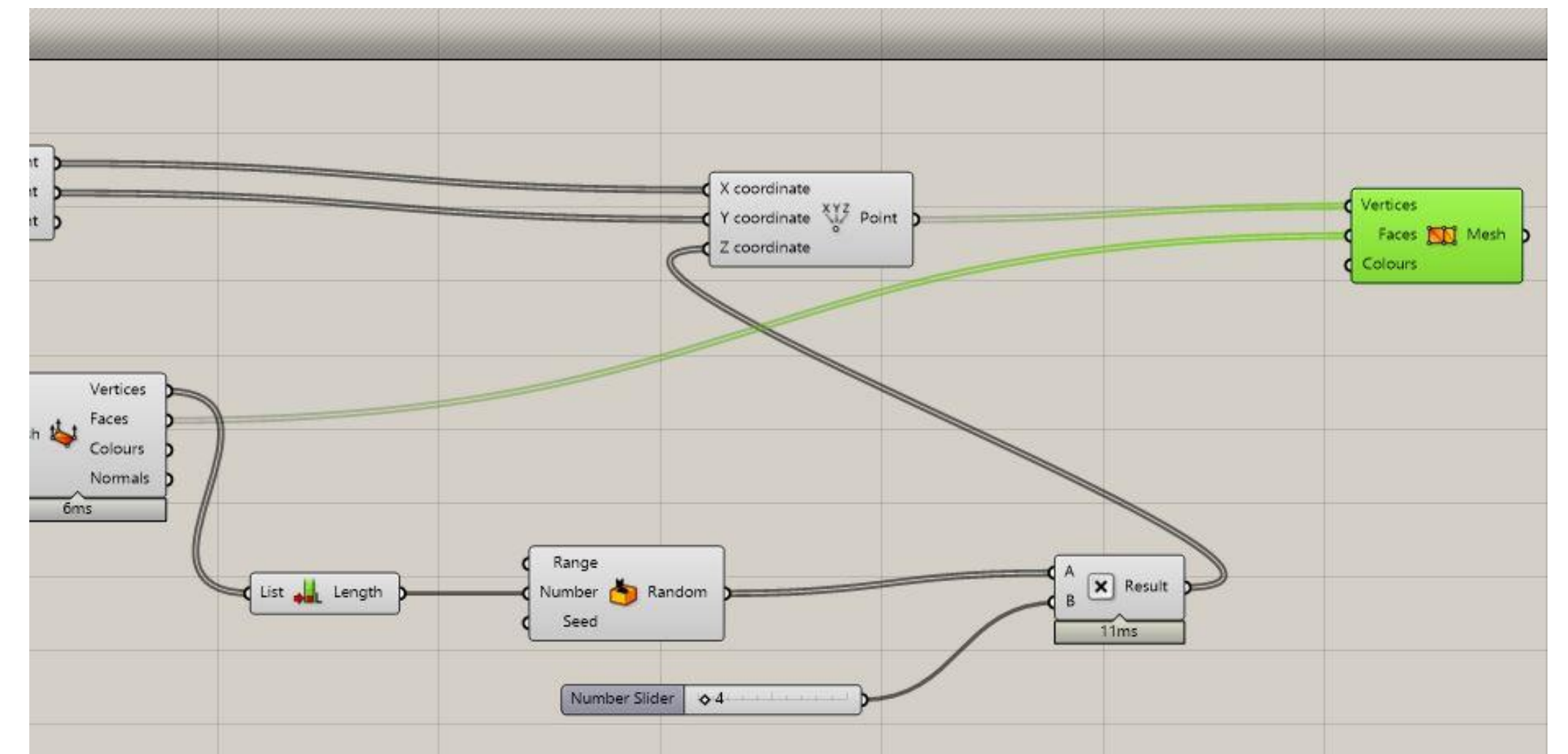
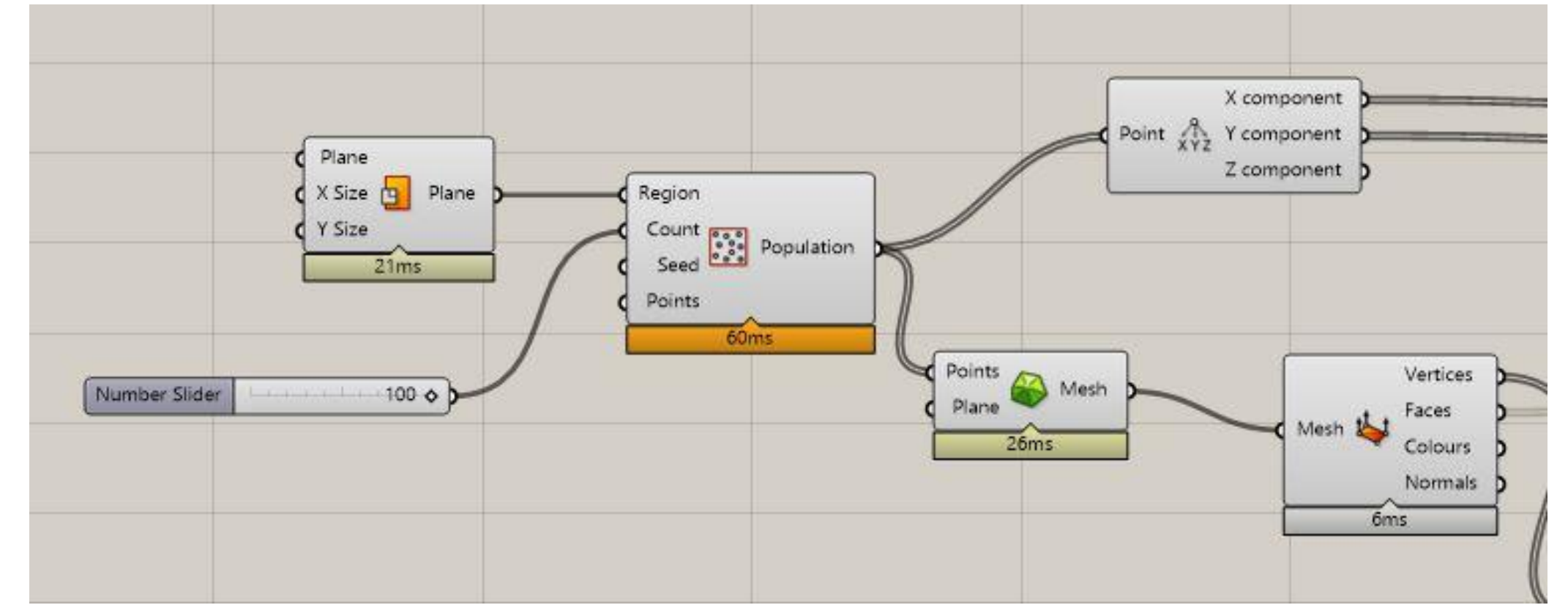
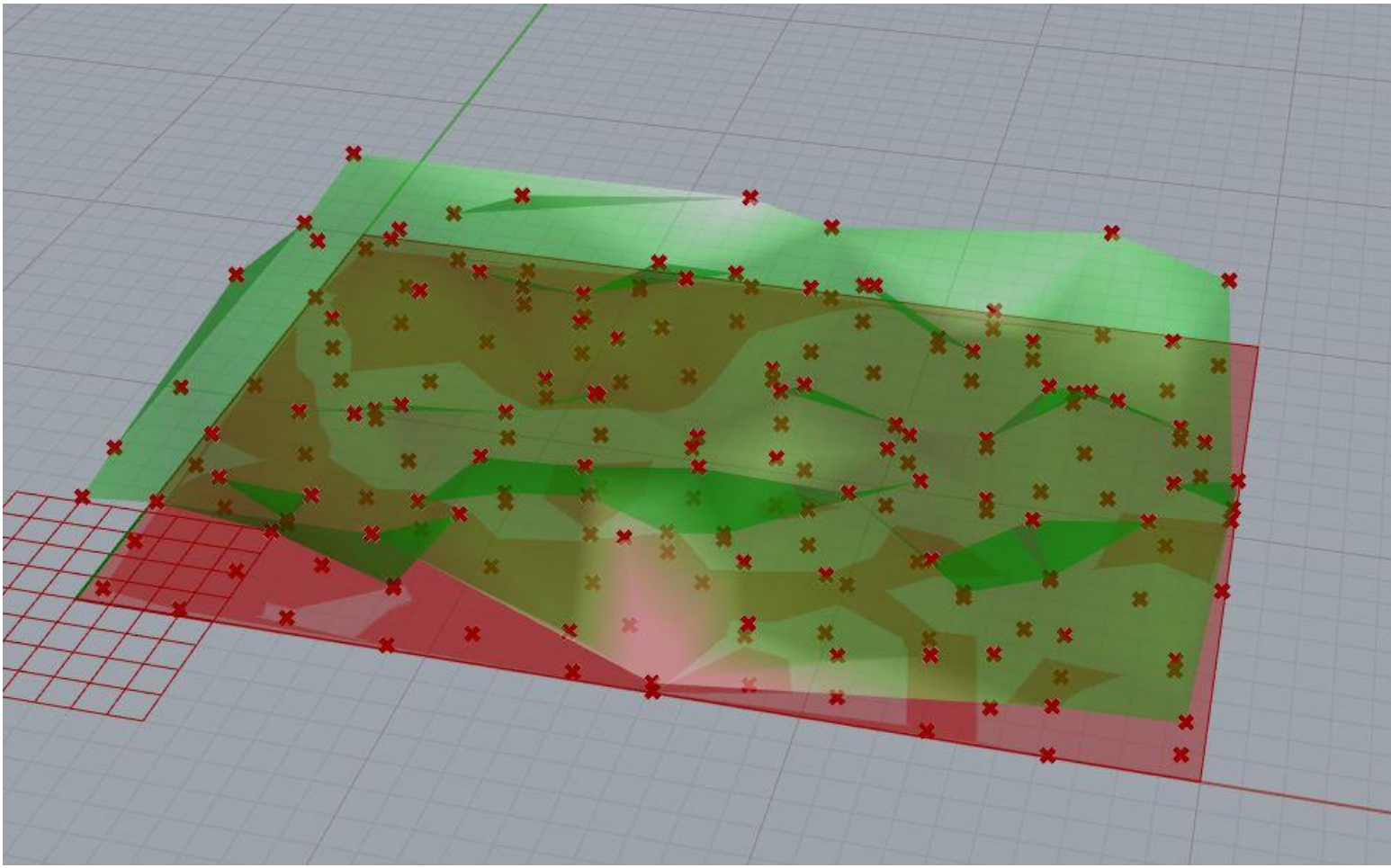

Exerc. 4.4 – terreno hipotético

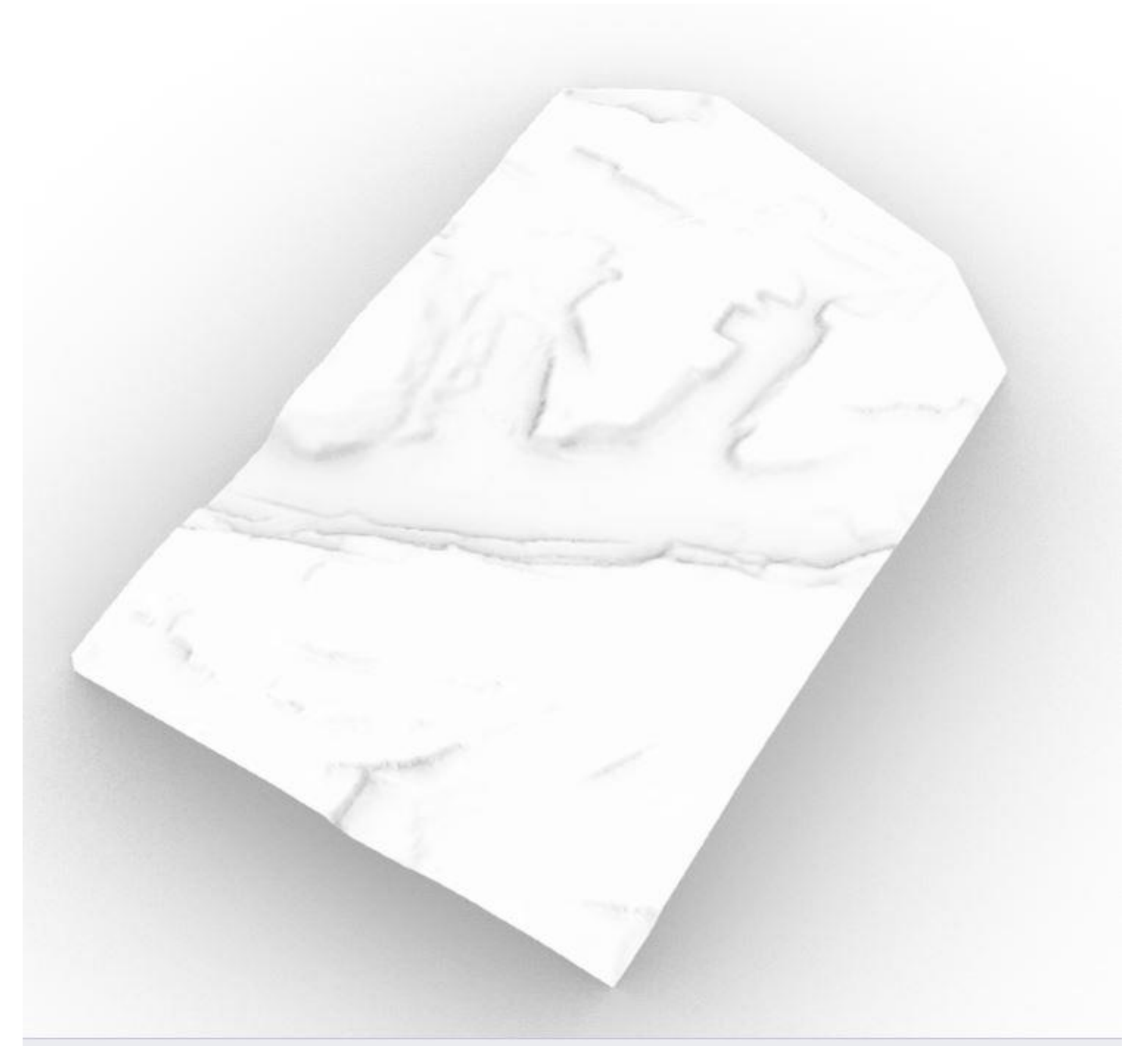
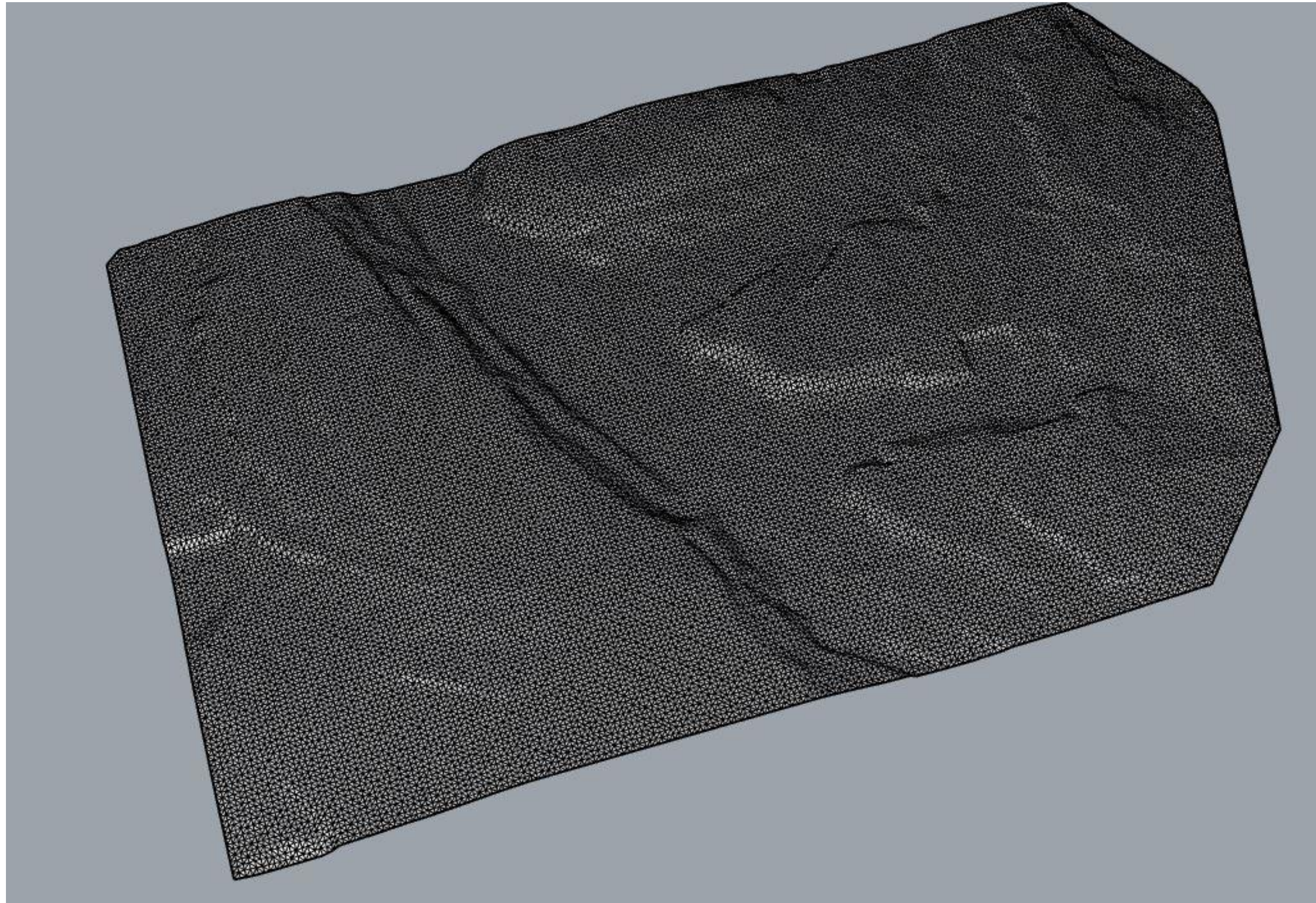

Exerc. 4.5 – terreno do projeto



Exerc. 5.1 - Mexilhão

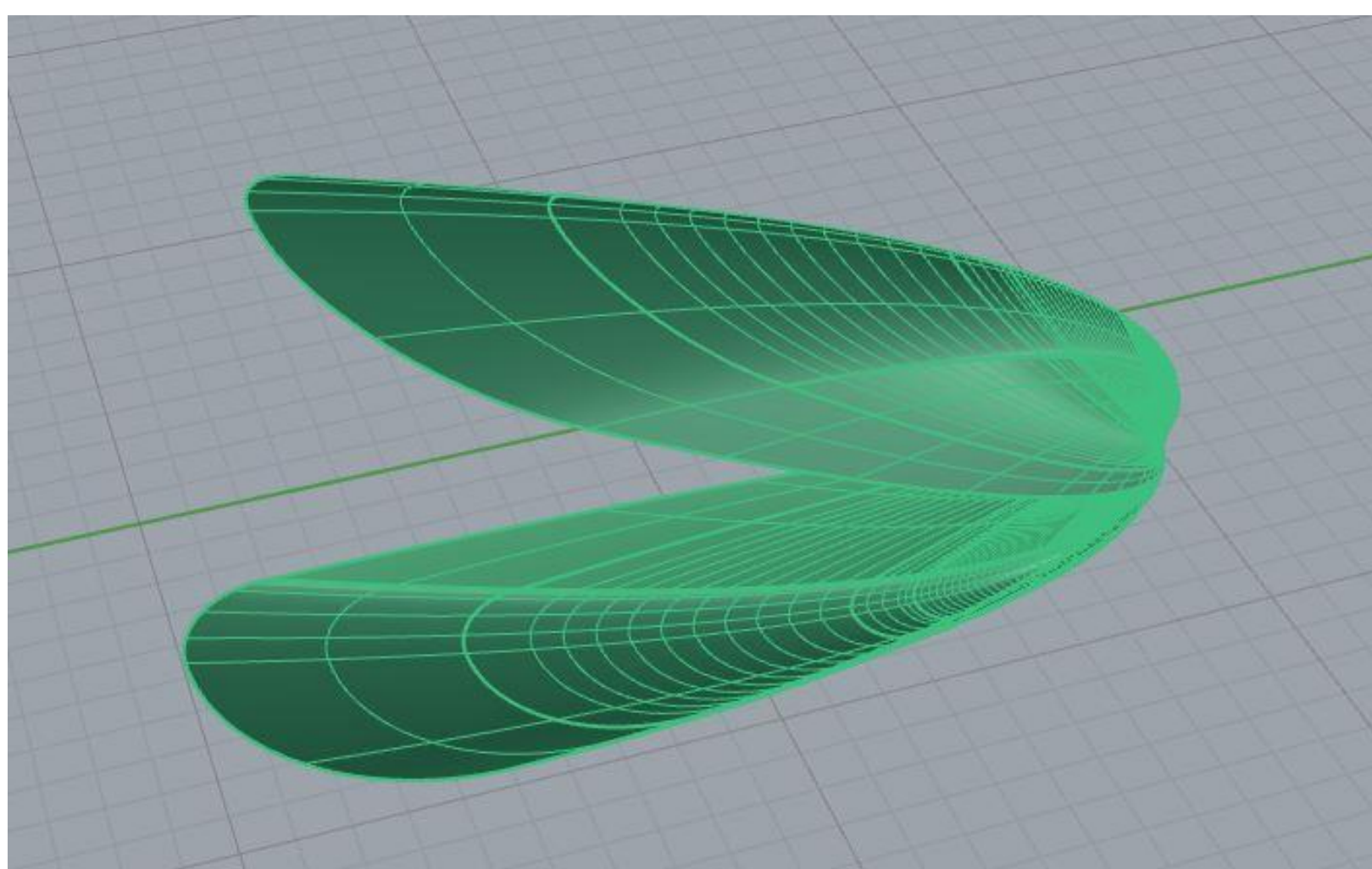
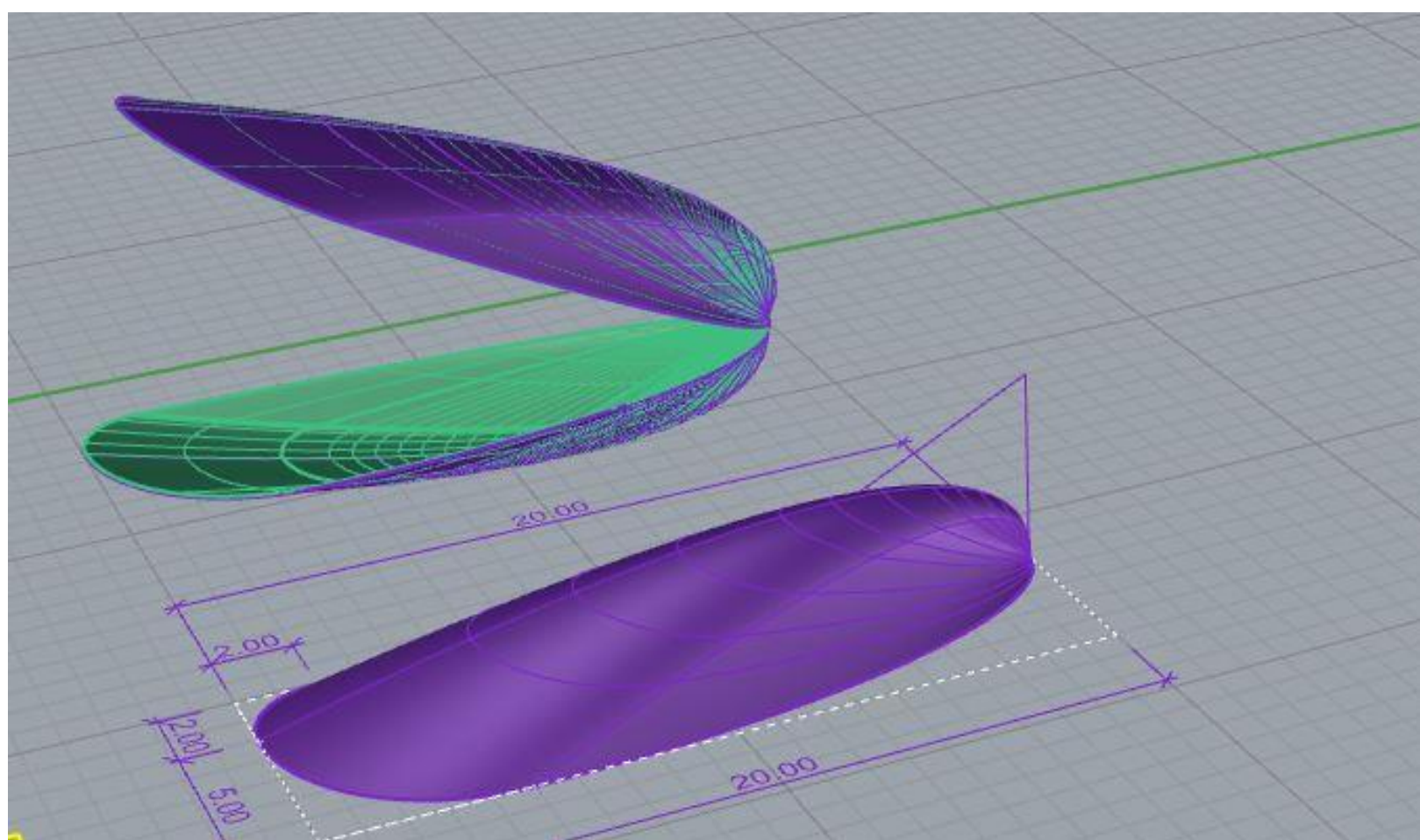

Exerc. 5.1 - Mexilhão



Exerc. 5.2 - Ameijoa

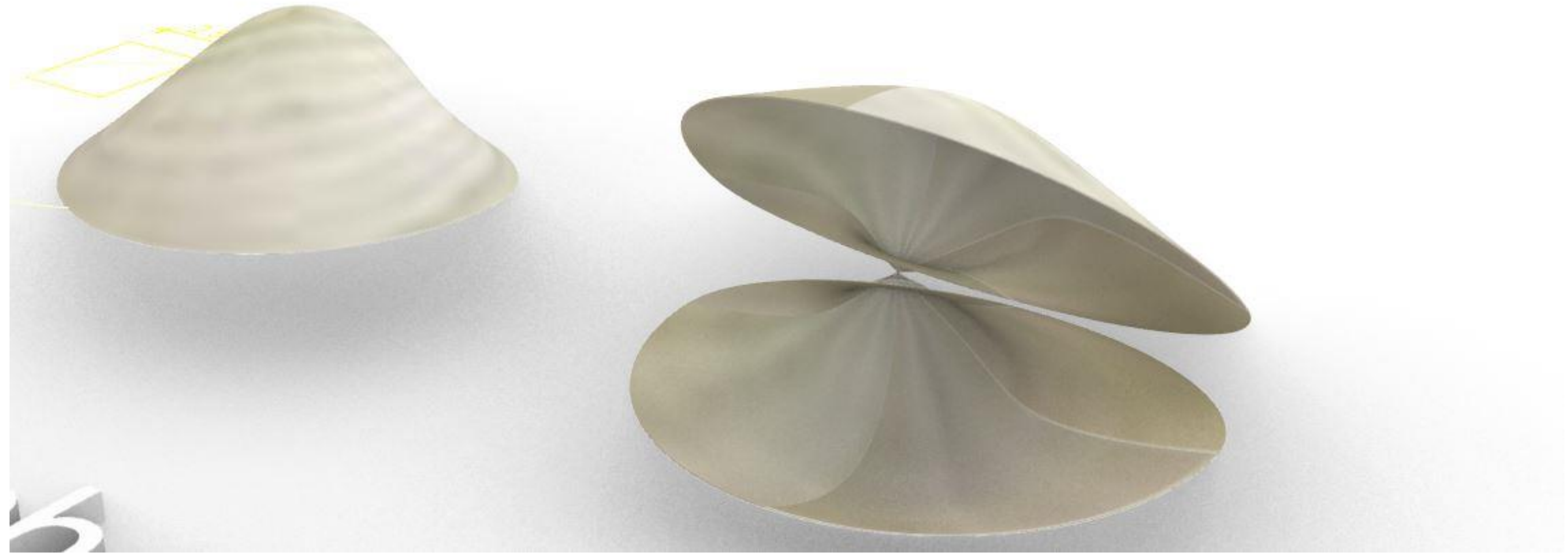
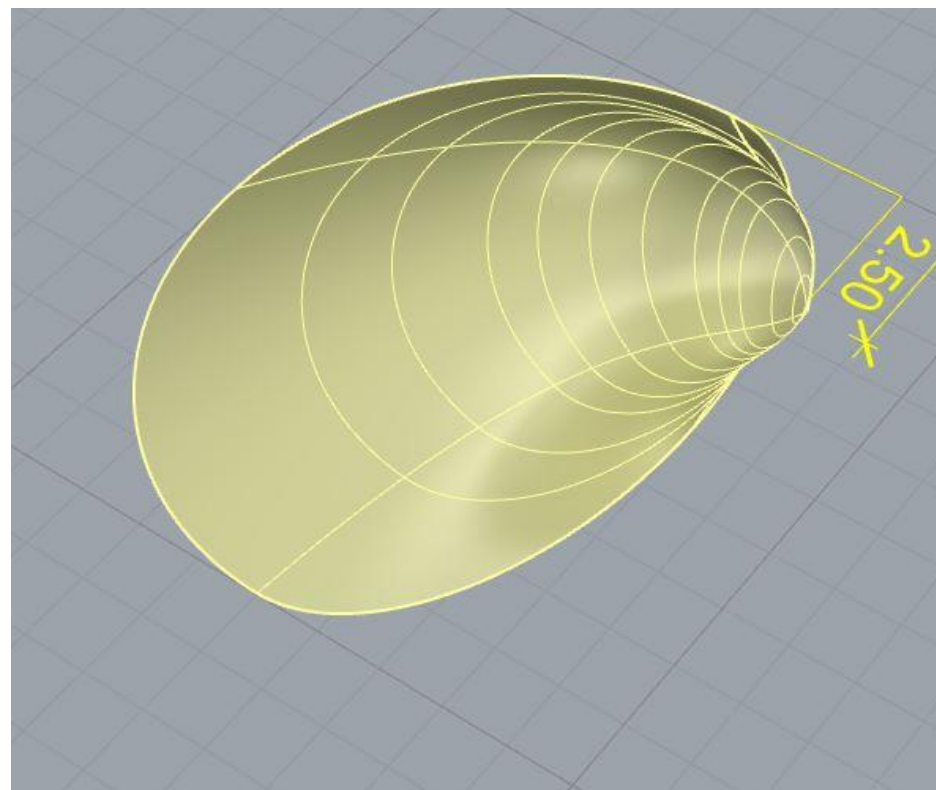
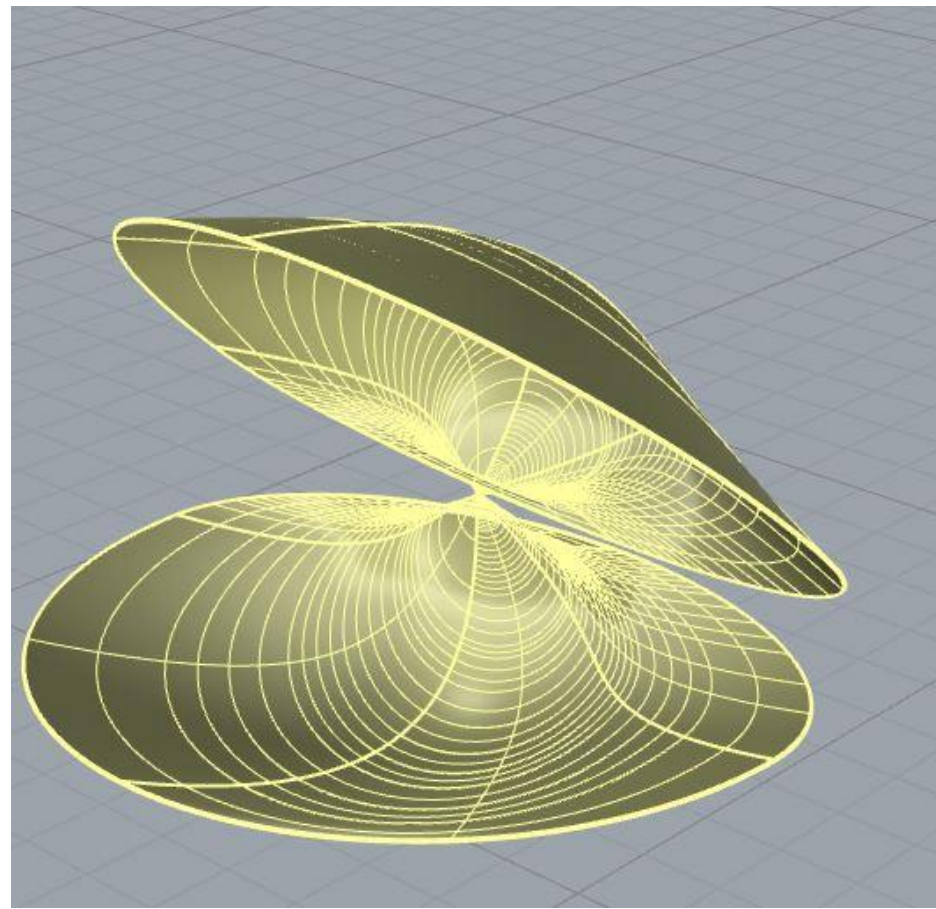

Exerc. 5.2 - Ameijoa



Exerc. 5.3 - Vieira

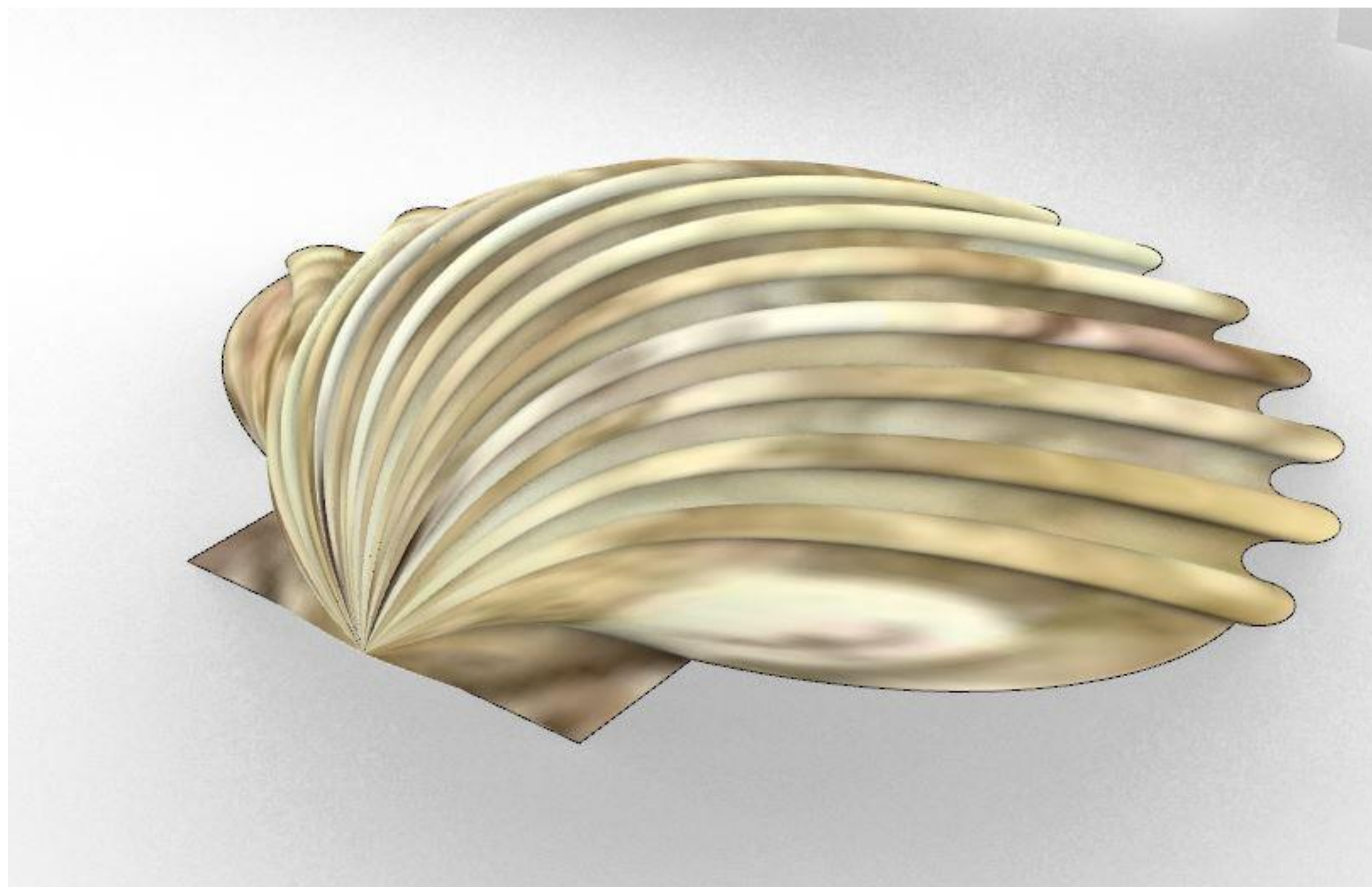
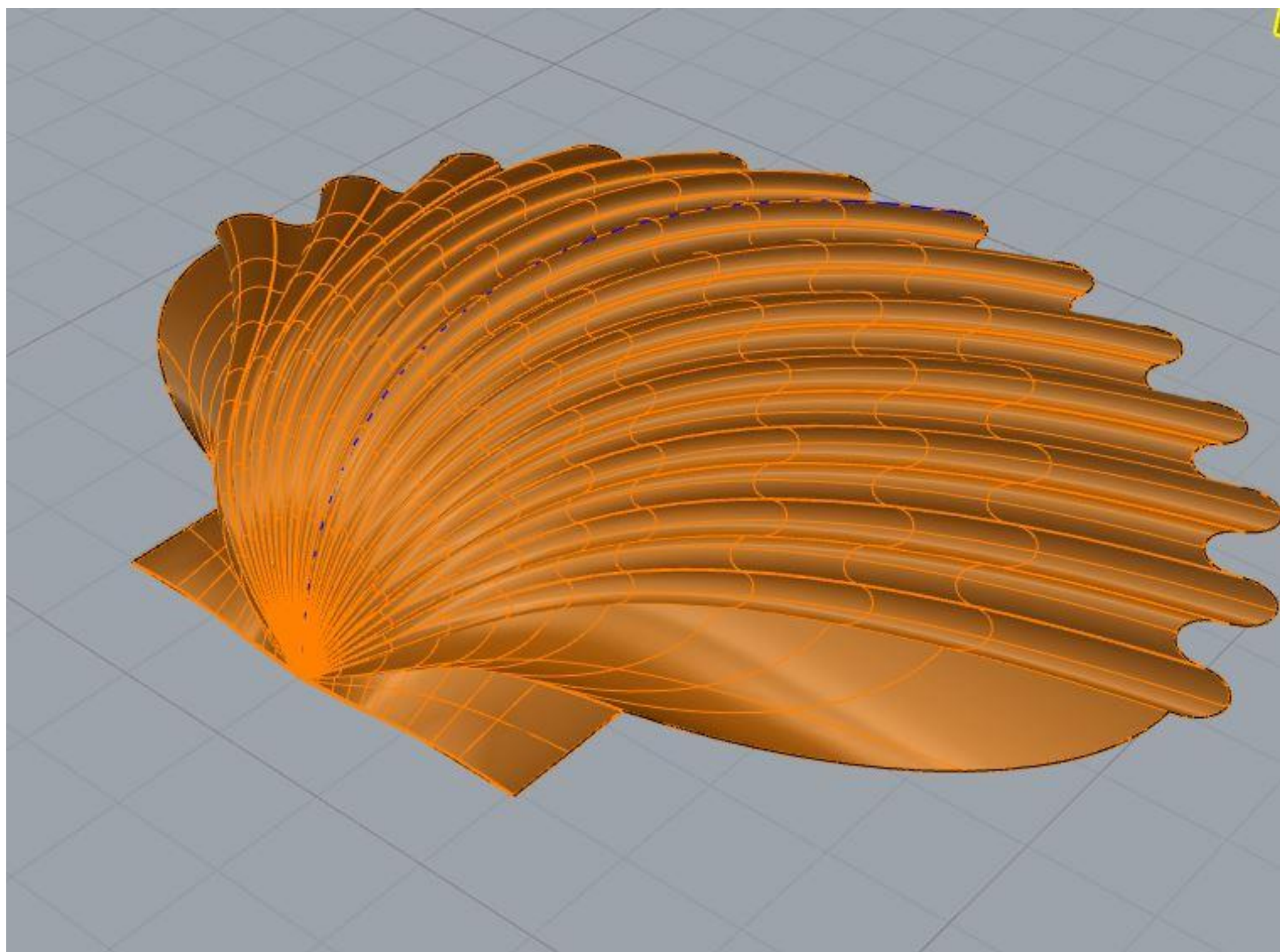

Exerc. 5.3 - Vieira



Exerc. 5.4 - Ostra

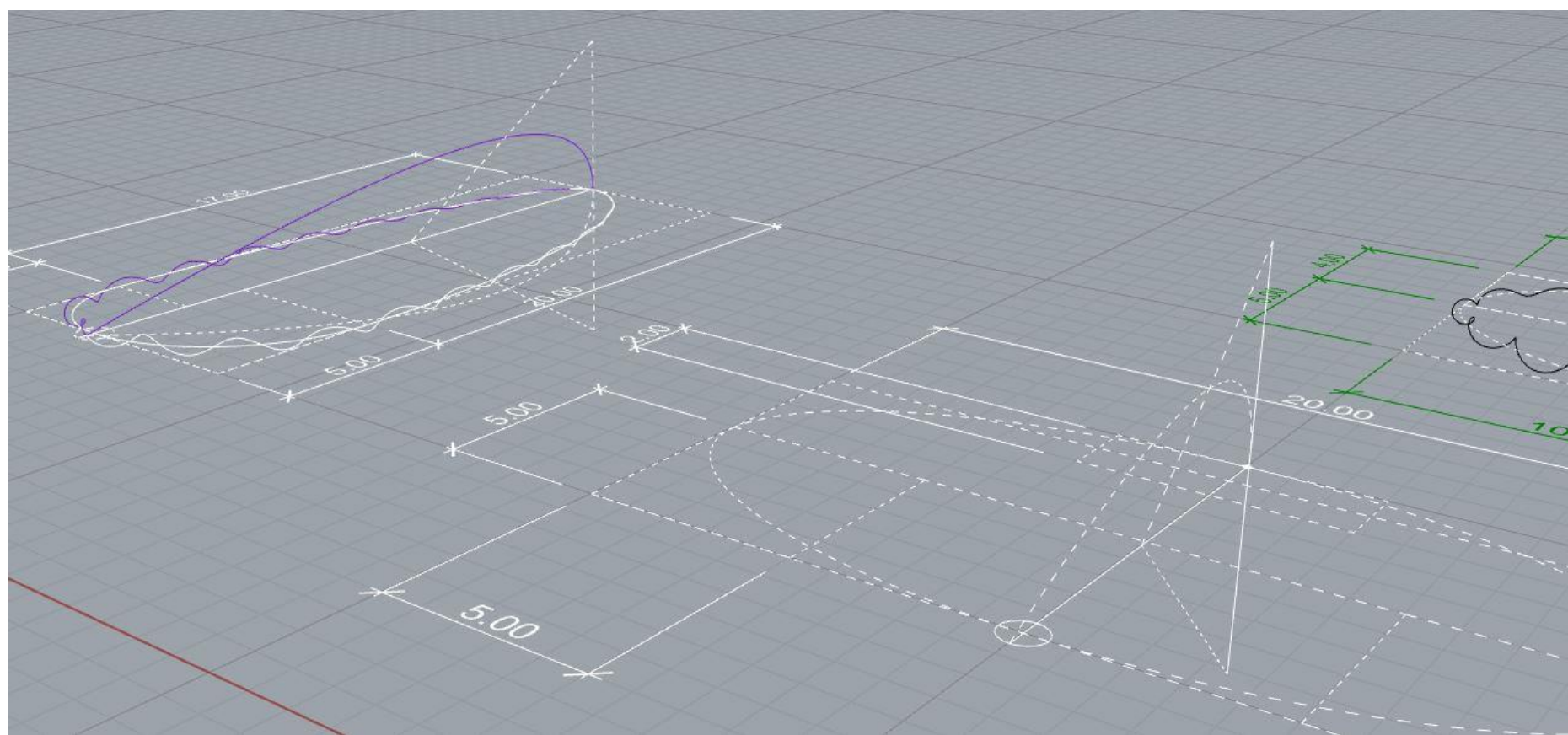
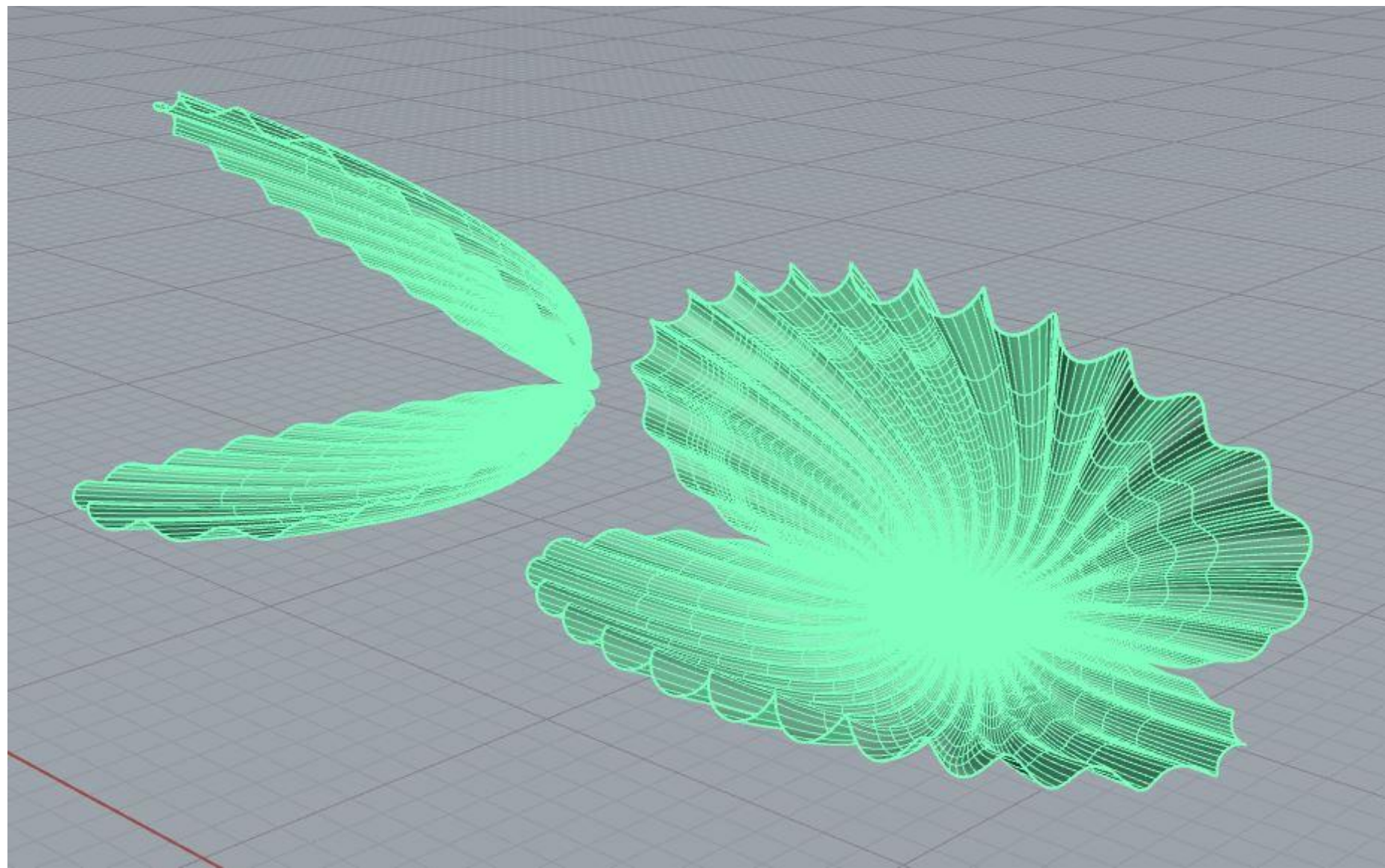

Exerc. 5.4 - Ostra

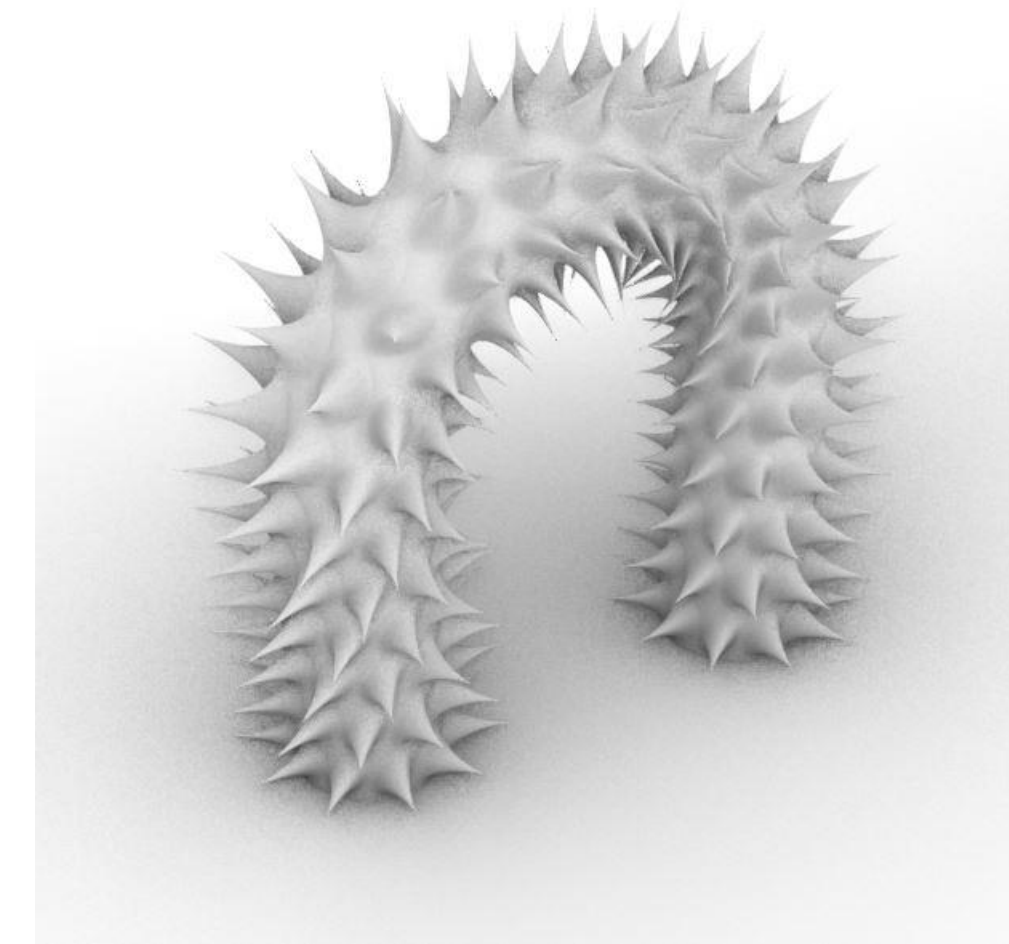
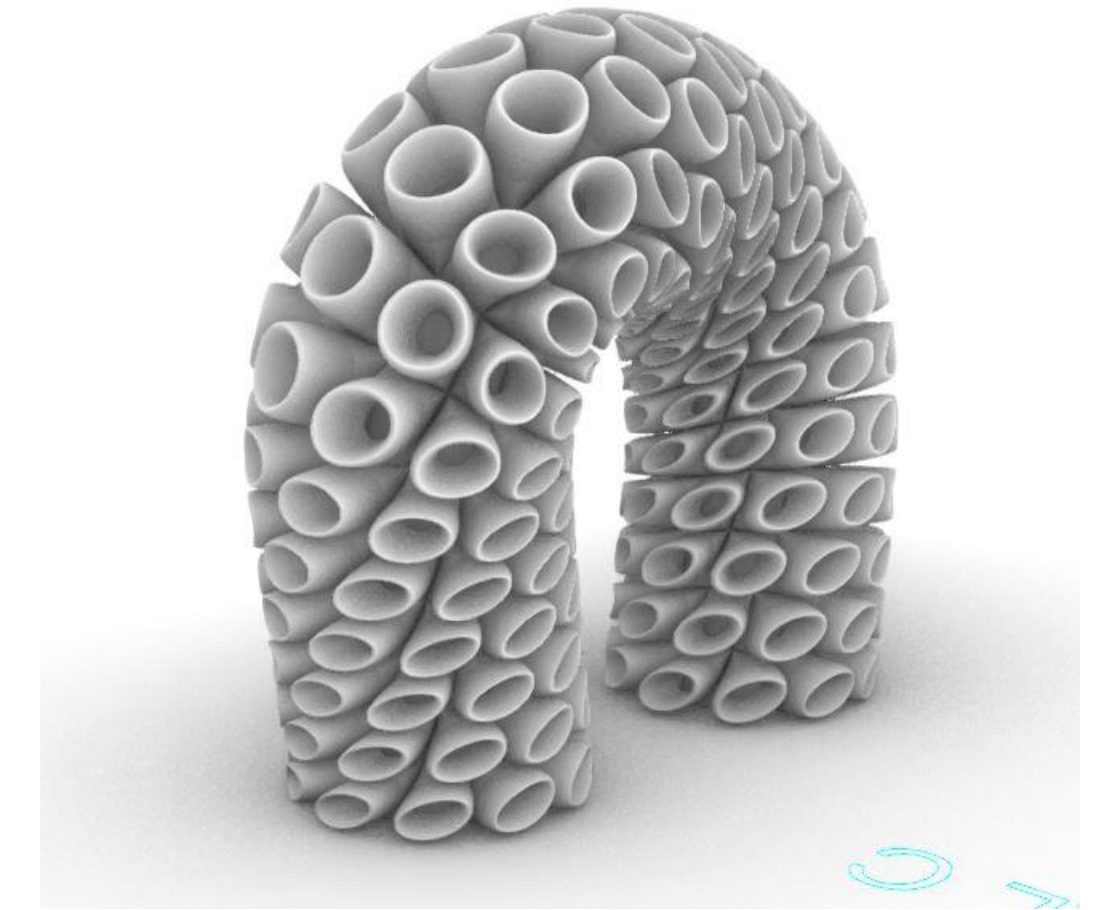
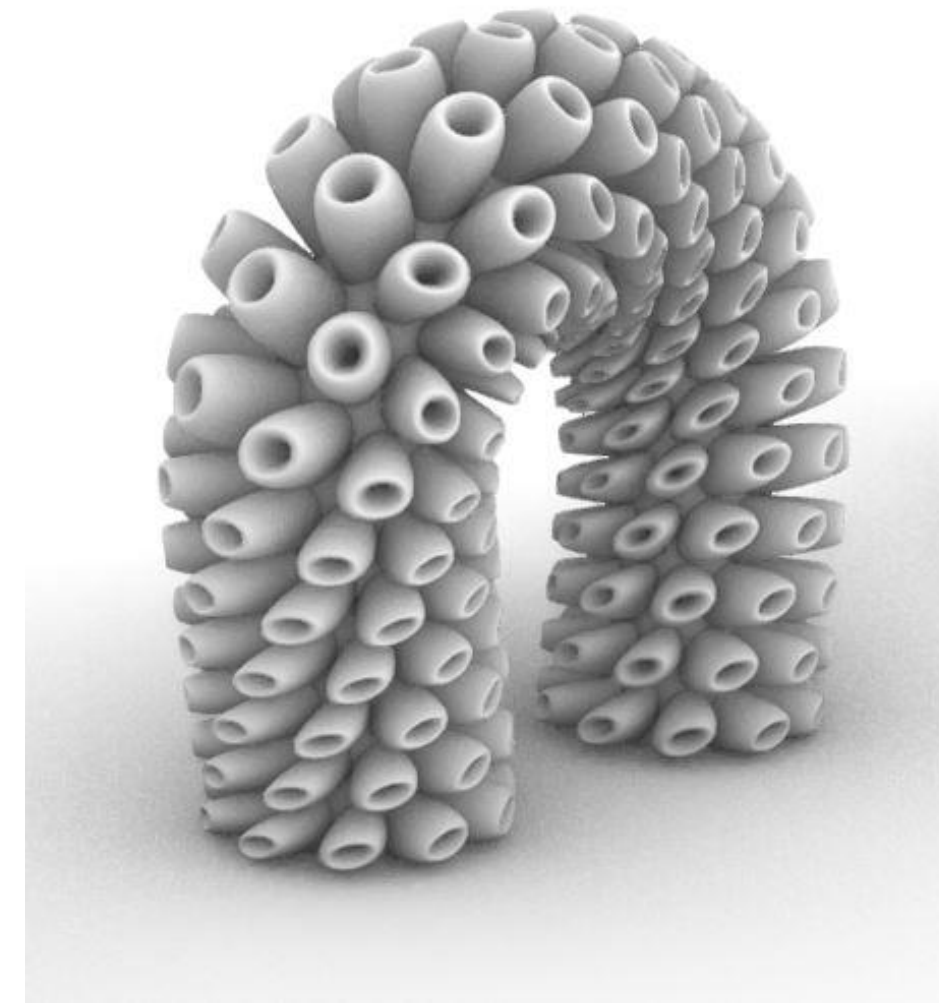

Exerc. 7 - Corais

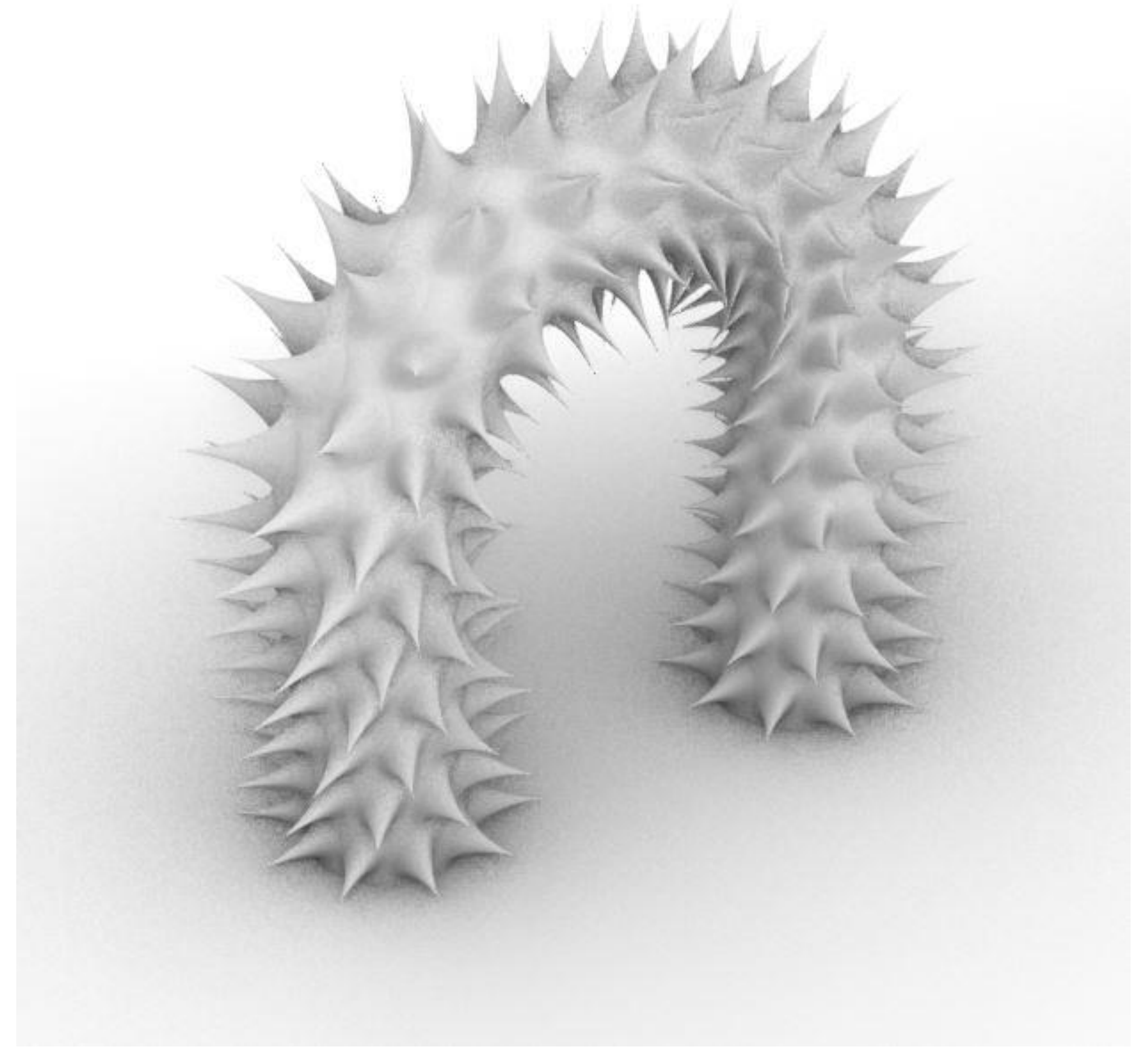

Exerc. 7 - Corais

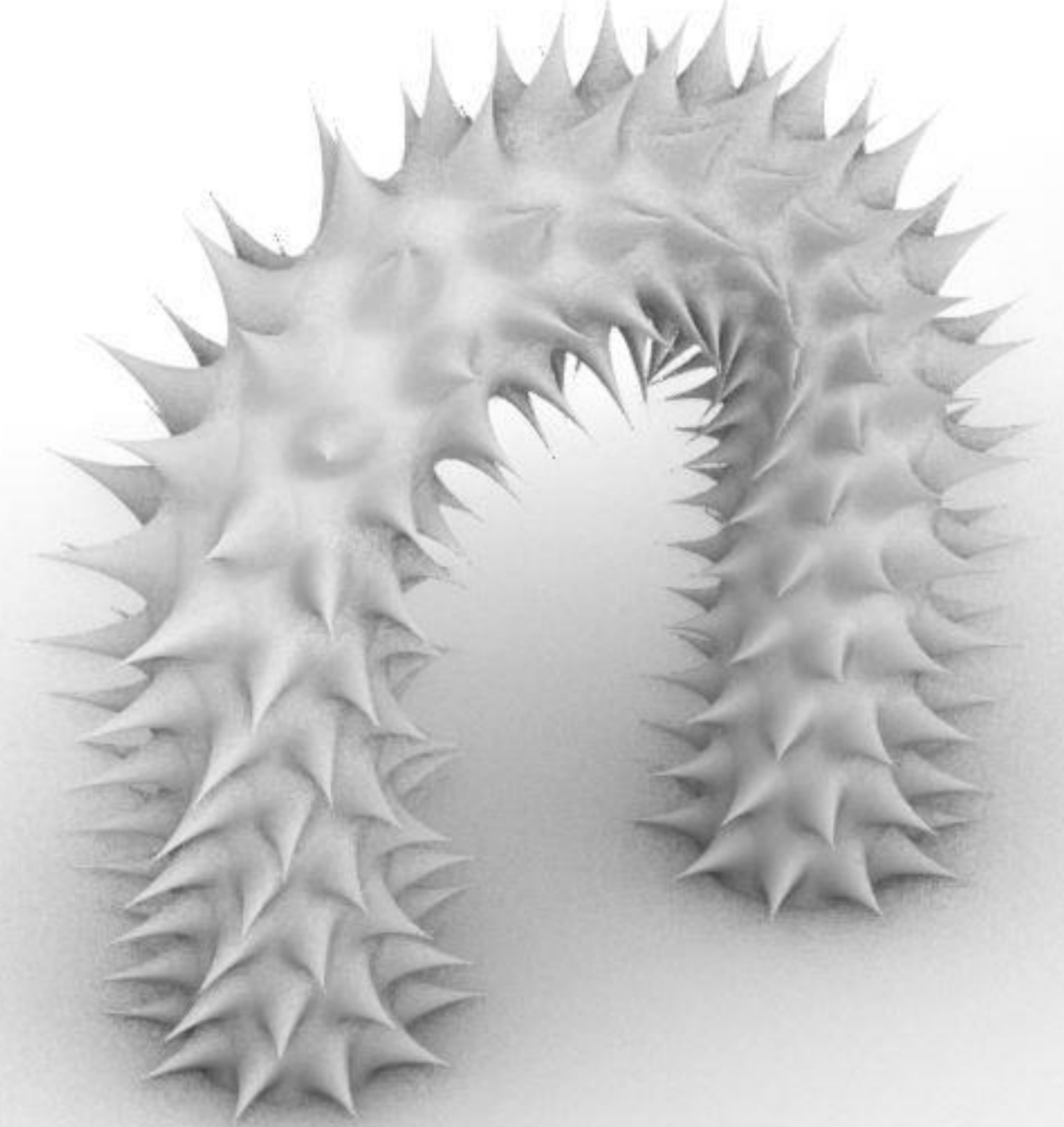
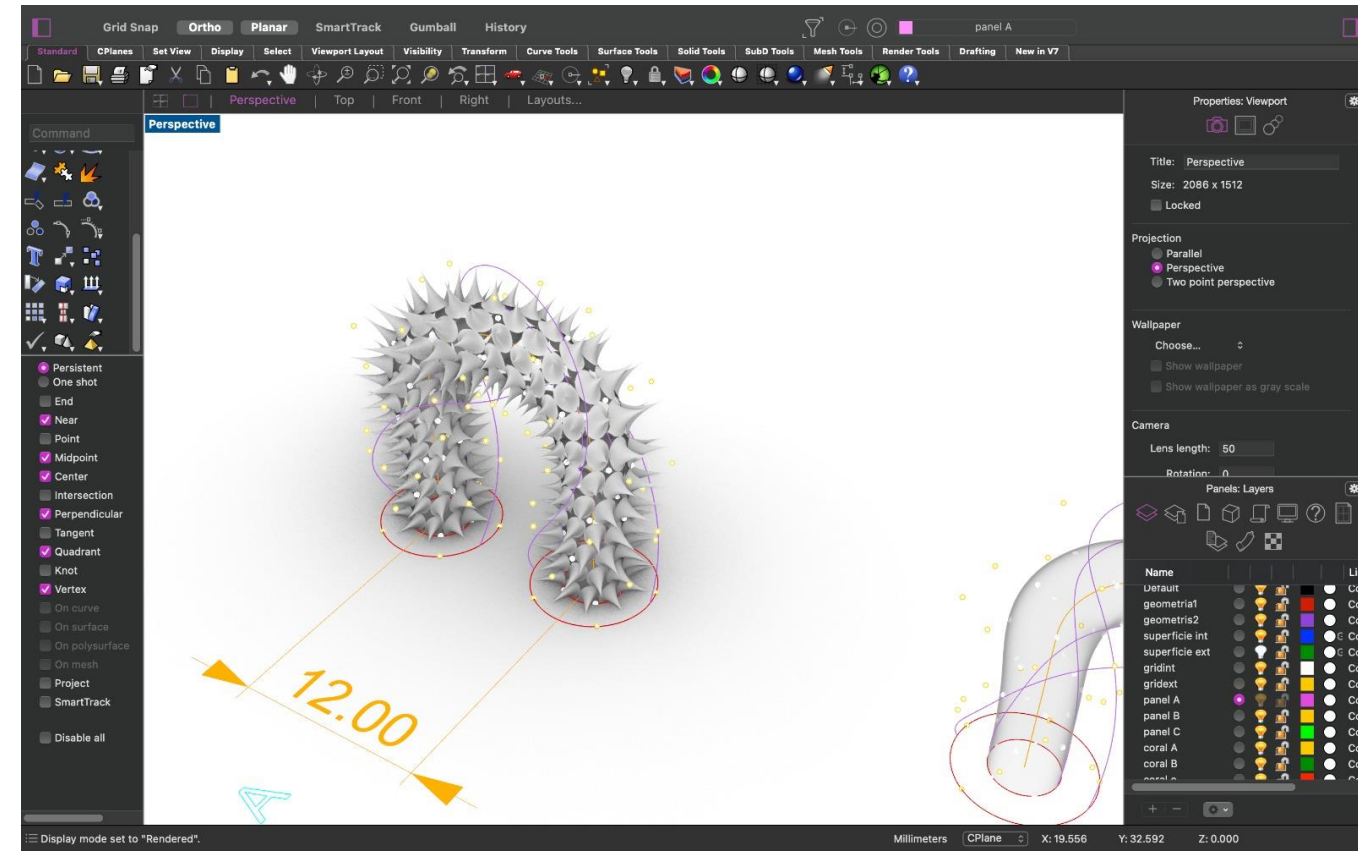
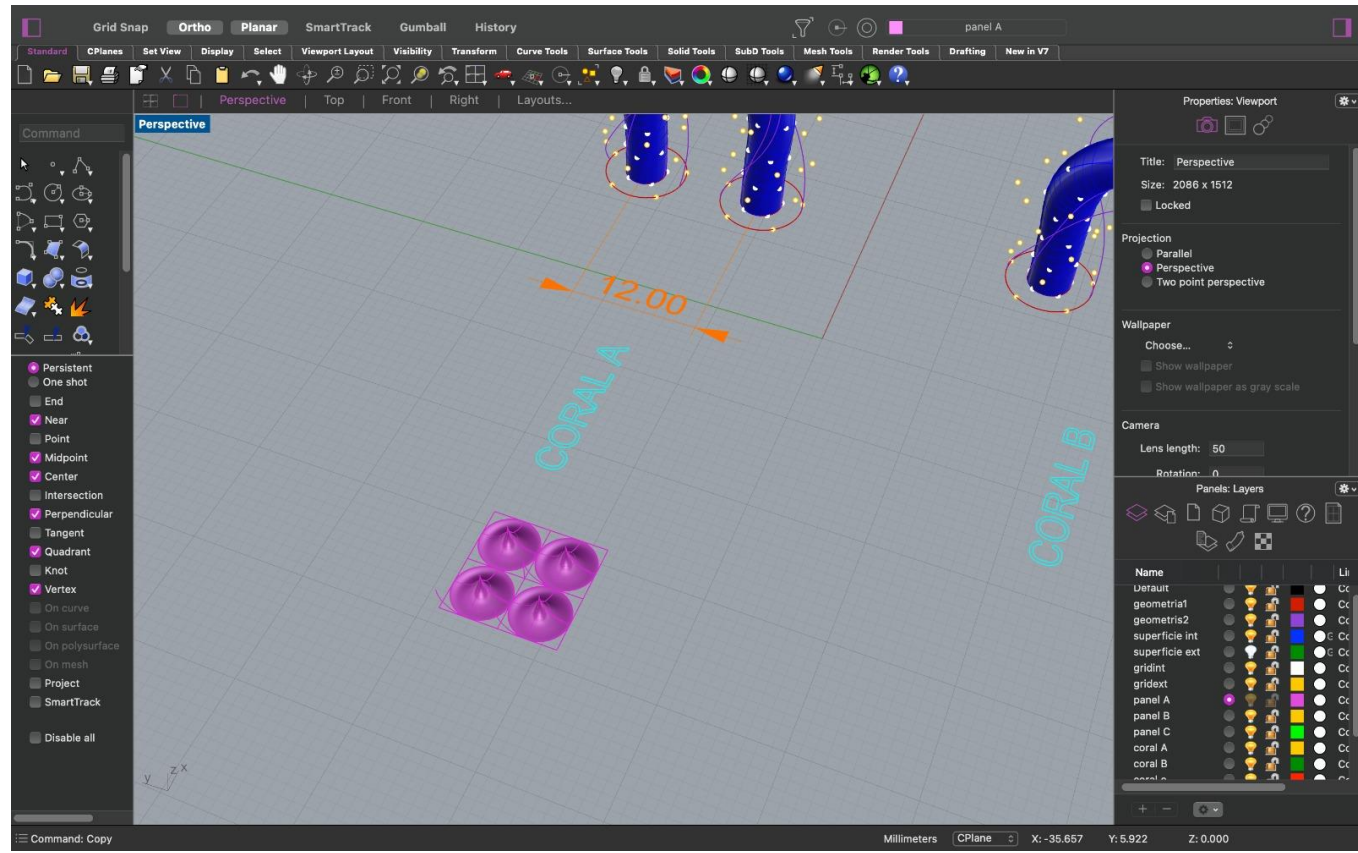
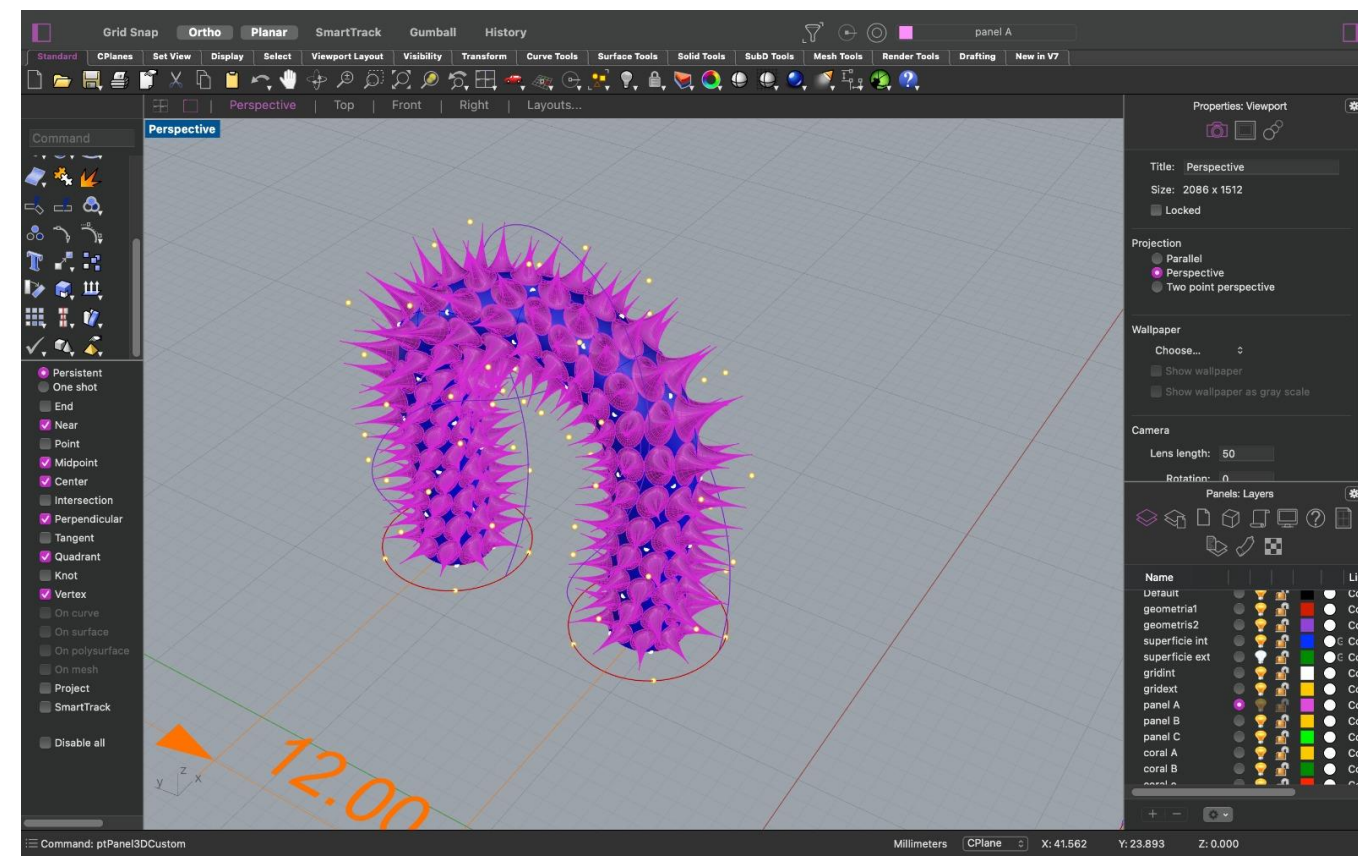
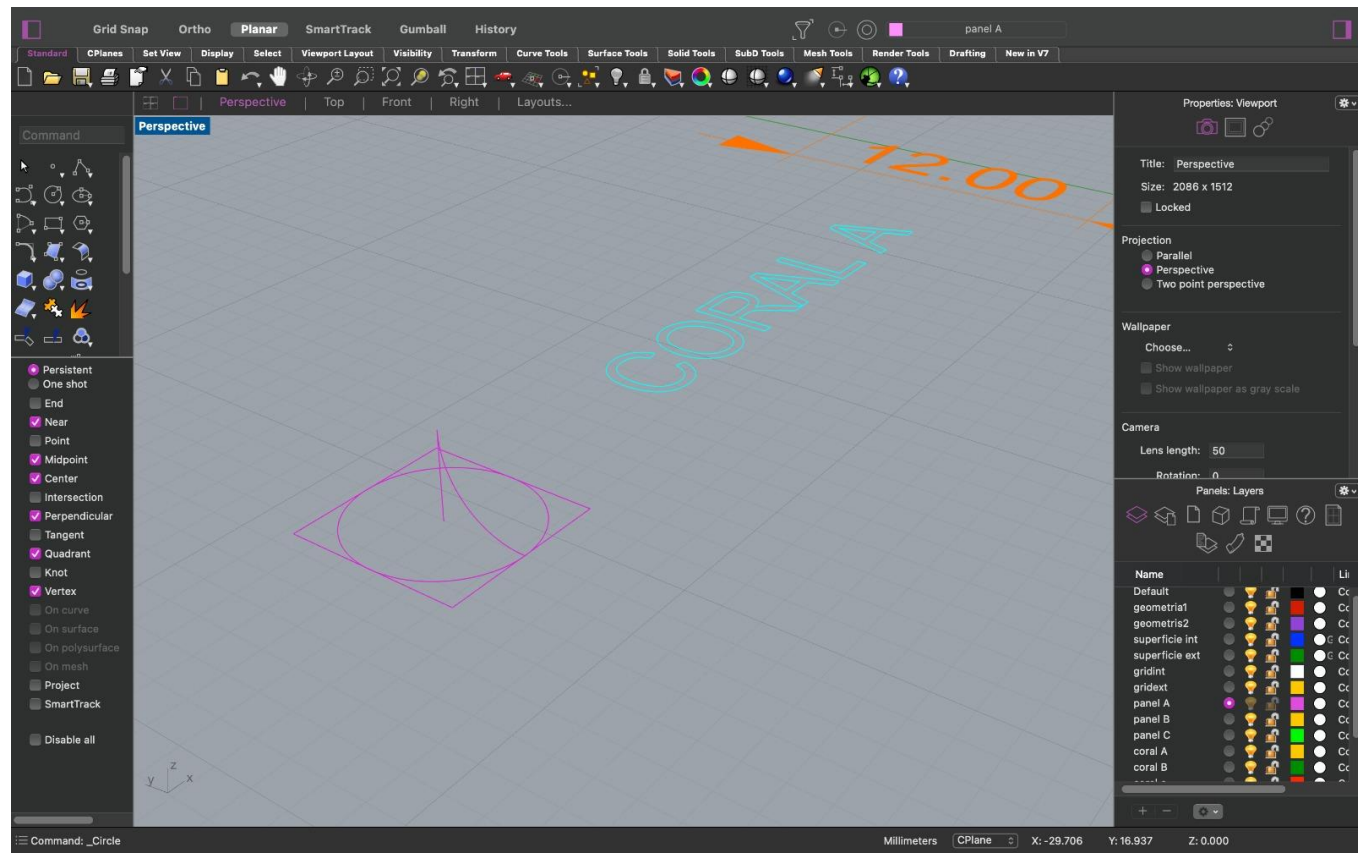

Exerc. 7.1 – Coral A

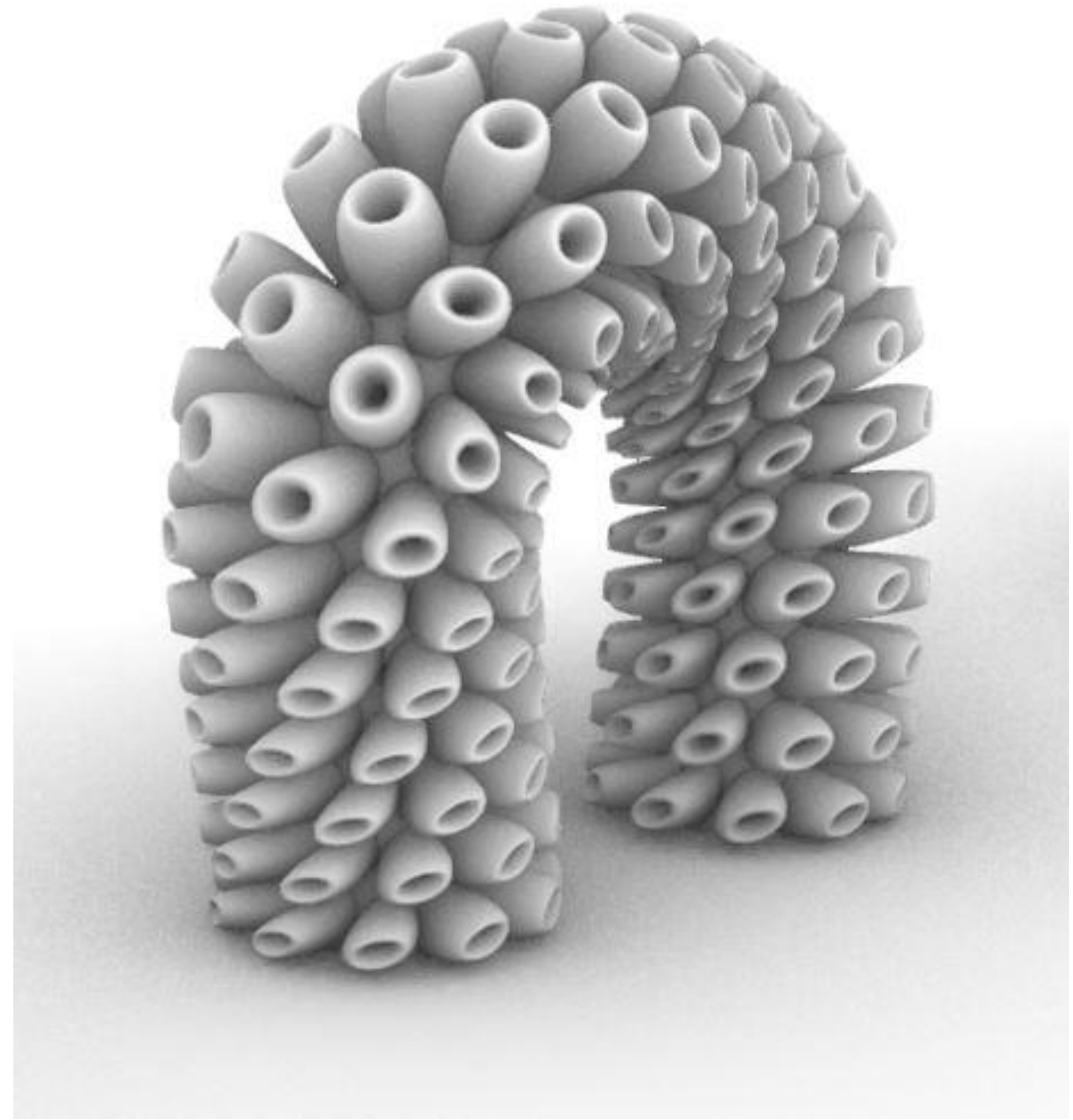

Exerc. 7.3 – Coral 3

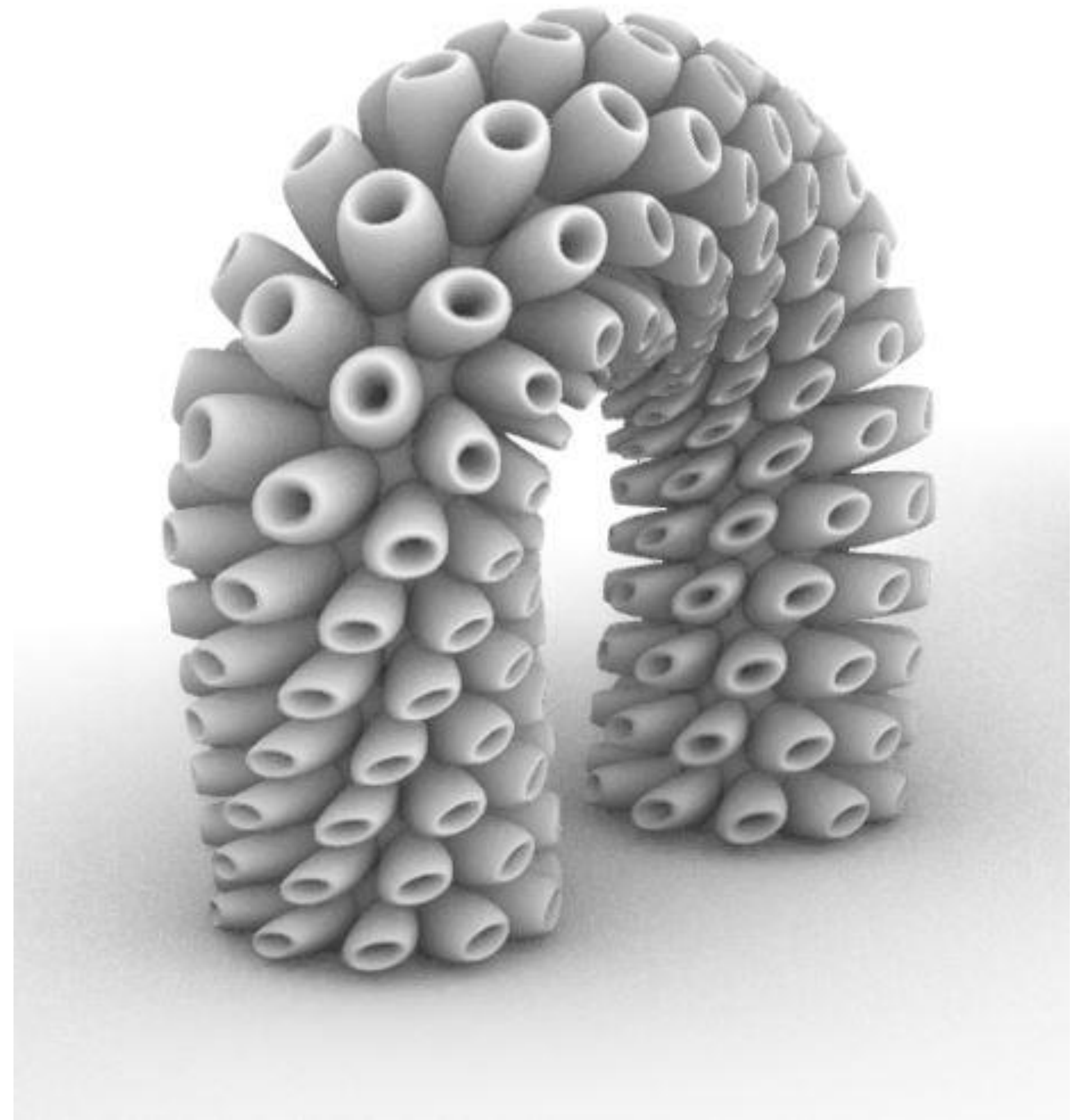
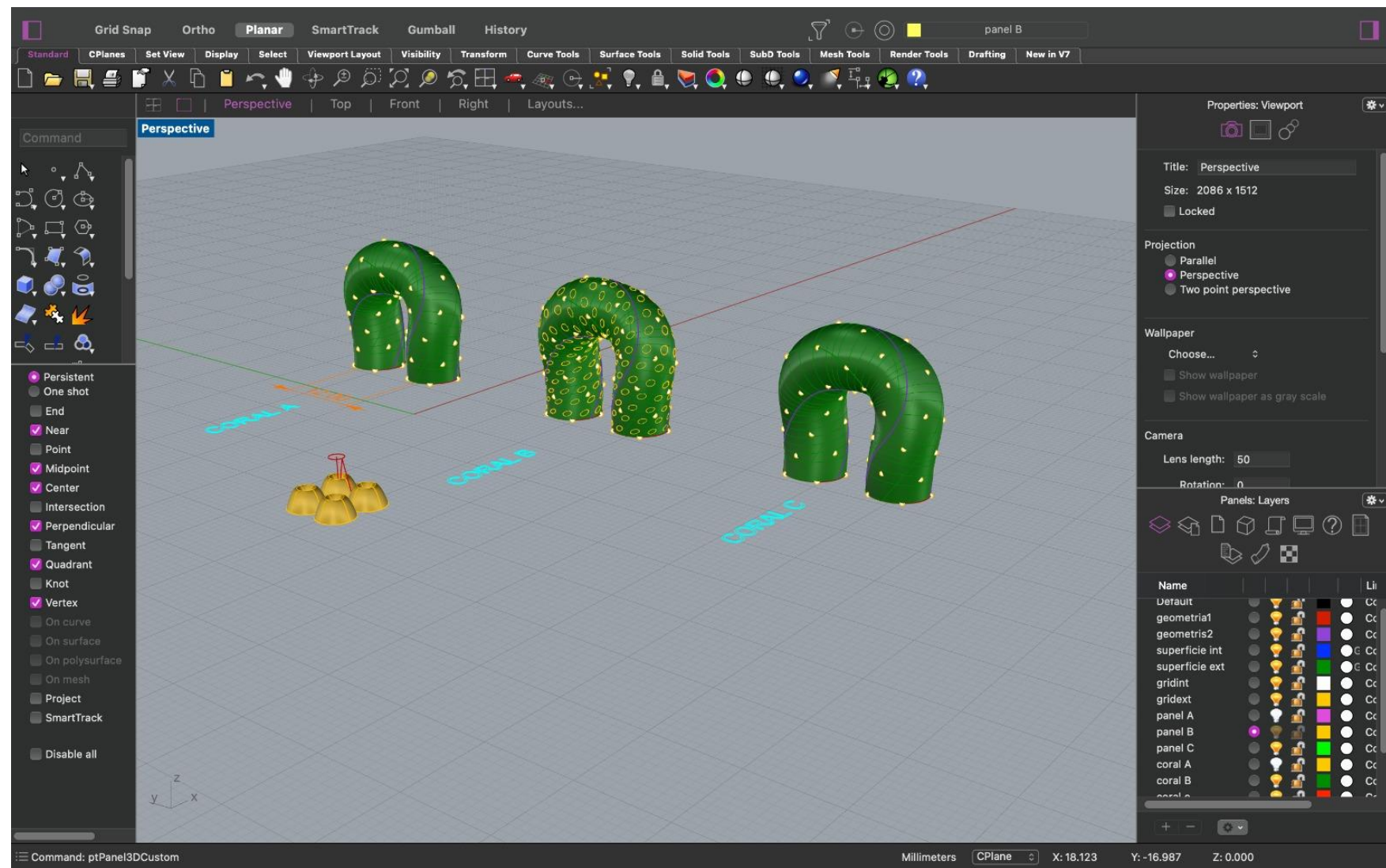
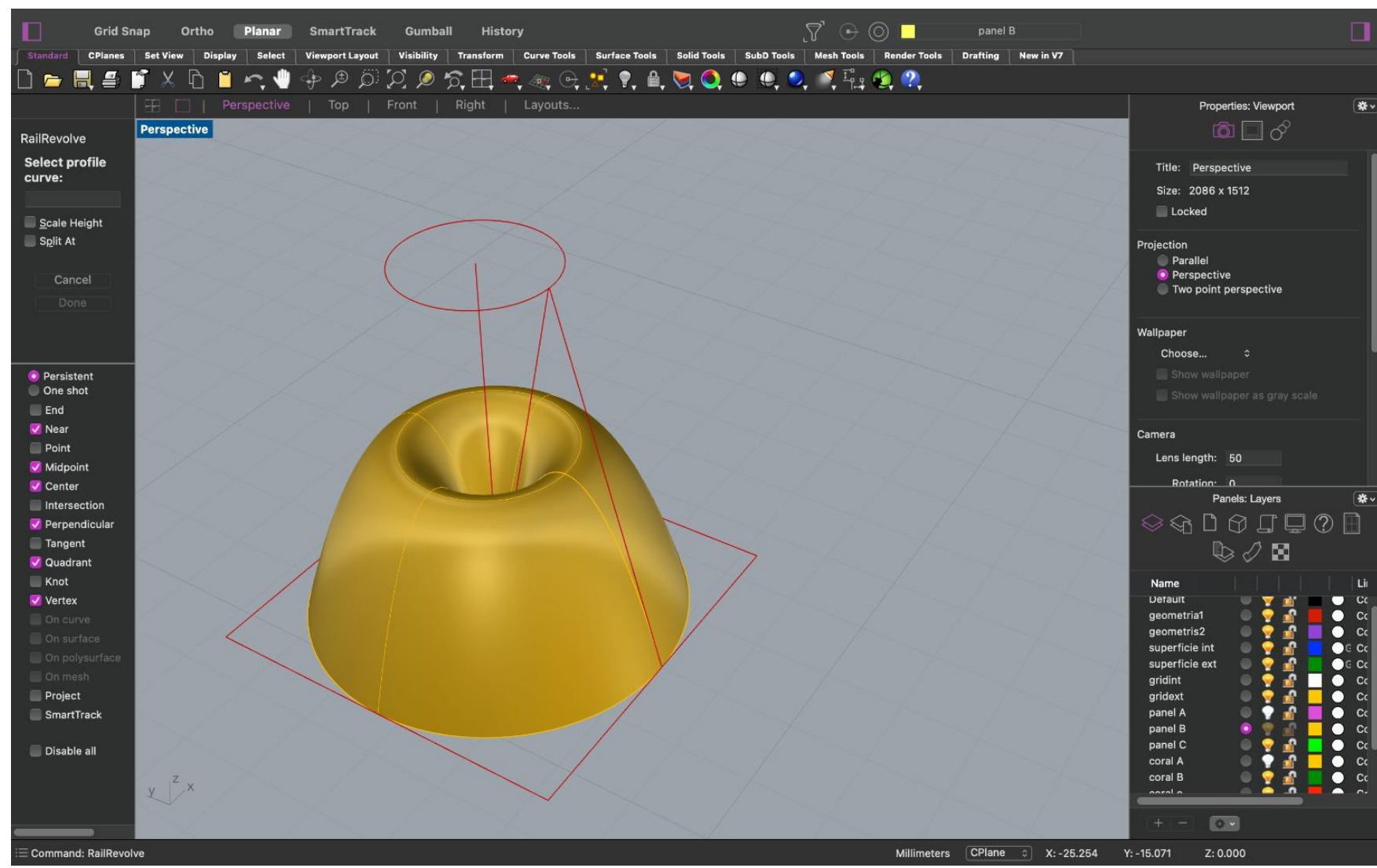

Exerc. 7.3 – Coral 3

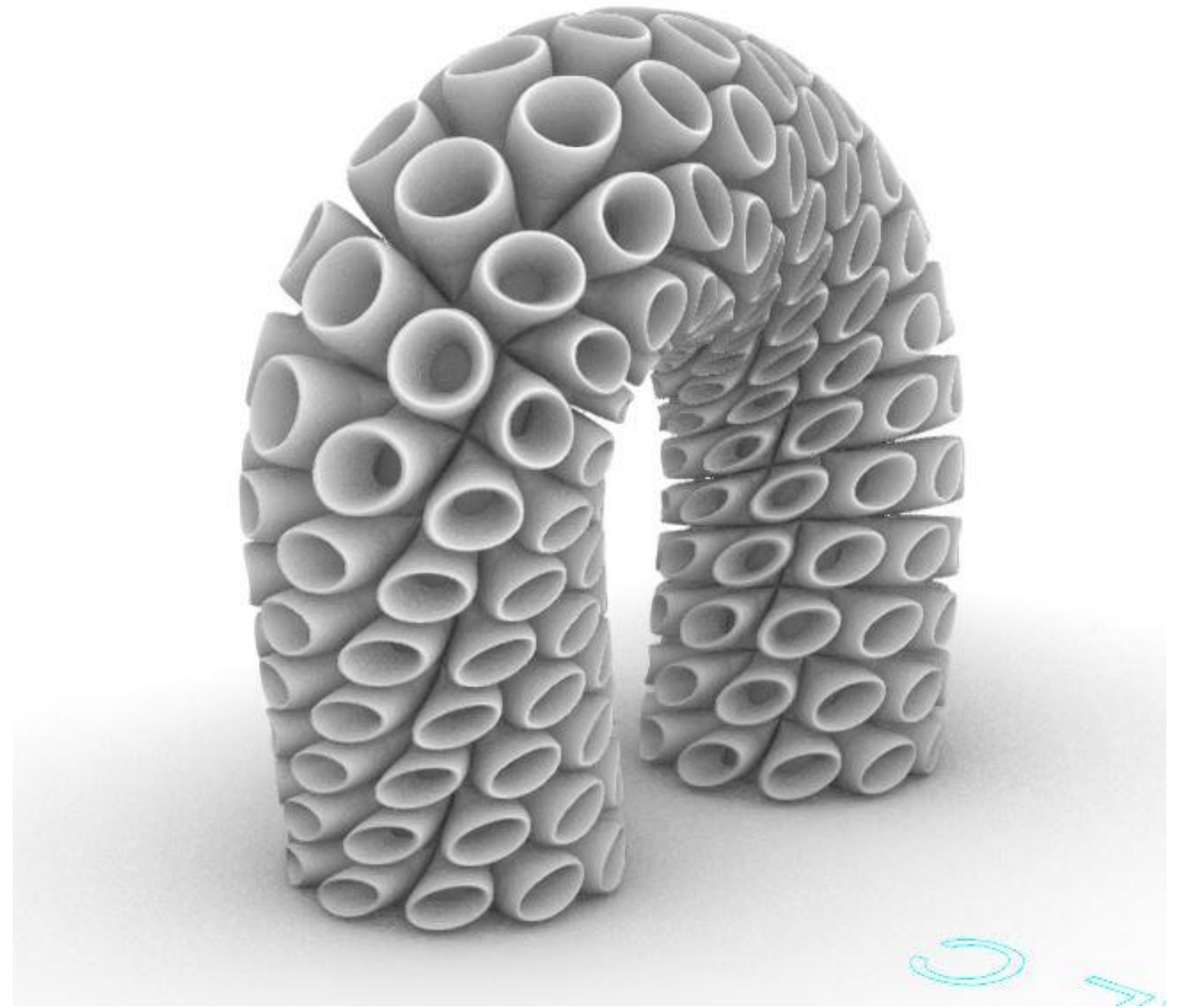

Exerc. 7.4 – Coral 4

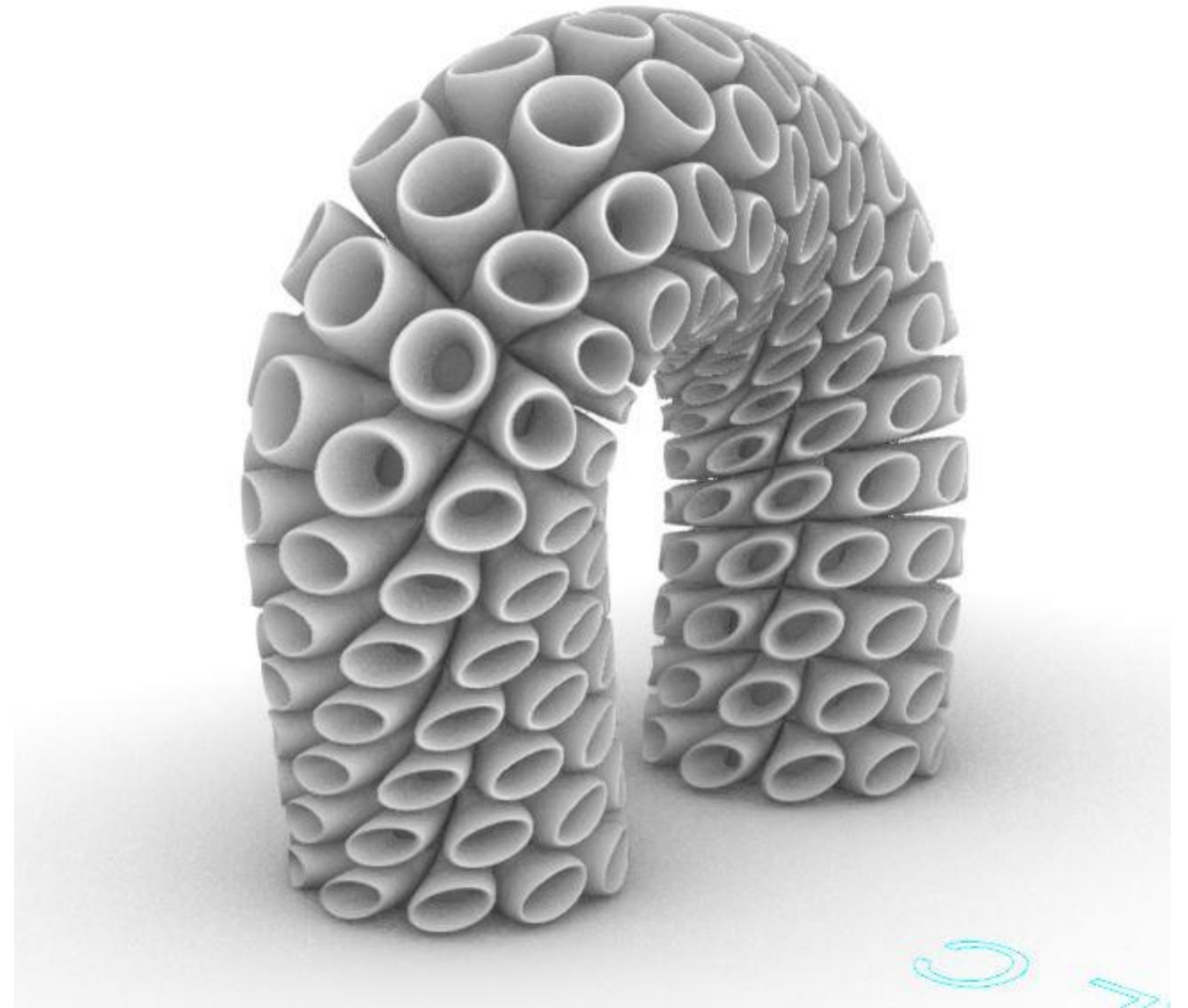
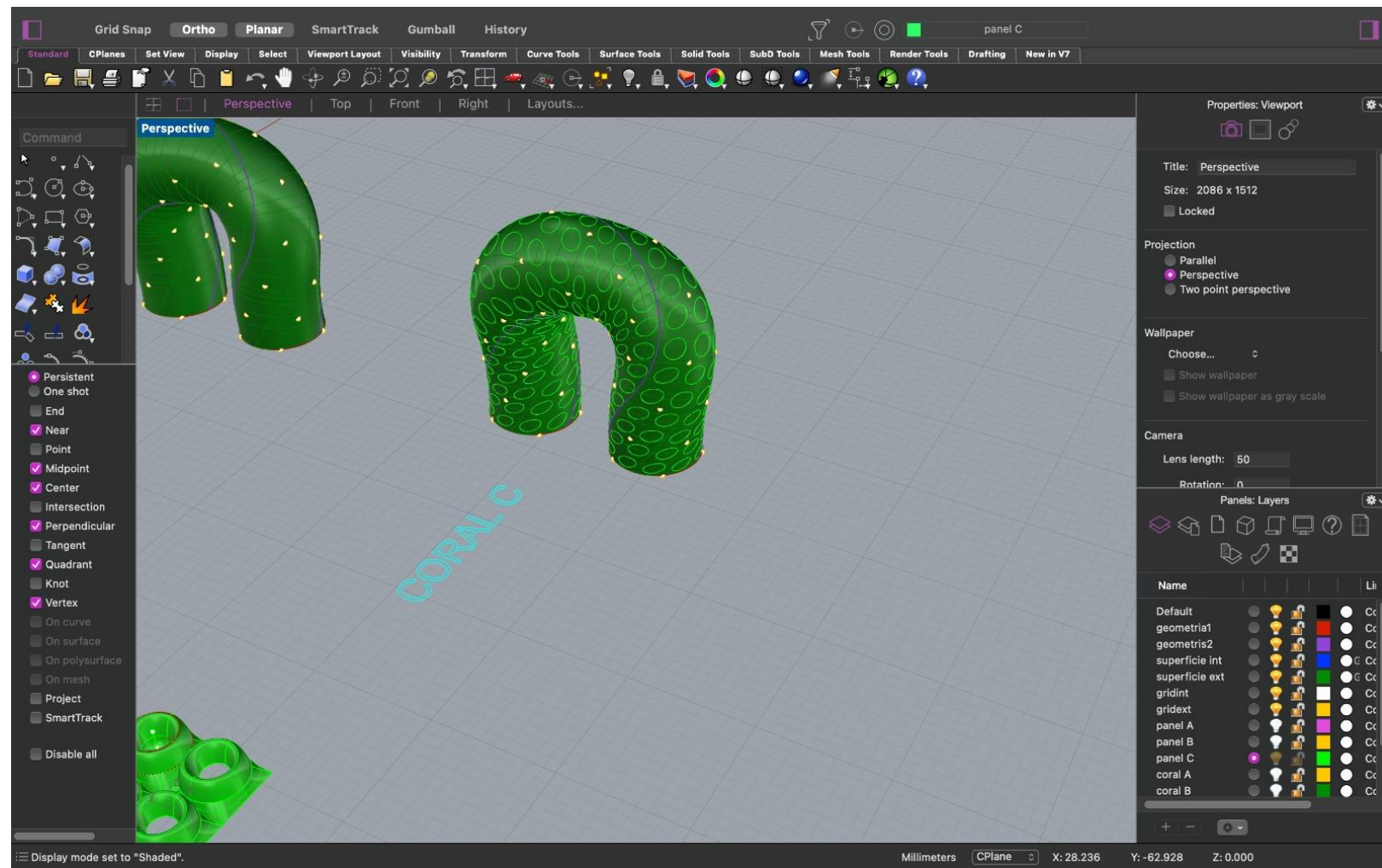
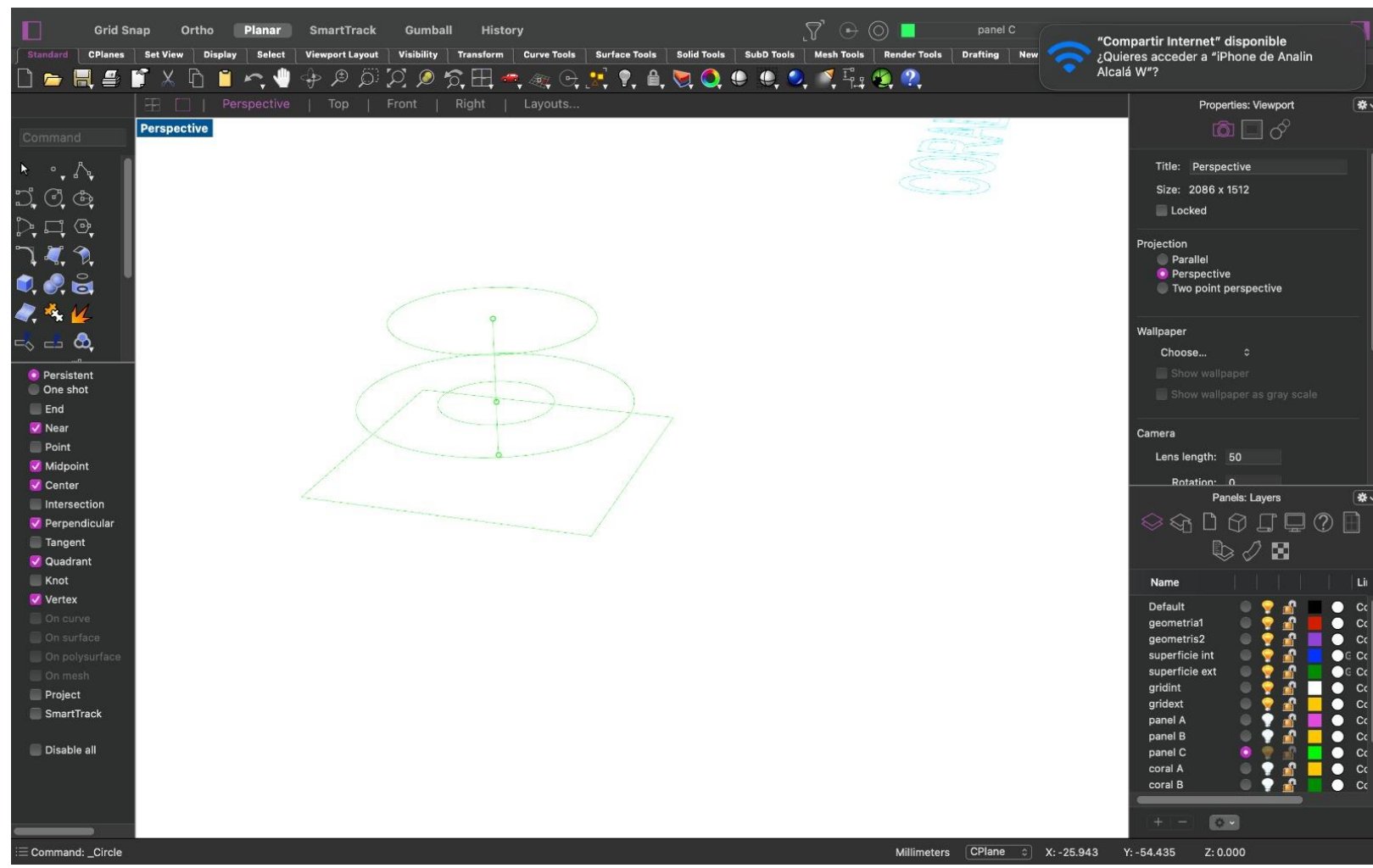

Exerc. 7.4 – Coral 4