

AULA 5 _ 4 de novembro de 2021

- _ Execução do exercício (3.1) Mexilhão;
- _ Execução do exercício (3.2) Ameijoa;
- _ Execução do exercício (3.3) Vieira.

NOTAS E COMANDOS:

CIRCLE

TRIM

ARC

DIM

SURFACE _ REVOLVE

PROJECT CURVES

SWEEP 2 RAILS

SPLIT

EXERCÍCIO 3.1 _ MEXILHÃO

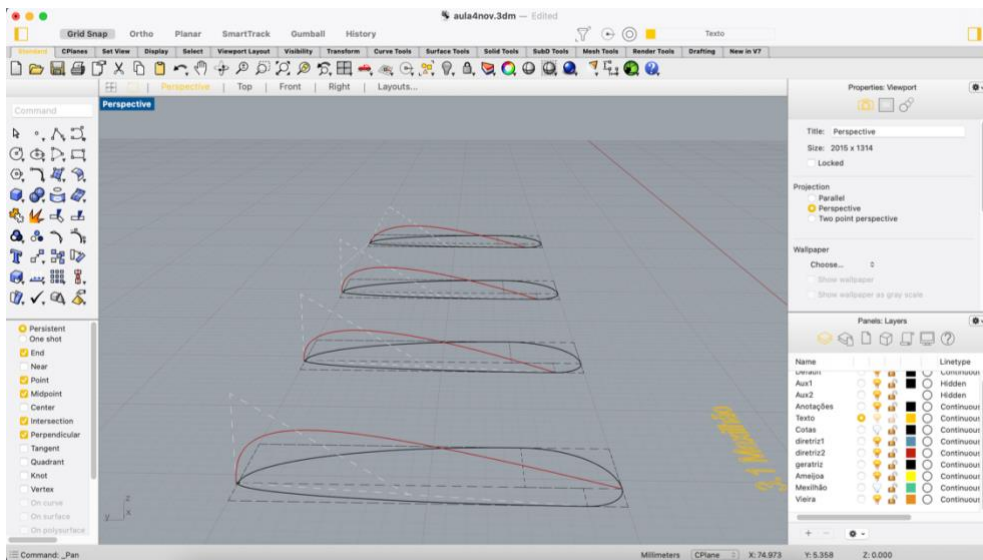
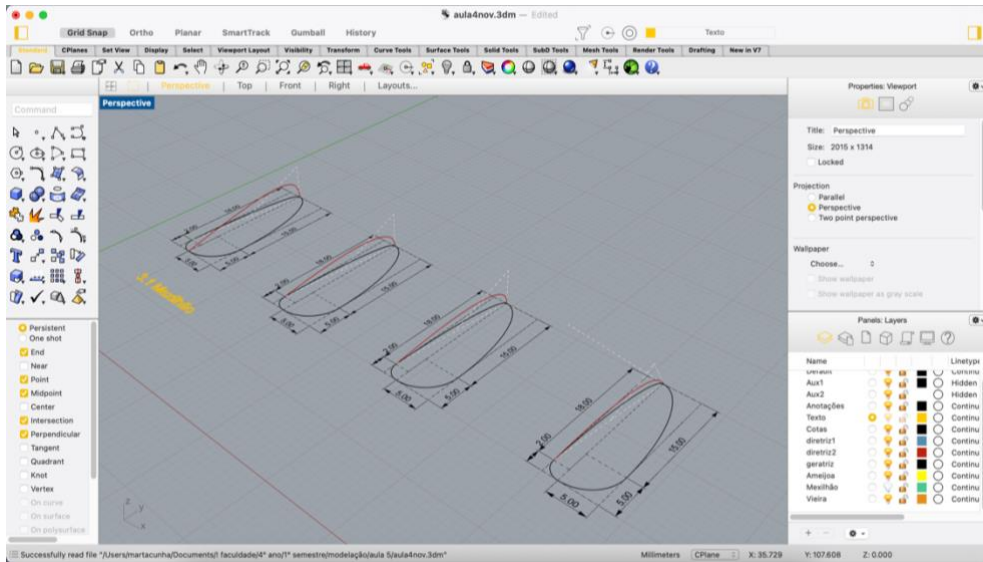
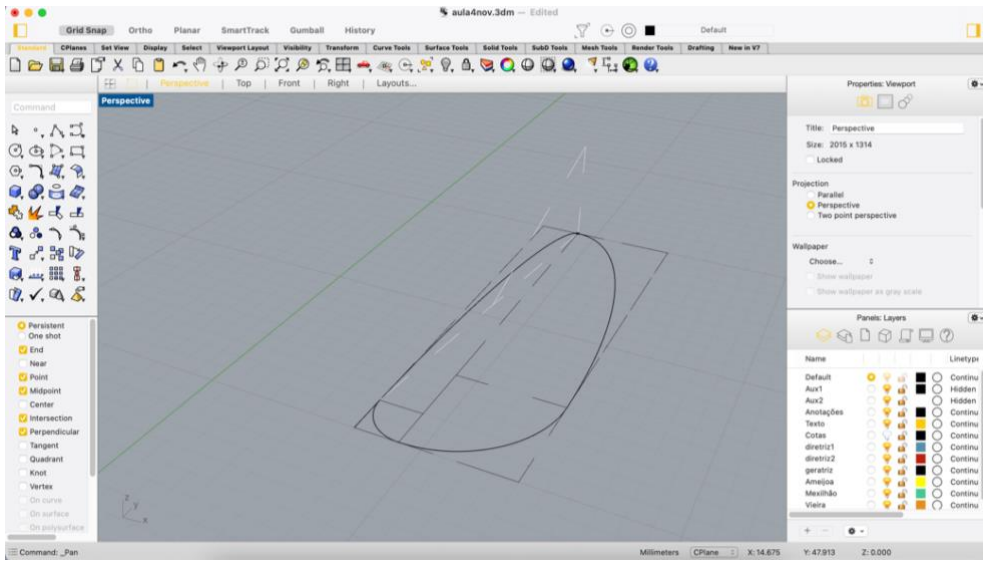

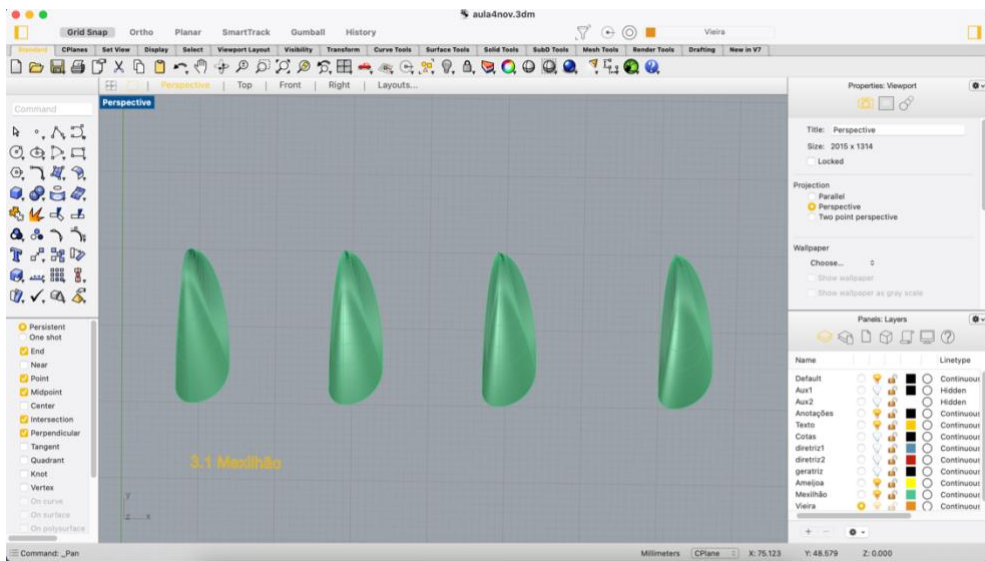
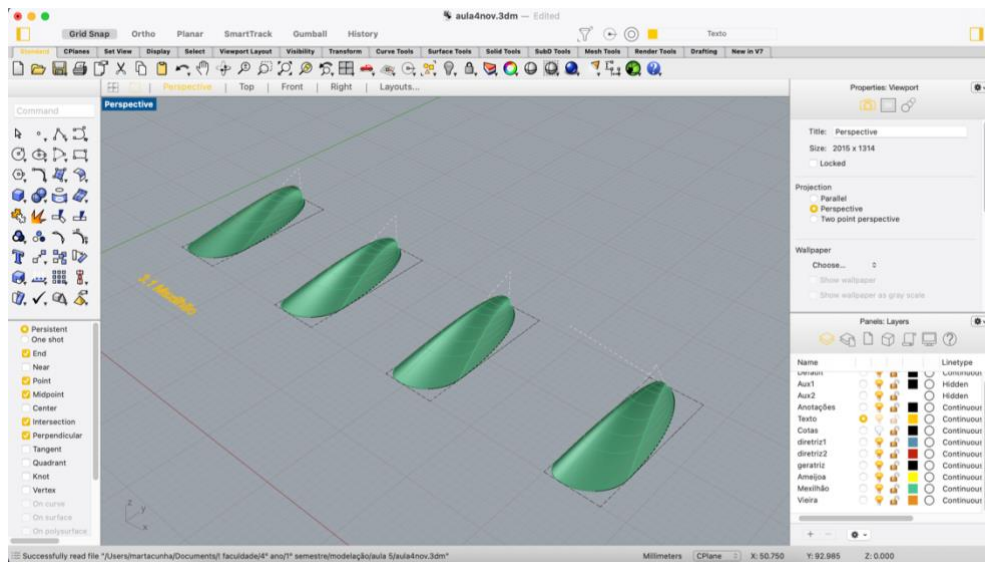
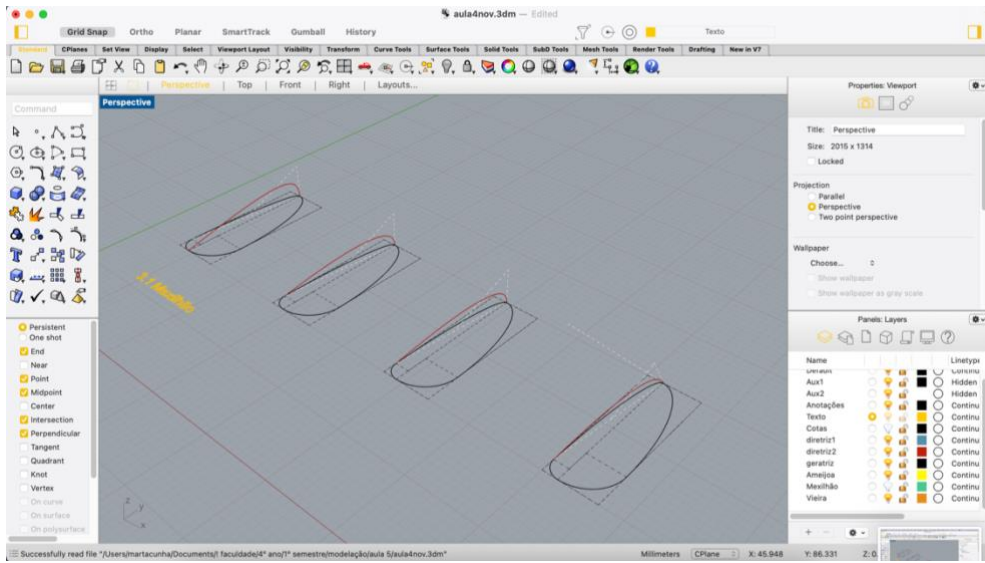

EXERCÍCIO 3.2 _ AMEIJOA

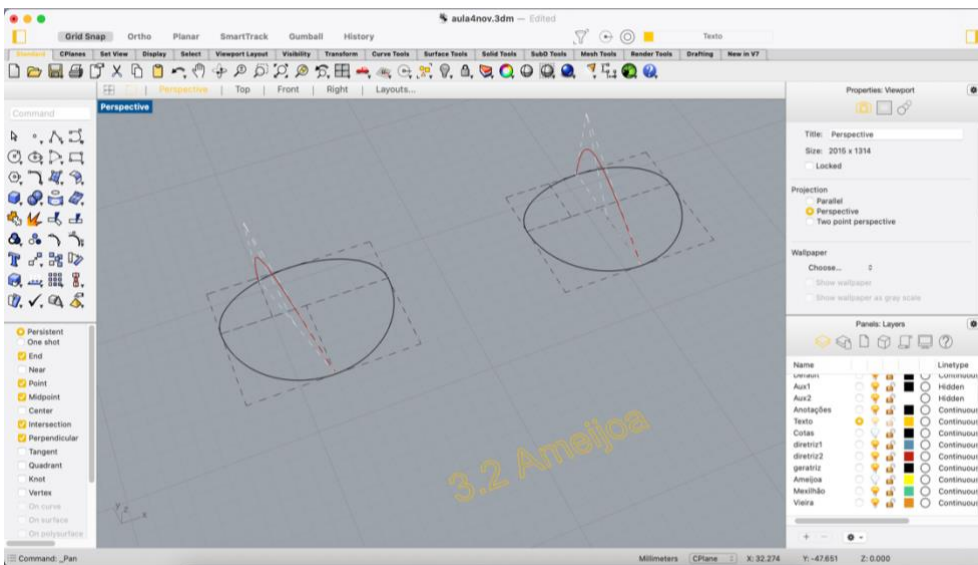
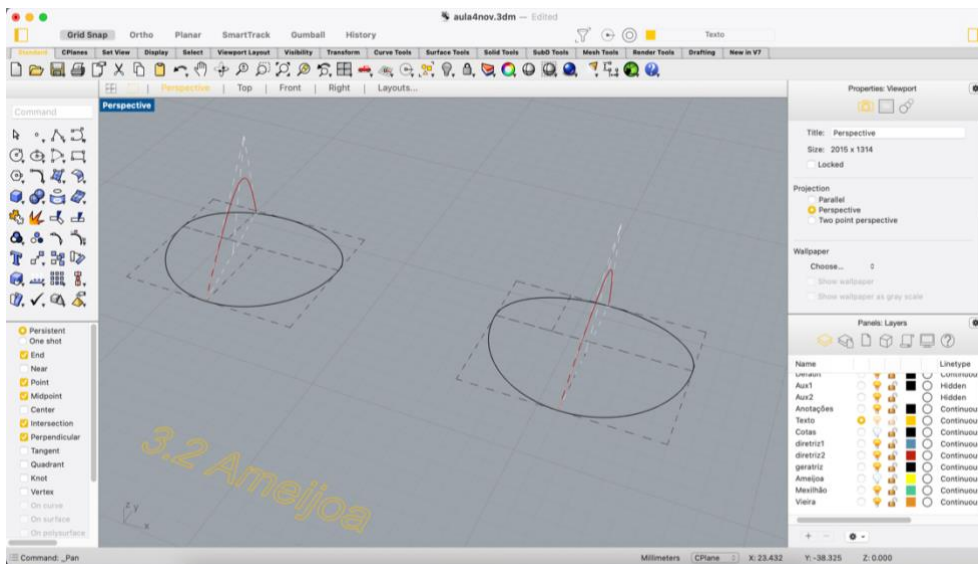
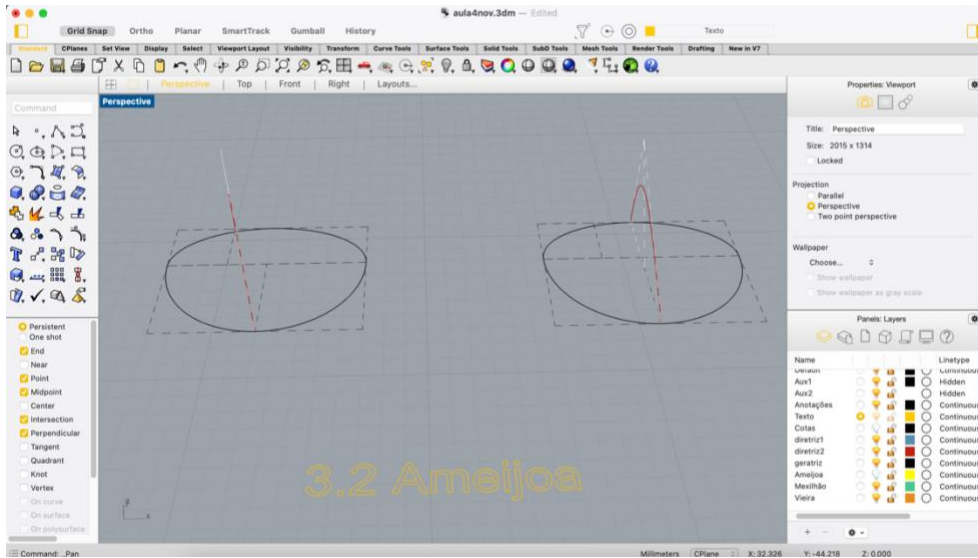

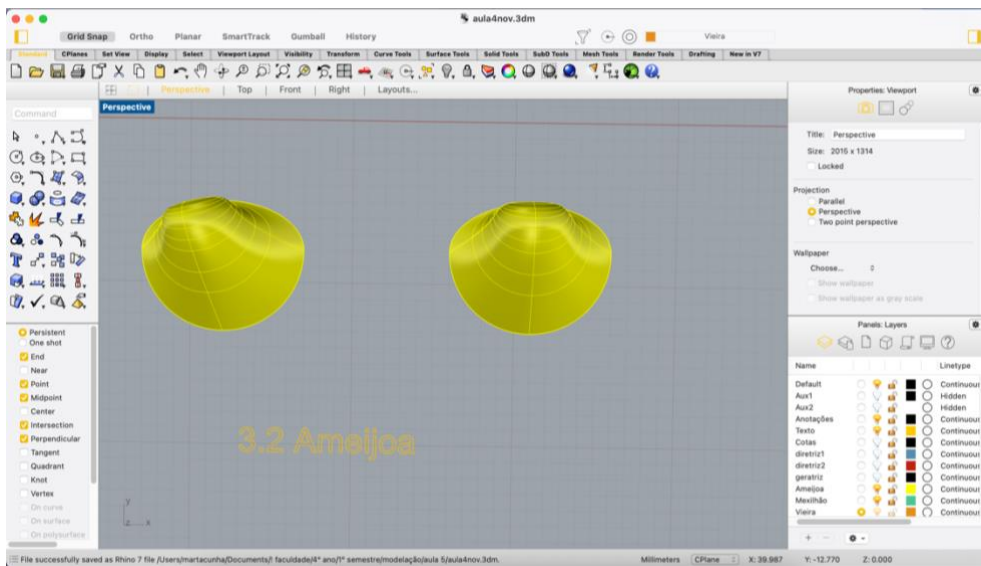
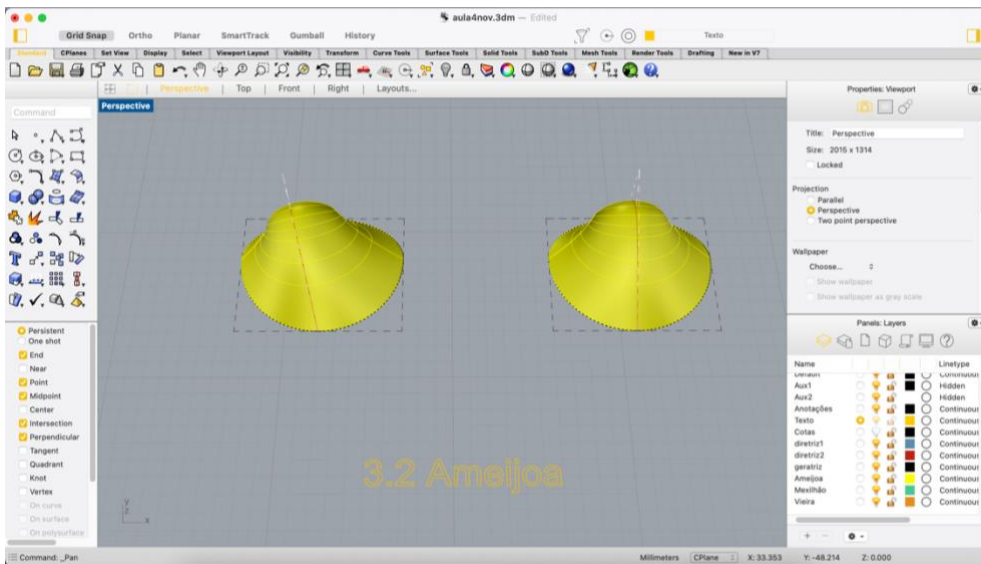
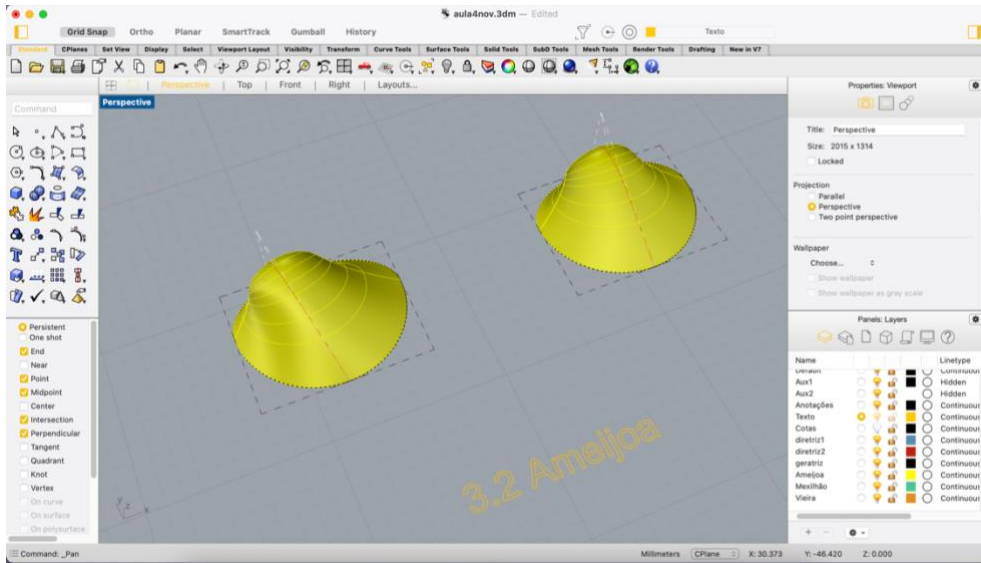

EXERCÍCIO 3.3 _ VIEIRA

