

todas as estruturas com
 uma grossura de 0,15 cm
 excepto o plástico das
 rodas 0,10 cm

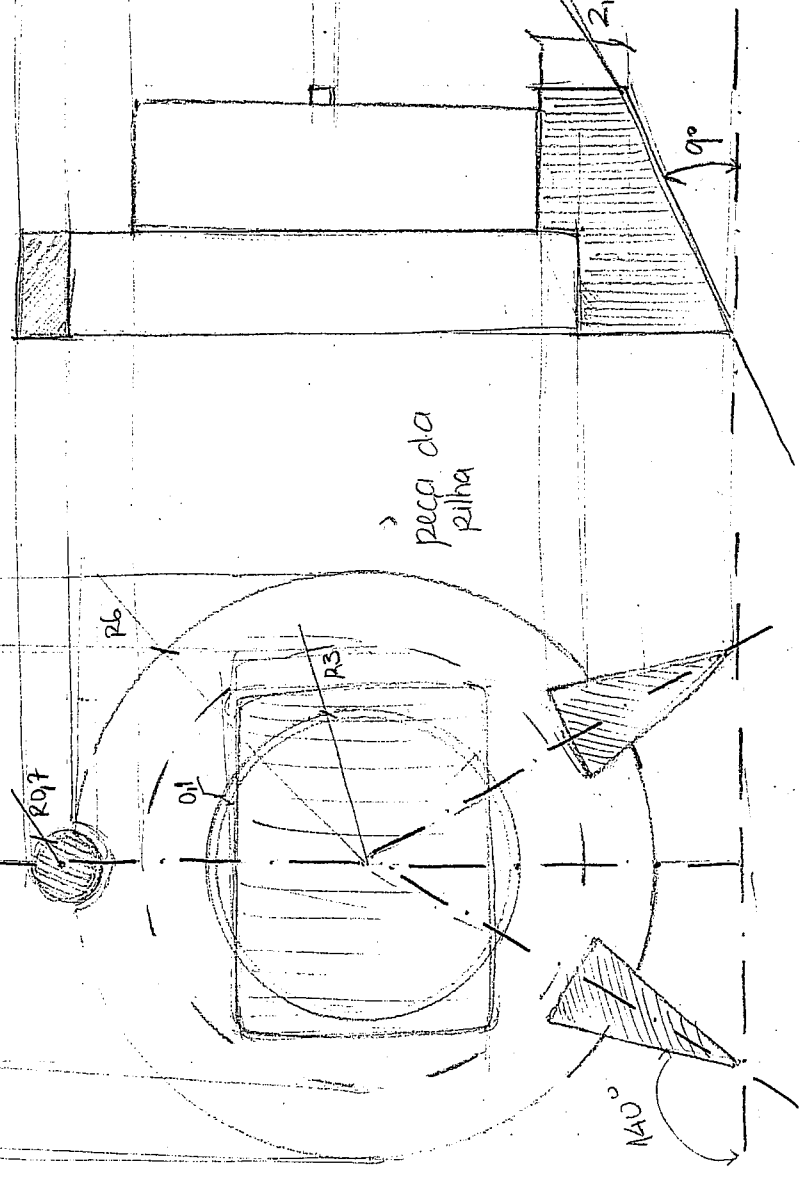

peça da
 railha

Unidades : cm

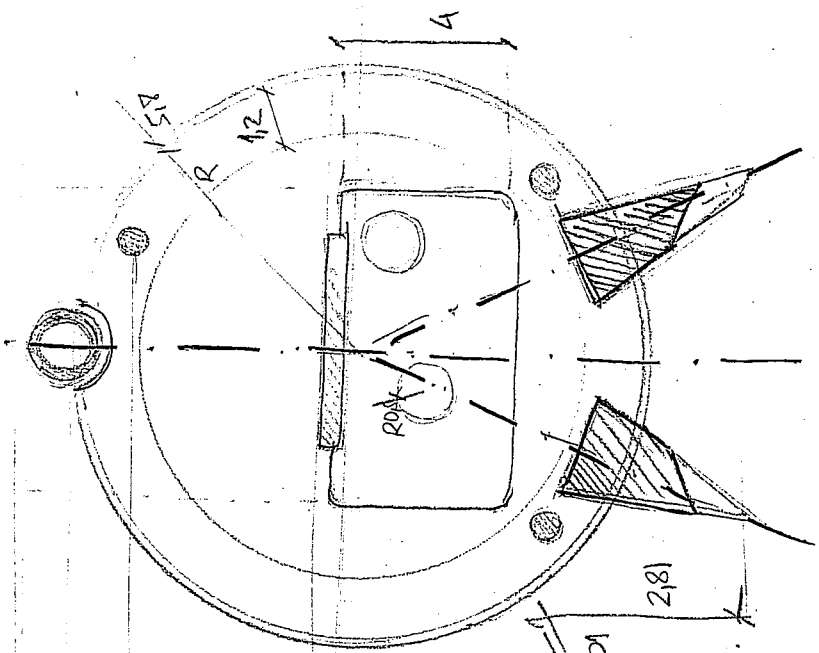
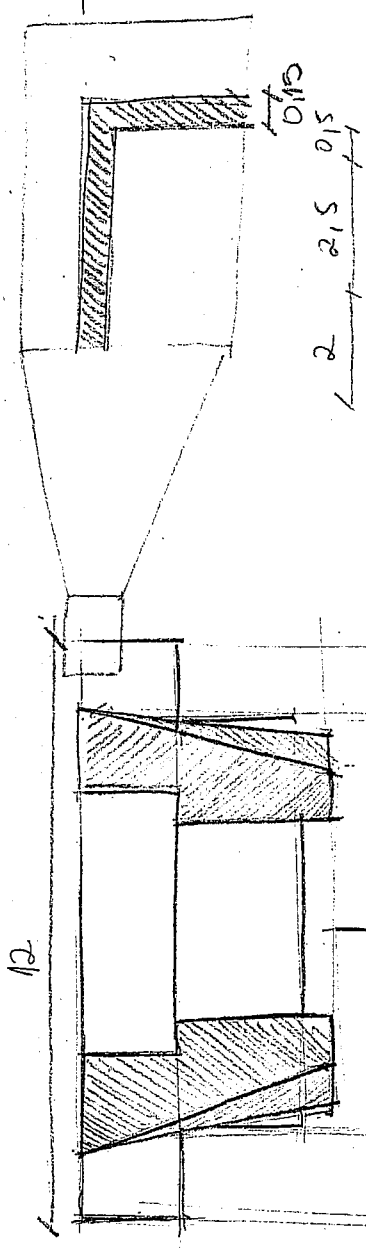
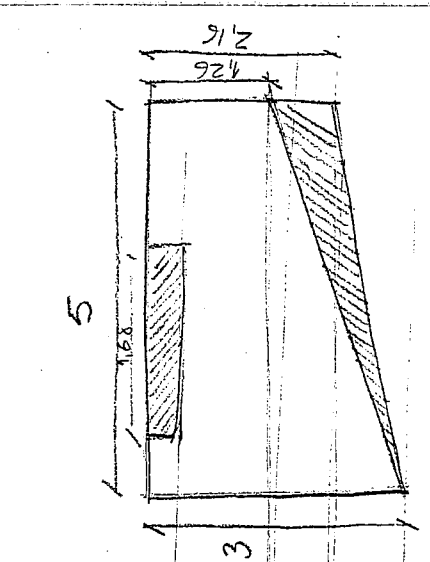
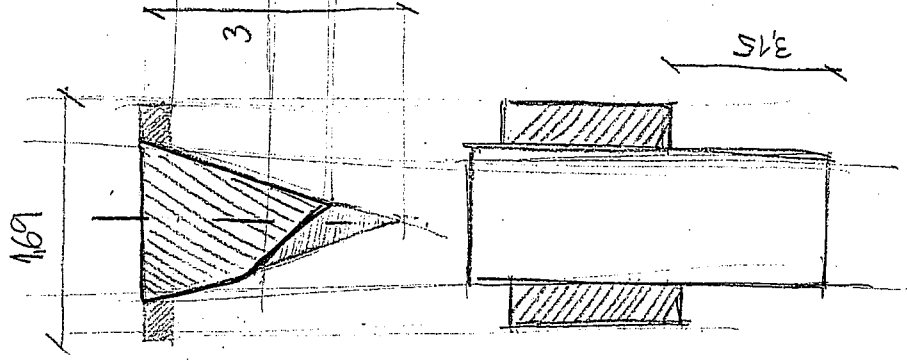
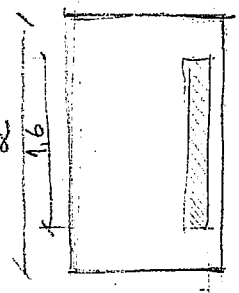
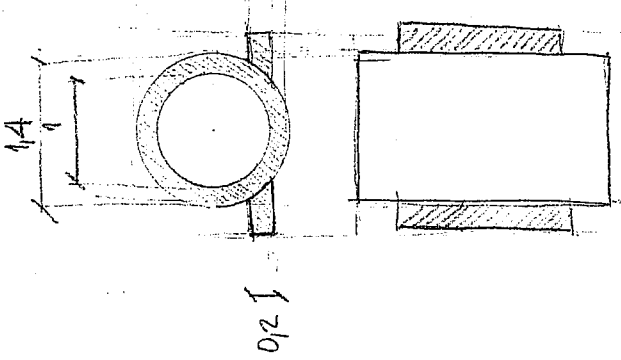

pés duplicado e
em espelho

